

Catalogo Generale

Articoli AZ

Valido dal 01.03.2021

KAUFGUT[®]

INDICE

CUCINA	6
Bollitori Pentole Padelle Coperchi	8
Friggere Cottura a vapore	28
Linea smalto	32
Tagliare Tritare Sminuzzare	46
Grattugiare Affettare Sbucciare Passare	64
Girare Mescolare Battere	76
Aprire Chiudere	79
Mantenere Fresco Conservazione	83
Snocciolare Sterilizzare	92
Imbuti Colini	99
Altri Accessori Cucina	106
Carne Pesce Crostacei	113
Pasta Gnocchetti Pizza	118
Gadget Utensili Da Cucina	121
PASTICCERIA	136
Tortiere Stampi	138
Taglia biscotti	147
Pennelli Spatole cucchiali	156
Grattugiare Macinare	160
Mescolare Sbattere Dosare	162
Decorare Guarnire Porzionare	170
Setacciare Spargere Stendere	178
Trasportare Conservare	181
A TAVOLA	186
Caffè The	188
Fondute Cioccolatiere Accessori	203
Aceto Olio Sale Pepe Spezie	207
Vino Bar Versatori	215
Accessori Tavola Servire	225

Servizi Piatti Posate Tazze	239
Bicchieri Caraffe Decanter Bottiglie Vetro	249
Tovaglioli	254
BILANCE E PESAPERSONE	271
Bilance Da Cucina Analogiche	273
Bilance Da Cucina Digitali	275
Pesapersona Analogiche	279
Pesapersona Digitali	281
Pesapacchi	283
Bilance Speciali	285
PICCOLI ELETTRODOMESTICI	287
Frullare Mescolare Impastare	289
Tritare Grattugiare Spremere	292
Essicare Cottura a vapore	295
Raclette Grill Fondute Toaster Waffel Bistecchiere	297
Microonde Friggitrice Forni	301
Macchine Da Caffè Bolliacqua	303
Stirare Cura Della Persona	306
Piastrre Elettriche Induzione	313
Attrezzature Speciali	315
CASA GIARDINO TEMPO LIBERO	318
Grill Barbecue	320
Campeggio Trekking	323
Giardino	332
Pattumiere Pattumiere Differenziate	337
Pulire Spazzolare	341
Bottiglie Isolanti Portavivande	348
Arredobagno	361
Biancheria Appendiabiti Stirare	364
Arredare Sistemare	368
Benessere	377
RICAMBI	382
Generici	384

KAUFGUT[®]



Cucina - Kochen

Bollitori Pentole Padelle Coperchi



ART	BARCODE	ST.	PREZZO
01 02 40	4032525705203		53,00

PADELLA BASSA "TITANIUM NOWO" Ø 20 CM WOLL

UV1	UV2	IMBALLO
1	2	1/10 SL



4 0 3 2 5 2 5 7 0 5 2 0 3



ART	BARCODE	ST.	PREZZO
01 02 41	4032525705241		61,00

PADELLA BASSA "TITANIUM NOWO" Ø 24 CM WOLL

UV1	UV2	IMBALLO
1	2	1/6 SL



4 0 3 2 5 2 5 7 0 5 2 4 1



ART	BARCODE	ST.	PREZZO
01 02 42	4032525705265		66,50

PADELLA BASSA "TITANIUM NOWO" Ø 26 CM WOLL

UV1	UV2	IMBALLO
1	2	1/6 SL



4 0 3 2 5 2 5 7 0 5 2 6 5



ART	BARCODE	ST.	PREZZO
01 02 43	4032525705289		71,00

PADELLA BASSA "TITANIUM NOWO" Ø 28 CM WOLL

UV1	UV2	IMBALLO
1	2	1/6 SL



4 0 3 2 5 2 5 7 0 5 2 8 9



ART	BARCODE	ST.	PREZZO
01 02 44	4032525705326		81,50

PADELLA BASSA "TITANIUM NOWO" Ø 32 CM WOLL

UV1	UV2	IMBALLO
1	2	1/3 SL



4 0 3 2 5 2 5 7 0 5 3 2 6



ART	BARCODE	ST.	PREZZO
01 02 46	4032525717244		72,50

PADELLA FONDA "TITANIUM NOWO" MANICO ASPORTABILE Ø24CM WOLL

UV1	UV2	IMBALLO
1	2	1/4 SL



4 0 3 2 5 2 5 7 1 7 2 4 4



ART	BARCODE	ST.	PREZZO
01 02 47	4032525717268		77,50

PADELLA FONDA "TITANIUM NOWO" MANICO ASPORTABILE Ø26 CM WOLL

UV1	UV2	IMBALLO
1	2	1/4 SL



4 0 3 2 5 2 5 7 1 7 2 6 8



ART	BARCODE	ST.	PREZZO
01 02 48	4032525717282		81,00

PADELLA FONDA "TITANIUM NOWO" MANICO ASPORTABILE Ø28 CM WOLL

UV1	UV2	IMBALLO
1	2	1/4 SL



4 0 3 2 5 2 5 7 1 7 2 8 2



ART	BARCODE	ST.	PREZZO
01 02 54	4032525762831		87,00

BISTECCHIERA "TITANIUM NOWO" MANICO ASPORTABILE 28X28CM WOLL

UV1	UV2	IMBALLO
1	2	1/6 SL



4 0 3 2 5 2 5 7 6 2 8 3 1



ART	BARCODE	ST.	PREZZO
01 02 69	4032525652033		73,00

PADELLA BASSA "NOWO INDUCTION" Ø20 CM WOLL

UV1	UV2	IMBALLO
1	2	1/10 SL



4 0 3 2 5 2 5 6 5 2 0 3 3



ART	BARCODE	ST.	PREZZO
01 02 70	4032525652439		83,00

PADELLA BASSA "NOWO INDUCTION" Ø24 CM WOLL

UV1	UV2	IMBALLO
1	2	1/6 SL



4 0 3 2 5 2 5 6 5 2 4 3 9



ART	BARCODE	ST.	PREZZO
01 02 71	4032525652835		97,00

PADELLA BASSA "NOWO INDUCTION" Ø28 CM WOLL

UV1	UV2	IMBALLO
1	2	1/6 SL



4 0 3 2 5 2 5 6 5 2 8 3 5



ART	BARCODE	ST.	PREZZO
01 02 72	4032525653238		109,50

PADELLA BASSA "NOWO INDUCTION" Ø32 CM WOLL

UV1	UV2	IMBALLO
1	2	1/6 SL



4 0 3 2 5 2 5 6 5 3 2 3 8



ART	BARCODE	ST.	PREZZO
01 02 88	4032525615243		90,00

PADELLA BASSA "NOWO INDUCTION" MANICO ASPORTABILE 24 CM WOLL

UV1	UV2	IMBALLO
1	2	1/6 SL



4 0 3 2 5 2 5 6 1 5 2 4 3



ART	BARCODE	ST.	PREZZO
01 02 89	4032525615281		104,00

PADELLA BASSA "NOWO INDUCTION" MANICO ASPORTABILE 28CM WOLL

UV1	UV2	IMBALLO
1	2	1/6 SL



4 0 3 2 5 2 5 6 1 5 2 8 1



ART	BARCODE	ST.	PREZZO
01 02 90	4032525615328		117,00

PADELLA BASSA "NOWO INDUCTION" MANICO ASPORTABILE 32CM WOLL

UV1	UV2	IMBALLO
1	2	1/3 SL



4 0 3 2 5 2 5 6 1 5 3 2 8



ART	BARCODE	ST.	PREZZO
01 02 73	4032525617247		91,50

PADELLA FONDA "NOWO INDUCTION" MANICO ASPORTABILE Ø24CM WOLL

UV1	UV2	IMBALLO
1	2	1/4 SL



4 0 3 2 5 2 5 6 1 7 2 4 7



ART	BARCODE	ST.	PREZZO
01 02 74	4032525617285		107,00

PADELLA FONDA "NOWO INDUCTION" MANICO ASPORTABILE Ø28CM WOLL

UV1	UV2	IMBALLO
1	2	1/4 SL



4 0 3 2 5 2 5 6 1 7 2 8 5



ART	BARCODE	ST.	PREZZO
01 02 76	4032525612815		112,00

BISTECCHIERA "NOWO INDUCTION" MANICO ASP. 28X28CM WOLL

UV1	UV2	IMBALLO
1	2	1/6 SL



4 0 3 2 5 2 5 6 1 2 8 1 5



ART	BARCODE	ST.	PREZZO
01 02 86	4032525616240	A	98,00

PADELLA QUADRATA "NOWO INDUCTION" MANICO ASP. 24X24CM WOLL

UV1	UV2	IMBALLO
1	2	1/6 SL



4 0 3 2 5 2 5 6 1 6 2 4 0



ART	BARCODE	ST.	PREZZO
01 02 87	4032525616288		109,50

PADELLA QUADRATA "NOWO INDUCTION" MANICO ASP. 28X28CM WOLL

UV1	UV2	IMBALLO
1	2	1/6 SL



4 0 3 2 5 2 5 6 1 6 2 8 8



ART	BARCODE	ST.	PREZZO
01 02 79	4032525612037		98,00

PENTOLA "NOWO INDUCTION" Ø 20 CM WOLL

UV1	UV2	IMBALLO
1	2	1/6 BK



4 0 3 2 5 2 5 6 1 2 0 3 7



ART	BARCODE	ST.	PREZZO
01 02 80	4032525631243		112,00

PENTOLA "NOWO INDUCTION" Ø 24 CM WOLL

UV1	UV2	IMBALLO
1	2	1/4 BK



4 0 3 2 5 2 5 6 3 1 2 4 3



ART	BARCODE	ST.	PREZZO
01 02 81	4032525612839		127,50

PENTOLA "NOWO INDUCTION" Ø 28 CM WOLL

UV1	UV2	IMBALLO
1	2	1/4 BK



4 0 3 2 5 2 5 6 1 2 8 3 9



ART	BARCODE	ST.	PREZZO
01 02 77	4032525682801		107,00

CASSERUOLA "NOWO INDUCTION" Ø 28 CM WOLL

UV1	UV2	IMBALLO
1	2	1/4 SL



4 0 3 2 5 2 5 6 8 2 8 0 1



ART	BARCODE	ST.	PREZZO
01 02 78	4032525683204		125,00

CASSERUOLA 2 MANICI "NOWO INDUCTION" Ø 32 CM WOLL

UV1	UV2	IMBALLO
1	2	1/6 SL



4 0 3 2 5 2 5 6 8 3 2 0 4



ART	BARCODE	ST.	PREZZO
01 02 82	4032525611832		85,00

CASSERUOLA 1 MANICO "NOWO INDUCTION" Ø 18 CM WOLL

UV1	UV2	IMBALLO
1	2	1/8 BK



4 0 3 2 5 2 5 6 1 1 8 3 2



ART	BARCODE	ST.	PREZZO
01 02 83	4032525611368		128,00

WOK/SALTAPASTA 2 MANICI "NOWO INDUCTION" Ø 36CM WOLL

UV1	UV2	IMBALLO
1	2	1/4 BK



4 0 3 2 5 2 5 6 1 1 3 6 8



ART	BARCODE	ST.	PREZZO
01 02 91	4054359009661		118,00

PADELLA WOK MANICO LUNGO "NOWO INDUCTION" Ø 32CM WOLL

UV1	UV2	IMBALLO
1	2	1/4 BK



4 0 5 4 3 5 9 0 0 9 6 6 1



ART	BARCODE	ST.	PREZZO
01 10 35	4032525100206		13,50

COPERCHIO ROTONDO VETRO SICUREZZA Ø 20 CM WOLL

UV1	UV2	IMBALLO
1	2	1/20 SL



4 0 3 2 5 2 5 1 0 0 2 0 6



ART	BARCODE	ST.	PREZZO
01 10 36	4032525100244		14,50

COPERCHIO ROTONDO VETRO SICUREZZA Ø 24 CM WOLL

UV1	UV2	IMBALLO
1	2	1/8 SL



4 0 3 2 5 2 5 1 0 0 2 4 4



ART	BARCODE	ST.	PREZZO
01 10 37	4032525100268		15,50

COPERCHIO ROTONDO VETRO SICUREZZA Ø 26 CM WOLL

UV1	UV2	IMBALLO
1	2	1/10 SL



4 0 3 2 5 2 5 1 0 0 2 6 8



ART	BARCODE	ST.	PREZZO
01 10 38	4032525100282		16,50

COPERCHIO ROTONDO VETRO SICUREZZA Ø 28 CM WOLL

UV1	UV2	IMBALLO
1	2	1/7 SL



4 0 3 2 5 2 5 1 0 0 2 8 2



ART	BARCODE	ST.	PREZZO
01 10 39	4032525100329		17,50

COPERCHIO ROTONDO VETRO SICUREZZA Ø 32 CM WOLL

UV1	UV2	IMBALLO
1	6	1/7 SL



4 0 3 2 5 2 5 1 0 0 3 2 9



ART	BARCODE	ST.	PREZZO
01 10 49	4032525102286		25,00

COPERCHIO QUADRATO VETRO SICUREZZA 28X28 CM WOLL

UV1	UV2	IMBALLO
1	5	1/7 SL



4 0 3 2 5 2 5 1 0 2 2 8 6



ART	BARCODE	ST.	PREZZO
01 10 96	4032525400207	A	15,00

COPERCHIO 'LOGIC' VETRO/ACCIAIO INOSSIDABILE Ø 20 CM WOLL

UV1	UV2	IMBALLO
1	6	1/6 PG



4 0 3 2 5 2 5 4 0 0 2 0 7



ART	BARCODE	ST.	PREZZO
01 11 80	4005643457125		34,00

**PADELLA BASSA "TITANIUM GRANIT"
INDUZIONE Ø20CM GSW**

UV1	UV2	IMBALLO
1	3	1/6 SL



4 0 0 5 6 4 3 4 5 7 1 2 5



ART	BARCODE	ST.	PREZZO
01 11 81	4005643457149		39,50

**PADELLA BASSA "TITANIUM GRANIT"
INDUZIONE Ø24CM GSW**

UV1	UV2	IMBALLO
1	3	1/6 SL



4 0 0 5 6 4 3 4 5 7 1 4 9



ART	BARCODE	ST.	PREZZO
01 11 82	4005643457187		47,00

**PADELLA BASSA "TITANIUM GRANIT"
INDUZIONE Ø28CM GSW**

UV1	UV2	IMBALLO
1	3	1/6 SL



4 0 0 5 6 4 3 4 5 7 1 8 7



ART	BARCODE	ST.	PREZZO
01 11 83	4005643457132		59,50

**PADELLA BASSA TITANIUM GRANIT
'FERROTHERM' Ø32CM GSW**

UV1	UV2	IMBALLO
1	3	1/6 SL



4 0 0 5 6 4 3 4 5 7 1 3 2



ART	BARCODE	ST.	PREZZO
01 11 85	4005643457248	A	47,00

**PADELLA ALTA "TITANIUM GRANIT"
INDUZIONE Ø24CM GSW**

UV1	UV2	IMBALLO
1	3	1/6 SL



4 0 0 5 6 4 3 4 5 7 2 4 8



ART	BARCODE	ST.	PREZZO
01 11 86	4005643457286	A	56,50

**PADELLA ALTA "TITANIUM GRANIT"
INDUZIONE Ø28CM GSW**

UV1	UV2	IMBALLO
1	3	1/6 SL



4 0 0 5 6 4 3 4 5 7 2 8 6



ART	BARCODE	ST.	PREZZO
01 11 87	4005643457293	A	55,00

**PADELLA GRILL "TITANIUM GRANIT"
INDUZIONE 28X28CM GSW**

UV1	UV2	IMBALLO
1	3	1/6 SL



4 0 0 5 6 4 3 4 5 7 2 9 3



ART	BARCODE	ST.	PREZZO
01 12 20	4005643458306		22,50

**PADELLA "SILCOGUSS" INDUZIONE
20CM GSW**

UV1	UV2	IMBALLO
1	2	1/6 SL



4 0 0 5 6 4 3 4 5 8 3 0 6



ART	BARCODE	ST.	PREZZO
01 12 21	4005643458313		28,50

**PADELLA "SILCOGUSS" INDUZIONE
24CM GSW**

UV1	UV2	IMBALLO
1	2	1/6 SL



4 0 0 5 6 4 3 4 5 8 3 1 3



ART	BARCODE	ST.	PREZZO
01 12 22	4005643458320		35,50

**PADELLA "SILCOGUSS" INDUZIONE
28CM GSW**

UV1	UV2	IMBALLO
1	2	1/6 SL



4 0 0 5 6 4 3 4 5 8 3 2 0



ART	BARCODE	ST.	PREZZO
01 12 23	4005643458337		39,50

**PADELLA "SILCOGUSS" INDUZIONE
32CM GSW**

UV1	UV2	IMBALLO
1	2	1/6 SL



4 0 0 5 6 4 3 4 5 8 3 3 7



ART	BARCODE	ST.	PREZZO
01 12 30	4005643458351		42,50

**BISTECCHIERA "SILCOGUSS" INDUZIONE
28X28CM GSW**

UV1	UV2	IMBALLO
1	2	1/6 SL



4 0 0 5 6 4 3 4 5 8 3 5 1



ART	BARCODE	ST.	PREZZO
01 12 14	4005643458160		25,50

PENTOLA CON COPERCHIO
"SILCOGUSS" INDUZIONE 16CM GSW

UV1	UV2	IMBALLO
1	2	1/2/6 SP



4 0 0 5 6 4 3 4 5 8 1 6 0



ART	BARCODE	ST.	PREZZO
01 12 15	4005643458207		33,50

PENTOLA CON COPERCHIO
"SILCOGUSS" INDUZIONE 20CM GSW

UV1	UV2	IMBALLO
1	2	1/6 SP



4 0 0 5 6 4 3 4 5 8 2 0 7



ART	BARCODE	ST.	PREZZO
01 12 16	4005643458245		43,00

PENTOLA CON COPERCHIO
"SILCOGUSS" INDUZIONE 24CM GSW

UV1	UV2	IMBALLO
1	2	1/6 SP



4 0 0 5 6 4 3 4 5 8 2 4 5



ART	BARCODE	ST.	PREZZO
01 12 17	4005643458283		54,00

PENTOLA CON COPERCHIO
"SILCOGUSS" INDUZIONE 28CM GSW

UV1	UV2	IMBALLO
1	2	1/6 SP



4 0 0 5 6 4 3 4 5 8 2 8 3



ART	BARCODE	ST.	PREZZO
01 12 26	4005643458108		41,00

ROSTIERA CON COPERCHIO
"SILCOGUSS" INDUZIONE 24CM GSW

UV1	UV2	IMBALLO
1	2	1/6 SP



4 0 0 5 6 4 3 4 5 8 1 0 8



ART	BARCODE	ST.	PREZZO
01 12 19	4005643458269		28,00

CASSERUOLA 1 MANICO "SILCOGUSS"
INDUZIONE 16CM GSW

UV1	UV2	IMBALLO
1	2	1/2/6 SP



4 0 0 5 6 4 3 4 5 8 2 6 9



ART	BARCODE	ST.	PREZZO
01 29 01	8004537129014		18,50

CASSERUOLA+COP.'MADEIRA' INOX 18/8
INDUZIONE 14CM EVA

UV1	UV2	IMBALLO
1	8	1/8 PB



8 0 0 4 5 3 7 1 2 9 0 1 4



ART	BARCODE	ST.	PREZZO
01 29 02	8004537129021		20,50

CASSERUOLA+COP.'MADEIRA' INOX 18/8
INDUZIONE 16CM EVA

UV1	UV2	IMBALLO
1	6	1/6 PB



8 0 0 4 5 3 7 1 2 9 0 2 1



ART	BARCODE	ST.	PREZZO
01 29 03	8004537129038		24,00

CASSERUOLA+COP.'MADEIRA' INOX 18/8
INDUZIONE 18CM EVA

UV1	UV2	IMBALLO
1	4	1/4 PB



8 0 0 4 5 3 7 1 2 9 0 3 8



ART	BARCODE	ST.	PREZZO
01 29 04	8004537129045		27,00

CASSERUOLA+COP.'MADEIRA' INOX 18/8
INDUZIONE 20CM EVA

UV1	UV2	IMBALLO
1	4	1/4 PB



8 0 0 4 5 3 7 1 2 9 0 4 5



ART	BARCODE	ST.	PREZZO
01 29 05	8004537129052		31,50

CASSERUOLA+COP.'MADEIRA' INOX 18/8
INDUZIONE 22CM EVA

UV1	UV2	IMBALLO
1	4	1/4 PB



8 0 0 4 5 3 7 1 2 9 0 5 2



ART	BARCODE	ST.	PREZZO
01 29 06	8004537129069		36,00

CASSERUOLA+COP.'MADEIRA' INOX 18/8
INDUZIONE 24CM EVA

UV1	UV2	IMBALLO
1	4	1/4 PB



8 0 0 4 5 3 7 1 2 9 0 6 9



ART	BARCODE	ST.	PREZZO
01 29 10	8004537129106		39,50

**PENTOLA+COP. 'MADEIRA' INOX 18/8
INDUZIONE 22CM EVA**

UV1	UV2	IMBALLO
1	4	1/4 PB



8 0 0 4 5 3 7 1 2 9 1 0 6



ART	BARCODE	ST.	PREZZO
01 29 15	8004537129151	A	24,00

**PADELLA 'MADEIRA' INOX 18/8
INDUZIONE 24CM EVA**

UV1	UV2	IMBALLO
1	6	1/6 SL



8 0 0 4 5 3 7 1 2 9 1 5 1



ART	BARCODE	ST.	PREZZO
01 29 11	8004537129113		14,50

**CASSERUOLA 1 MANICO 'MADEIRA' INOX
18/8 INDUZIONE 14CM EVA**

UV1	UV2	IMBALLO
1	6	1/6 PB



8 0 0 4 5 3 7 1 2 9 1 1 3



ART	BARCODE	ST.	PREZZO
01 29 12	8004537129120		16,50

**CASSERUOLA 1 MANICO 'MADEIRA' INOX
18/8 INDUZIONE 16CM EVA**

UV1	UV2	IMBALLO
1	6	1/6 PB



8 0 0 4 5 3 7 1 2 9 1 2 0



ART	BARCODE	ST.	PREZZO
01 29 13	8004537129137	A	18,00

**CASSERUOLA 1 MANICO 'MADEIRA' INOX
18/8 INDUZIONE 18CM EVA**

UV1	UV2	IMBALLO
1	6	1/6 PB



8 0 0 4 5 3 7 1 2 9 1 3 7



ART	BARCODE	ST.	PREZZO
01 29 20	8004537129205		17,00

**PIGNATTA 'MADEIRA' INOX 18/8
INDUZIONE 11CM EVA**

UV1	UV2	IMBALLO
1	4	1/4/16 CL



8 0 0 4 5 3 7 1 2 9 2 0 5



ART	BARCODE	ST.	PREZZO
01 29 21	8004537129212		18,50

**PIGNATTA 'MADEIRA' INOX 18/8
INDUZIONE 12CM EVA**

UV1	UV2	IMBALLO
1	4	1/4/16 CL



8 0 0 4 5 3 7 1 2 9 2 1 2



ART	BARCODE	ST.	PREZZO
01 29 19	8004537129199		21,50

**PIGNATTA 'MADEIRA' INOX 18/8
INDUZIONE 14CM EVA**

UV1	UV2	IMBALLO
1	4	1/4/16 CL



8 0 0 4 5 3 7 1 2 9 1 9 9



ART	BARCODE	ST.	PREZZO
01 29 22	8004537129229		24,50

**PIGNATTA 'MADEIRA' INOX 18/8
INDUZIONE 16CM EVA**

UV1	UV2	IMBALLO
1	4	1/4/16 CL



8 0 0 4 5 3 7 1 2 9 2 2 9



ART	BARCODE	ST.	PREZZO
01 30 68	4005643860444	A	86,50

PADELLA GASTRO PLATINUM 40CM GSW

UV1	UV2	IMBALLO
1	2	1/4 SL



4 0 0 5 6 4 3 8 6 0 4 4 4



ART	BARCODE	ST.	PREZZO
01 30 62	4005643975339		45,00

**PADELLA GASTRO INOX 3-PLY
INDUZIONE 24CM GSW**

UV1	UV2	IMBALLO
1	2	1/6 SL



4 0 0 5 6 4 3 9 7 5 3 3 9



ART	BARCODE	ST.	PREZZO
01 30 63	4005643975346		53,50

**PADELLA GASTRO INOX 3-PLY
INDUZIONE 28CM GSW**

UV1	UV2	IMBALLO
1	2	1/6 SL



4 0 0 5 6 4 3 9 7 5 3 4 6



ART	BARCODE	ST.	PREZZO
01 30 64	4005643975353		62,50

PADELLA GASTRO INOX 3-PLY
INDUZIONE 32CM GSW

UV1	UV2	IMBALLO
1	2	1/6 SL



4 0 0 5 6 4 3 9 7 5 3 5 3



ART	BARCODE	ST.	PREZZO
01 30 24	4005643134156	A	39,50

TEGAME+COPERCHIO ACCIAIO INOSSID
'TITANA' INDUZIONE 20CM GSW

UV1	UV2	IMBALLO
1	2	1/2/6 SP



4 0 0 5 6 4 3 1 3 4 1 5 6



ART	BARCODE	ST.	PREZZO
01 30 26	4005643134118	A	31,50

PENTOLA+COPERCHIO ACCIAIO INOSS
'TITANA' INDUZIONE 16CM GSW

UV1	UV2	IMBALLO
1	2	1/2/6 SP



4 0 0 5 6 4 3 1 3 4 1 1 8



ART	BARCODE	ST.	PREZZO
01 30 27	4005643134125	A	42,50

PENTOLA+COPERCHIO ACCIAIO INOSS
'TITANA' INDUZIONE 20CM GSW

UV1	UV2	IMBALLO
1	2	1/2/6 SP



4 0 0 5 6 4 3 1 3 4 1 2 5



ART	BARCODE	ST.	PREZZO
01 30 28	4005643134132	A	52,50

PENTOLA+COPERCHIO ACCIAIO INOSS
'TITANA' INDUZIONE 24CM GSW

UV1	UV2	IMBALLO
1	2	1/2/4 SP



4 0 0 5 6 4 3 1 3 4 1 3 2



ART	BARCODE	ST.	PREZZO
01 30 29	4005643134149	A	68,50

PENTOLA+COPERCHIO ACCIAIO INOSS
'TITANA' INDUZIONE 28CM GSW

UV1	UV2	IMBALLO
1	2	1/2/4 SP



4 0 0 5 6 4 3 1 3 4 1 4 9



ART	BARCODE	ST.	PREZZO
01 30 30	4005643978200		32,50

CASSERUOLA SENZA COP GASTRO INOX
INDUZIONE 20CM-2,5L GSW

UV1	UV2	IMBALLO
1	2	1/6 AL



4 0 0 5 6 4 3 9 7 8 2 0 0



ART	BARCODE	ST.	PREZZO
01 30 31	4005643978248		39,50

CASSERUOLA SENZA COP GASTRO INOX
INDUZIONE 24CM-4,0L GSW

UV1	UV2	IMBALLO
1	2	1/6 AL



4 0 0 5 6 4 3 9 7 8 2 4 8



ART	BARCODE	ST.	PREZZO
01 30 32	4005643978286		57,50

CASSERUOLA SENZA COP GASTRO INOX
INDUZIONE 28CM-6,5L GSW

UV1	UV2	IMBALLO
1	2	1/4 AL



4 0 0 5 6 4 3 9 7 8 2 8 6



ART	BARCODE	ST.	PREZZO
01 30 33	4005643978323		79,50

CASSERUOLA SENZA COP GASTRO INOX
INDUZIONE 32CM-11L GSW

UV1	UV2	IMBALLO
1	2	1/2 AL



4 0 0 5 6 4 3 9 7 8 3 2 3



ART	BARCODE	ST.	PREZZO
01 30 34	4005643971362		121,00

CASSERUOLA CON COP GASTRO INOX
INDUZIONE 36CM-17,4L GSW

UV1	UV2	IMBALLO
1	2	1/1 AL



4 0 0 5 6 4 3 9 7 1 3 6 2



ART	BARCODE	ST.	PREZZO
01 30 35	4005643971409		153,00

CASSERUOLA CON COP GASTRO INOX
INDUZIONE 40CM-24,0L GSW

UV1	UV2	IMBALLO
1	2	1/1 AL



4 0 0 5 6 4 3 9 7 1 4 0 9



ART	BARCODE	ST.	PREZZO
01 30 36	4005643979160		29,50

PENTOLA SENZA COPERCHIO GASTRO INOX INDUZIONE 16CM-2,3L GSW

UV1	UV2	IMBALLO
1	2	1/6 AL



4 0 0 5 6 4 3 9 7 9 1 6 0



ART	BARCODE	ST.	PREZZO
01 30 37	4005643979207		37,50

PENTOLA SENZA COPERCHIO GASTRO INOX INDUZIONE 20CM-4,2L GSW

UV1	UV2	IMBALLO
1	2	1/6 AL



4 0 0 5 6 4 3 9 7 9 2 0 7



ART	BARCODE	ST.	PREZZO
01 30 38	4005643979245		47,50

PENTOLA SENZA COPERCHIO GASTRO INOX INDUZIONE 24CM-6,8L GSW

UV1	UV2	IMBALLO
1	2	1/4 AL



4 0 0 5 6 4 3 9 7 9 2 4 5



ART	BARCODE	ST.	PREZZO
01 30 39	4005643979283		68,50

PENTOLA SENZA COPERCHIO GASTRO INOX INDUZIONE 28CM-10,0L GSW

UV1	UV2	IMBALLO
1	2	1/4 AL



4 0 0 5 6 4 3 9 7 9 2 8 3



ART	BARCODE	ST.	PREZZO
01 30 40	4005643979320		86,00

PENTOLA SENZA COPERCHIO GASTRO INOX INDUZIONE 32CM-14,0L GSW

UV1	UV2	IMBALLO
1	2	1/2 AL



4 0 0 5 6 4 3 9 7 9 3 2 0



ART	BARCODE	ST.	PREZZO
01 30 41	4005643979368		32,50

PENTOLA FONDA SENZA COP GASTRO INOX INDUZIONE 16CM-2,9L GSW

UV1	UV2	IMBALLO
1	2	1/6 AL



4 0 0 5 6 4 3 9 7 9 3 6 8



ART	BARCODE	ST.	PREZZO
01 30 42	4005643979405		42,50

PENTOLA FONDA SENZA COP GASTRO INOX INDUZIONE 20CM-5,3L GSW

UV1	UV2	IMBALLO
1	2	1/6 AL



4 0 0 5 6 4 3 9 7 9 4 0 5



ART	BARCODE	ST.	PREZZO
01 30 43	4005643979443		54,00

PENTOLA FONDA SENZA COP GASTRO INOX INDUZIONE 24CM-9,0L GSW

UV1	UV2	IMBALLO
1	2	1/4 AL



4 0 0 5 6 4 3 9 7 9 4 4 3



ART	BARCODE	ST.	PREZZO
01 30 44	4005643979481		79,50

PENTOLA FONDA SENZA COP GASTRO INOX INDUZIONE 28CM-13,5L GSW

UV1	UV2	IMBALLO
1	2	1/4 AL



4 0 0 5 6 4 3 9 7 9 4 8 1



ART	BARCODE	ST.	PREZZO
01 30 45	4005643979528		110,00

PENTOLA FONDA SENZA COP GASTRO INOX INDUZIONE 32CM-21,0L GSW

UV1	UV2	IMBALLO
1	2	1/2 AL



4 0 0 5 6 4 3 9 7 9 5 2 8



ART	BARCODE	ST.	PREZZO
01 30 47	4005643973403		209,00

PENTOLA FONDA CON COP GASTRO INOX INDUZIONE 40CM-50,0L GSW

UV1	UV2	IMBALLO
1	2	1/1 AL



4 0 0 5 6 4 3 9 7 3 4 0 3



ART	BARCODE	ST.	PREZZO
01 30 55	4005643974165		26,00

CASSERUOLA 1 MANICO GASTRO INOX INDUZIONE 16CM-1,4L GSW

UV1	UV2	IMBALLO
1	2	1/6 AL



4 0 0 5 6 4 3 9 7 4 1 6 5



ART	BARCODE	ST.	PREZZO
01 30 56	4005643974189		28,00

CASSERUOLA 1 MANICO GASTRO INOX INDUZIONE 18CM-1,9L GSW

UV1	UV2	IMBALLO
1	2	1/6 AL



4 0 0 5 6 4 3 9 7 4 1 8 9



ART	BARCODE	ST.	PREZZO
01 30 57	4005643974202		33,50

CASSERUOLA 1 MANICO GASTRO INOX INDUZIONE 20CM-2,3L GSW

UV1	UV2	IMBALLO
1	2	1/6 AL



4 0 0 5 6 4 3 9 7 4 2 0 2



ART	BARCODE	ST.	PREZZO
01 30 58	4005643976169		23,50

SAUTEUSE GASTRO INOX INDUZIONE 16CM-1,0L GSW

UV1	UV2	IMBALLO
1	2	1/6 AL



4 0 0 5 6 4 3 9 7 6 1 6 9



ART	BARCODE	ST.	PREZZO
01 30 59	4005643976183		26,00

SAUTEUSE GASTRO INOX INDUZIONE 18CM-1,4L GSW

UV1	UV2	IMBALLO
1	2	1/6 AL



4 0 0 5 6 4 3 9 7 6 1 8 3



ART	BARCODE	ST.	PREZZO
01 30 60	4005643976206		29,50

SAUTEUSE GASTRO INOX INDUZIONE 20CM-2,0L GSW

UV1	UV2	IMBALLO
1	2	1/6 AL



4 0 0 5 6 4 3 9 7 6 2 0 6



ART	BARCODE	ST.	PREZZO
01 30 61	4005643976244		37,50

SAUTEUSE GASTRO INOX INDUZIONE 24CM-3,1L GSW

UV1	UV2	IMBALLO
1	2	1/6 AL



4 0 0 5 6 4 3 9 7 6 2 4 4



ART	BARCODE	ST.	PREZZO
01 30 71	4005643133166		9,00

COPERCHIO GASTRO INOX 16CM GSW

UV1	UV2	IMBALLO
1	2	1/6 SL



4 0 0 5 6 4 3 1 3 3 1 6 6



ART	BARCODE	ST.	PREZZO
01 30 72	4005643133203		12,00

COPERCHIO GASTRO INOX 20CM GSW

UV1	UV2	IMBALLO
1	2	1/6 SL



4 0 0 5 6 4 3 1 3 3 2 0 3



ART	BARCODE	ST.	PREZZO
01 30 73	4005643133241		15,50

COPERCHIO GASTRO INOX 24CM GSW

UV1	UV2	IMBALLO
1	2	1/6 SL



4 0 0 5 6 4 3 1 3 3 2 4 1



ART	BARCODE	ST.	PREZZO
01 30 74	4005643133289		20,50

COPERCHIO GASTRO INOX 28CM GSW

UV1	UV2	IMBALLO
1	2	1/6 SL



4 0 0 5 6 4 3 1 3 3 2 8 9



ART	BARCODE	ST.	PREZZO
01 30 75	4005643133326		24,50

COPERCHIO GASTRO INOX 32CM GSW

UV1	UV2	IMBALLO
1	2	1/6 SL



4 0 0 5 6 4 3 1 3 3 3 2 6



ART	BARCODE	ST.	PREZZO
01 30 76	4005643133364		34,50

COPERCHIO GASTRO INOX 36CM GSW

UV1	UV2	IMBALLO
1	2	1/10 PG



4 0 0 5 6 4 3 1 3 3 3 6 4



ART	BARCODE	ST.	PREZZO
01 30 77	4005643133401		42,00

COPERCHIO GASTRO INOX 40CM GSW

UV1	UV2	IMBALLO
1	2	1/10 PG



4 0 0 5 6 4 3 1 3 3 4 0 1



ART	BARCODE	ST.	PREZZO
01 09 94	4005643411400		14,80

COPERCHIO UNIVERSALE VETRO Ø 24/26/28 CM GSW

UV1	UV2	IMBALLO
1	6	1/6 SL



4 0 0 5 6 4 3 4 1 1 4 0 0



ART	BARCODE	ST.	PREZZO
01 31 88	4005643990042		49,90

4 PEZZI SET PENTOLE 'MONTREAL' ACCIAIO INOX INDUZIONE GSW

UV1	UV2	IMBALLO
1	3	1/1 PB



4 0 0 5 6 4 3 9 9 0 0 4 2



ART	BARCODE	ST.	PREZZO
01 31 89	4005643990097		79,50

10 PEZZI SET PENTOLE 'MONTREAL' ACCIAIO INOX INDUZIONE GSW

UV1	UV2	IMBALLO
1	3	1/1 PB



4 0 0 5 6 4 3 9 9 0 0 9 7



ART	BARCODE	ST.	PREZZO
01 33 14	4005643868389		149,50

9 PEZZI SET PENTOLE 'MERAN' ACCIAIO INOX INDUZIONE GSW

UV1	UV2	IMBALLO
1	2	1/2 PB



4 0 0 5 6 4 3 8 6 8 3 8 9



ART	BARCODE	ST.	PREZZO
01 33 13	4005643806558		49,90

5 PEZZI SET PENTOLE+4 COP ACCIAIO INOX INDUZIONE GSW

UV1	UV2	IMBALLO
1	2	1/2 PB



4 0 0 5 6 4 3 8 0 6 5 5 8



ART	BARCODE	ST.	PREZZO
01 33 10	4005643806787		110,00

10 PEZZI SET PENTOLE ACCIAIO INOX 'TRENTINO' INDUZIONE GSW

UV1	UV2	IMBALLO
1	2	1/1 PB



4 0 0 5 6 4 3 8 0 6 7 8 7



ART	BARCODE	ST.	PREZZO
01 31 87	4005643990196		24,50

PENTOLA+COPERCHIO 'MONTREAL' INOX INDUZIONE 10L Ø22CM GSW

UV1	UV2	IMBALLO
1	6	1/6 SP



4 0 0 5 6 4 3 9 9 0 1 9 6



ART	BARCODE	ST.	PREZZO
01 30 89	4005643643450		42,50

PENTOLA+COPERCHIO JUMBO INOX INDUZIONE 12L 28X19CM GSW

UV1	UV2	IMBALLO
1	2	1/2 SP



4 0 0 5 6 4 3 6 4 3 4 5 0



ART	BARCODE	ST.	PREZZO
01 30 91	4005643643443		54,00

PENTOLA+COPERCHIO JUMBO INOX INDUZIONE 17L 30X24CM GSW

UV1	UV2	IMBALLO
1	2	1/2 SP



4 0 0 5 6 4 3 6 4 3 4 4 3



ART	BARCODE	ST.	PREZZO
01 30 92	4005643643474	A	59,50

PENTOLA+COPERCHIO JUMBO INOX INDUZIONE 20L 30X28CM GSW

UV1	UV2	IMBALLO
1	2	1/2 SP



4 0 0 5 6 4 3 6 4 3 4 7 4



ART	BARCODE	ST.	PREZZO
01 05 53	4005643671385		49,90

PENTOLA A PRESSIONE INDUZIONE 'CLASSIC' 4,0L Ø 18CM GSW

UV1	UV2	IMBALLO
1	2	1/1 PB



4 0 0 5 6 4 3 6 7 1 3 8 5



ART	BARCODE	ST.	PREZZO
01 05 65	4006160110715	A	79,50

PENTOLA PRESSIONE 'STK1071' INOX
INDUZIONE 5L PROFICOOK

UV1	UV2	IMBALLO
1	2	1/2 PB



4 0 0 6 1 6 0 1 1 0 7 1 5



ART	BARCODE	ST.	PREZZO
01 05 64	9002655010749		99,90

PENTOLA A PRESSIONE 'BOLERO'
INDUZIONE 6L 22CM KELOMAT

UV1	UV2	IMBALLO
1	2	1/4 PB



9 0 0 2 6 5 5 0 1 0 7 4 9



ART	BARCODE	ST.	PREZZO
01 05 50	4005643822091	A	129,50

PENTOLA A PRESSIONE INDUZIONE
'EASY CLICK' 6L GSW

UV1	UV2	IMBALLO
1	2	1/2 PB



4 0 0 5 6 4 3 8 2 2 0 9 1



ART	BARCODE	ST.	PREZZO
01 39 55*	4005643643160		28,50

PENTOLA ASPARAGI INOX 18/8
INDUZIONE 16CM GSW

UV1	UV2	IMBALLO
1	3	1/6 SP



4 0 0 5 6 4 3 6 4 3 1 6 0



ART	BARCODE	ST.	PREZZO
01 39 59	8004537139594	A	37,50

PENTOLA CUOCI PESCE INOX 18/8
INDUZIONE 45CM EVA

UV1	UV2	IMBALLO
1	4	1/4 PB



8 0 0 4 5 3 7 1 3 9 5 9 4



ART	BARCODE	ST.	PREZZO
01 30 95	4005643975360		57,50

SET BOLLIPASTA 3 PEZZI "TREVISO"
INOX INDUZIONE 22CM GSW

UV1	UV2	IMBALLO
1	2	1/4 PB



4 0 0 5 6 4 3 9 7 5 3 6 0



ART	BARCODE	ST.	PREZZO
01 30 97	4005643815208		49,50

3 PEZZI SET CUOCIVAPORE INOX
INDUZIONE Ø 20CM GSW

UV1	UV2	IMBALLO
1	2	1/4 PB



4 0 0 5 6 4 3 8 1 5 2 0 8



ART	BARCODE	ST.	PREZZO
01 31 40*	8004537131406		10,50

CASSERUOLA BOMBATA 1 MANICO INOX
18/8 INDUZIONE 12CM EVA

UV1	UV2	IMBALLO
1	6	1/6 SL



8 0 0 4 5 3 7 1 3 1 4 0 6



ART	BARCODE	ST.	PREZZO
01 31 41	8004537131413		12,00

CASSERUOLA BOMBATA 1 MANICO INOX
18/8 INDUZIONE 14CM EVA

UV1	UV2	IMBALLO
1	6	1/6 SL



8 0 0 4 5 3 7 1 3 1 4 1 3



ART	BARCODE	ST.	PREZZO
01 31 42	8004537131420		13,50

CASSERUOLA BOMBATA 1 MANICO INOX
18/8 INDUZIONE 16CM EVA

UV1	UV2	IMBALLO
1	6	1/6 SL



8 0 0 4 5 3 7 1 3 1 4 2 0



ART	BARCODE	ST.	PREZZO
01 29 48	8004537129489		7,70

PIGNATTA ACCIAIO INOSSIDABILE 18/8
0,4L 8CM EVA

UV1	UV2	IMBALLO
1	4	1/4/24 AL



8 0 0 4 5 3 7 1 2 9 4 8 9



ART	BARCODE	ST.	PREZZO
01 29 49	8004537129496		10,80

PIGNATTA ACCIAIO INOSSIDABILE 18/8
0,6L 10CM EVA

UV1	UV2	IMBALLO
1	4	1/4/12 AL



8 0 0 4 5 3 7 1 2 9 4 9 6



ART	BARCODE	ST.	PREZZO
04 16 45	8003817000920		4,75

PIGNATTA ACCIAIO INOSSIDABILE 8CM UMBRINOX

UV1	UV2	IMBALLO
1	6	1/6 BK



8 0 0 3 8 1 7 0 0 0 9 2 0



ART	BARCODE	ST.	PREZZO
04 16 47	8003817000944		5,50

PIGNATTA ACCIAIO INOSSIDABILE 10CM UMBRINOX

UV1	UV2	IMBALLO
1	6	1/6 BK



8 0 0 3 8 1 7 0 0 0 9 4 4



ART	BARCODE	ST.	PREZZO
04 16 48	8003817000951		7,50

PIGNATTA ACCIAIO INOSSIDABILE INDUZIONE 12CM UMBRINOX

UV1	UV2	IMBALLO
1	6	1/6 BK



8 0 0 3 8 1 7 0 0 0 9 5 1



ART	BARCODE	ST.	PREZZO
04 16 49	8003817000968		9,90

PIGNATTA ACCIAIO INOSSIDABILE INDUZIONE 14CM UMBRINOX

UV1	UV2	IMBALLO
1	4	1/4 BK



8 0 0 3 8 1 7 0 0 0 9 6 8



ART	BARCODE	ST.	PREZZO
01 13 30	9002655015249		32,50

PIGNATTA ACCIAIO INOX/ANTIAD. "PERFEKT" INDUZ. Ø12CM KELOMAT

UV1	UV2	IMBALLO
1	2	1/10 PB



9 0 0 2 6 5 5 0 1 5 2 4 9



ART	BARCODE	ST.	PREZZO
01 33 16	4005643983167		34,50

PENTOLA PER BAGNOMARIA INOX 18/8 INDUZIONE 16CM -1,5L GSW

UV1	UV2	IMBALLO
1	3	1/12 PB



4 0 0 5 6 4 3 9 8 3 1 6 7



ART	BARCODE	ST.	PREZZO
01 32 31	4004094314971		9,95

CASSERUOLA 1 MANICO BAGNOMARIA INOX 11CM WESTMARK

UV1	UV2	IMBALLO
1	4	1/4/48 SL



4 0 0 4 0 9 4 3 1 4 9 7 1



ART	BARCODE	ST.	PREZZO
01 12 88	4005643975247		31,50

PADELLA INDUZIONE 'LECHEF' INOX 18/10 INDUZIONE Ø24CM GSW

UV1	UV2	IMBALLO
1	3	1/6 SL



4 0 0 5 6 4 3 9 7 5 2 4 7



ART	BARCODE	ST.	PREZZO
01 12 89	4005643975285		41,00

PADELLA INDUZIONE 'LECHEF' INOX 18/10 INDUZIONE 28CM GSW

UV1	UV2	IMBALLO
1	3	1/6 SL



4 0 0 5 6 4 3 9 7 5 2 8 5



ART	BARCODE	ST.	PREZZO
01 12 90	4005643975322		51,00

PADELLA INDUZIONE 'LECHEF' INOX 18/10 INDUZIONE 32CM GSW

UV1	UV2	IMBALLO
1	3	1/6 SL



4 0 0 5 6 4 3 9 7 5 3 2 2



ART	BARCODE	ST.	PREZZO
01 12 55	4005643166676	A	22,50

PADELLA ANTIADERENTE MANICO INOSSIDABILE INDUZIONE 20CM GSW

UV1	UV2	IMBALLO
1	3	1/6 SL



4 0 0 5 6 4 3 1 6 6 6 7 6



ART	BARCODE	ST.	PREZZO
01 12 56	4005643166683	A	28,50

PADELLA ANTIADERENTE MANICO INOSSIDABILE INDUZIONE 24CM GSW

UV1	UV2	IMBALLO
1	3	1/6 SL



4 0 0 5 6 4 3 1 6 6 6 8 3



ART	BARCODE	ST.	PREZZO
01 12 57	4005643166690	A	34,50

**PADELLA ANTIADERENTE MANICO
INOSSIDABILE INDUZIONE 28CM GSW**

UV1	UV2	IMBALLO
1	3	1/6 SL



4 0 0 5 6 4 3 1 6 6 6 9 0



ART	BARCODE	ST.	PREZZO
01 12 67	4005643868402	A	87,50

**PADELLA WOK+MANICO+COPERCHIO
ANTIADERENTE INDUZ 32CM GSW**

UV1	UV2	IMBALLO
1	2	1/4 PB



4 0 0 5 6 4 3 8 6 8 4 0 2



ART	BARCODE	ST.	PREZZO
01 12 01	4005643390668		16,50

**PADELLA 'TEMPTURA PLUS'
ANTIADERENTE INDUZIONE 20CM GSW**

UV1	UV2	IMBALLO
1	6	1/6 SL



4 0 0 5 6 4 3 3 9 0 6 6 8



ART	BARCODE	ST.	PREZZO
01 12 02	4005643390675		22,50

**PADELLA 'TEMPTURA PLUS'
ANTIADERENTE INDUZIONE 24CM GSW**

UV1	UV2	IMBALLO
1	6	1/6 SL



4 0 0 5 6 4 3 3 9 0 6 7 5



ART	BARCODE	ST.	PREZZO
01 12 03	4005643390682		26,00

**PADELLA 'TEMPTURA PLUS'
ANTIADERENTE INDUZIONE 28CM GSW**

UV1	UV2	IMBALLO
1	6	1/6 SL



4 0 0 5 6 4 3 3 9 0 6 8 2



ART	BARCODE	ST.	PREZZO
01 12 04	4005643390699		31,00

**PADELLA 'TEMPTURA PLUS'
ANTIADERENTE INDUZIONE 32CM GSW**

UV1	UV2	IMBALLO
1	6	1/6 SL



4 0 0 5 6 4 3 3 9 0 6 9 9



ART	BARCODE	ST.	PREZZO
01 13 48	9002655014099		29,50

**PADELLA ANTIADERENTE 'HOT'
INDUZIONE 24 CM KELOMAT**

UV1	UV2	IMBALLO
1	3	1/6 SL



9 0 0 2 6 5 5 0 1 4 0 9 9



ART	BARCODE	ST.	PREZZO
01 13 49	9002655014105		35,00

**PADELLA ANTIADERENTE 'HOT'
INDUZIONE 28 CM KELOMAT**

UV1	UV2	IMBALLO
1	3	1/6 SL



9 0 0 2 6 5 5 0 1 4 1 0 5



ART	BARCODE	ST.	PREZZO
01 36 11	4005643456722		19,90

**PADELLA CREPES ALLUMINIO
ANTIADERENTE INDUZIONE 26CM GSW**

UV1	UV2	IMBALLO
1	6	1/6 SP



4 0 0 5 6 4 3 4 5 6 7 2 2



ART	BARCODE	ST.	PREZZO
04 03 79	4000270698705		1,60

**SPATOLA PER CREPES LEGNO DI
FAGGIO FSC 20X12CM KESPER**

UV1	UV2	IMBALLO
1	20	1/10/200 BK



4 0 0 0 2 7 0 6 9 8 7 0 5



ART	BARCODE	ST.	PREZZO
07 02 93	8004537702934		10,90

**PADELLA WOK ANTIADERENTE
INDUZIONE 20CM EVA**

UV1	UV2	IMBALLO
1	6	1/12 SL



8 0 0 4 5 3 7 7 0 2 9 3 4



ART	BARCODE	ST.	PREZZO
07 02 91	8004537702910		16,80

**WOK/SALTAPASTA
ANTIADERENTE+MANICO BAKELITE
INDUZIO 30CM EVA**

UV1	UV2	IMBALLO
1	6	1/6 SL



8 0 0 4 5 3 7 7 0 2 9 1 0



ART	BARCODE	ST.	PREZZO
07 03 54	8004537703542		39,80

WOK 6 PEZZI GHISA INDUZIONE 30CM EVA

UV1	UV2	IMBALLO
1	2	1/2 PB



8 0 0 4 5 3 7 7 0 3 5 4 2



ART	BARCODE	ST.	PREZZO
07 03 55	8004537703559		49,60

WOK 6 PEZZI GHISA 36CM EVA

UV1	UV2	IMBALLO
1	2	1/2 PB



8 0 0 4 5 3 7 7 0 3 5 5 9



ART	BARCODE	ST.	PREZZO
01 12 84	4005643860956		42,50

WOK/PADELLA MULTIUSO GHISA ANTIADERENTE INDUZIONE 32 CM GSW

UV1	UV2	IMBALLO
1	2	1/2 PB



4 0 0 5 6 4 3 8 6 0 9 5 6



ART	BARCODE	ST.	PREZZO
01 12 83	4005643860963		24,50

PADELLA WOK+MANICO GHISA INDUZIONE 'MULTI' 28CM GSW

UV1	UV2	IMBALLO
1	6	1/6 SL



4 0 0 5 6 4 3 8 6 0 9 6 3



ART	BARCODE	ST.	PREZZO
01 36 58	8004537136586		18,50

BISTECCHIERA ALLUMINIO PRESSOFUSO ANTIAD INDUZ 28X28CM EVA

UV1	UV2	IMBALLO
1	10	1/10 SL



8 0 0 4 5 3 7 1 3 6 5 8 6



ART	BARCODE	ST.	PREZZO
01 81 03	4005643170383	A	9,90

BISTECCHIERA "GOURMET" 28X28CM GSW

UV1	UV2	IMBALLO
1	6	1/6 SL



4 0 0 5 6 4 3 1 7 0 3 8 3



ART	BARCODE	ST.	PREZZO
01 36 59	8004537136593		22,50

BISTECCHIERA ALLUMINIO PRESSOFUSO ANTIAD INDUZ 35X29CM EVA

UV1	UV2	IMBALLO
1	8	1/8 SL



8 0 0 4 5 3 7 1 3 6 5 9 3



ART	BARCODE	ST.	PREZZO
01 36 63	8004537136630		28,50

GRIGLIA ALLUMINIO PRESSOFUSO ANTIAD INDUZIONE 42X27CM EVA

UV1	UV2	IMBALLO
1	6	1/6 PB



8 0 0 4 5 3 7 1 3 6 6 3 0



ART	BARCODE	ST.	PREZZO
01 36 39	9003064230049		27,50

TEGAME 2 MANICI IN FERRO INDUZIONE 20 CM RISS

UV1	UV2	IMBALLO
1	2	1/1 BK



9 0 0 3 0 6 4 2 3 0 0 4 9



ART	BARCODE	ST.	PREZZO
01 30 84	4005643860925		29,50

PADELLA CREPES LIONESE ALLUMINIO INDUZIONE 'GASTRO' 26CM GSW

UV1	UV2	IMBALLO
1	6	1/6 SL



4 0 0 5 6 4 3 8 6 0 9 2 5



ART	BARCODE	ST.	PREZZO
01 36 85	4005643860512		23,50

PADELLA FERRO LIONESE INDUZIONE 'GASTRO' Ø28CM GSW

UV1	UV2	IMBALLO
1	6	1/6 SL



4 0 0 5 6 4 3 8 6 0 5 1 2



ART	BARCODE	ST.	PREZZO
01 36 86	4005643860529		29,50

PADELLA FERRO LIONESE INDUZIONE 'GASTRO' Ø32CM GSW

UV1	UV2	IMBALLO
1	4	1/4 SL



4 0 0 5 6 4 3 8 6 0 5 2 9



ART	BARCODE	ST.	PREZZO
01 36 87	4005643860536		42,50

PADELLA FERRO LIONESE INDUZIONE 'GASTRO' Ø36CM GSW

UV1	UV2	IMBALLO
1	4	1/4 SL



4 0 0 5 6 4 3 8 6 0 5 3 6



ART	BARCODE	ST.	PREZZO
01 36 90	4005643860611		34,50

PADELLA PER PAELLA IN FERRO 'GASTRO' INDUZIONE 34CM GSW

UV1	UV2	IMBALLO
1	3	1/6 SL



4 0 0 5 6 4 3 8 6 0 6 1 1



ART	BARCODE	ST.	PREZZO
01 36 91	4005643860628		43,00

PADELLA PER PAELLA IN FERRO 'GASTRO' INDUZIONE 40CM GSW

UV1	UV2	IMBALLO
1	3	1/6 SL



4 0 0 5 6 4 3 8 6 0 6 2 8



ART	BARCODE	ST.	PREZZO
01 36 41	9003064230056	A	29,50

PADELLA TIROLESE IN FERRO INDUZIONE 16 CM RIESS

UV1	UV2	IMBALLO
1	2	1/1 BK



9 0 0 3 0 6 4 2 3 0 0 5 6



ART	BARCODE	ST.	PREZZO
01 36 42	9003064230063		36,00

PADELLA TIROLESE IN FERRO INDUZIONE 20 CM RIESS

UV1	UV2	IMBALLO
1	2	1/1 BK



9 0 0 3 0 6 4 2 3 0 0 6 3



ART	BARCODE	ST.	PREZZO
01 36 43	9003064230070		42,50

PADELLA TIROLESE IN FERRO INDUZIONE 24 CM RIESS

UV1	UV2	IMBALLO
1	2	1/1 BK



9 0 0 3 0 6 4 2 3 0 0 7 0



ART	BARCODE	ST.	PREZZO
01 36 44	9003064230087		51,00

PADELLA TIROLESE IN FERRO INDUZIONE 28 CM RIESS

UV1	UV2	IMBALLO
1	2	1/1 BK



9 0 0 3 0 6 4 2 3 0 0 8 7



ART	BARCODE	ST.	PREZZO
01 36 45	9003064230094		61,50

PADELLA TIROLESE IN FERRO+CONTROMANICO INDUZIONE 32 CM RIESS

UV1	UV2	IMBALLO
1	2	1/1 BK



9 0 0 3 0 6 4 2 3 0 0 9 4



ART	BARCODE	ST.	PREZZO
01 36 46	9003064230100		79,50

PADELLA TIROLESE IN FERRO+CONTROMANICO INDUZIONE 40 CM RIESS

UV1	UV2	IMBALLO
1	2	1/1 BK



9 0 0 3 0 6 4 2 3 0 1 0 0



ART	BARCODE	ST.	PREZZO
11 06 02	8010874070261		5,30

PADELLA CASTAGNE FERRO 27CM

UV1	UV2	IMBALLO
1	5	1/30 SL



8 0 1 0 8 7 4 0 7 0 2 6 1



ART	BARCODE	ST.	PREZZO
11 06 06	9003064220804	A	75,00

PADELLA CASTAGNE FERRO CON CONTRO-MANICO 32CM RIESS

UV1	UV2	IMBALLO
1	2	1/1 BK



9 0 0 3 0 6 4 2 2 0 8 0 4



ART	BARCODE	ST.	PREZZO
11 06 05	8010874070308		6,35

PADELLA CASTAGNE FERRO 30CM

UV1	UV2	IMBALLO
1	5	1/30 SL



8 0 1 0 8 7 4 0 7 0 3 0 8



ART	BARCODE	ST.	PREZZO
01 31 81	4005643801126	A	8,50

**CASSERUOLA MINI+COPERCHIO INOX
INDUZIONE 12CM GSW**

UV1	UV2	IMBALLO
1	6	1/12 SP



4 0 0 5 6 4 3 8 0 1 1 2 6



ART	BARCODE	ST.	PREZZO
01 31 82	4005643801140	A	9,50

**CASSERUOLA MINI+COPERCHIO INOX
INDUZIONE 14CM GSW**

UV1	UV2	IMBALLO
1	6	1/12 SP



4 0 0 5 6 4 3 8 0 1 1 4 0



ART	BARCODE	ST.	PREZZO
01 31 84	4005643990226		12,50

**PENTOLA MINI+COPERCHIO MONTREAL
INOX INDUZIONE 12CM GSW**

UV1	UV2	IMBALLO
1	6	1/12 SP



4 0 0 5 6 4 3 9 9 0 2 2 6



ART	BARCODE	ST.	PREZZO
01 31 85	4005643990158		14,50

**PENTOLA MINI+COPERCHIO MONTREAL
INOX INDUZIONE 14CM GSW**

UV1	UV2	IMBALLO
1	6	1/12 SP



4 0 0 5 6 4 3 9 9 0 1 5 8



ART	BARCODE	ST.	PREZZO
01 12 60	4005643409414	A	19,50

**SET 2 PADELLE ALLUMINIO 'BASIC LINE'
Ø 24+28 CM GSW**

UV1	UV2	IMBALLO
1	4	1/4 SP



4 0 0 5 6 4 3 4 0 9 4 1 4



ART	BARCODE	ST.	PREZZO
01 06 01	8010874103662		69,50

**PAIOLO CON MANICO AD ARCO IN RAME
MARTELLATO 26 CM**

UV1	UV2	IMBALLO
1	2	1/10 AL



8 0 1 0 8 7 4 1 0 3 6 6 2



ART	BARCODE	ST.	PREZZO
01 06 02	8010874103556		69,50

**PAIOLO CON MANICO DI LEGNO IN RAME
MARTELLATO 26 CM**

UV1	UV2	IMBALLO
1	2	1/10 AL



8 0 1 0 8 7 4 1 0 3 5 5 6



ART	BARCODE	ST.	PREZZO
01 06 03	8010874010380		92,50

**PAIOLO CON 2 MANICI IN RAME
MARTELLATO PER INDUZIONE 26 CM**

UV1	UV2	IMBALLO
1	2	1/6 AL



8 0 1 0 8 7 4 0 1 0 3 8 0



ART	BARCODE	ST.	PREZZO
01 06 04	8010874010540		175,00

**PAIOLO CON 2 MANICI IN RAME
MARTELLATO CON MOTORE 8W 26 CM**

UV1	UV2	IMBALLO
1	2	1/4 PB



8 0 1 0 8 7 4 0 1 0 5 4 0



ART	BARCODE	ST.	PREZZO
01 30 85	4005643860949		59,50

**ROSTIERA ALU FERROTHERM 'GASTRO'
41X28X14CM-6,5L GSW**

UV1	UV2	IMBALLO
1	4	1/4 SL



4 0 0 5 6 4 3 8 6 0 9 4 9



ART	BARCODE	ST.	PREZZO
01 30 86	4005643860932		67,50

**ROSTIERA ALU FERROTHERM 'GASTRO'
44X31X14CM-8,0L GSW**

UV1	UV2	IMBALLO
1	4	1/4 SL



4 0 0 5 6 4 3 8 6 0 9 3 2



ART	BARCODE	ST.	PREZZO
01 35 20	8011126000241		13,80

**ROSTIERA ACCIAIO INOSSIDABILE 18/8
25 CM GNALI**

UV1	UV2	IMBALLO
1	4	1/12 AL



8 0 1 1 1 2 6 0 0 0 2 4 1



ART	BARCODE	ST.	PREZZO
01 35 21	8011126000234		15,40

ROSTIERA ACCIAIO INOSSIDABILE 18/8
30 CM GNALI

UV1	UV2	IMBALLO
1	6	1/12 AL



8 0 1 1 1 2 6 0 0 0 2 3 4



ART	BARCODE	ST.	PREZZO
01 35 22	8011126000227		17,30

ROSTIERA ACCIAIO INOSSIDABILE 18/8
35CM GNALI

UV1	UV2	IMBALLO
1	5	1/12 AL



8 0 1 1 1 2 6 0 0 0 2 2 7



ART	BARCODE	ST.	PREZZO
01 35 23	8011126000204		19,60

ROSTIERA ACCIAIO INOSSIDABILE 18/8
40CM GNALI

UV1	UV2	IMBALLO
1	3	1/6 AL



8 0 1 1 1 2 6 0 0 0 2 0 4



ART	BARCODE	ST.	PREZZO
01 35 26	4005643889148	A	42,50

ROSTIERA ACCIAIO INOX 18/10 37X25CM
GSW

UV1	UV2	IMBALLO
1	2	1/1 BK



4 0 0 5 6 4 3 8 8 9 1 4 8



ART	BARCODE	ST.	PREZZO
01 35 27	8009463382250		15,90

ROSTIERA ACCIAIO INOX 18/10
'FORNOMANIA' 25X18X5,5CM FRABOSK

UV1	UV2	IMBALLO
1	3	1/12 CL



8 0 0 9 4 6 3 3 8 2 2 5 0



ART	BARCODE	ST.	PREZZO
01 35 28	8009463382304		18,50

ROSTIERA ACCIAIO INOX 18/10
'FORNOMANIA' 30X22X6.5CM FRABOSK

UV1	UV2	IMBALLO
1	3	1/12 CL



8 0 0 9 4 6 3 3 8 2 3 0 4



ART	BARCODE	ST.	PREZZO
01 35 29	8009463382359		21,50

ROSTIERA ACCIAIO INOX 18/10
'FORNOMANIA' 35X26X7.5CM FRABOSK

UV1	UV2	IMBALLO
1	3	1/6 CL



8 0 0 9 4 6 3 3 8 2 3 5 9



ART	BARCODE	ST.	PREZZO
01 12 82	4005643410694		63,50

ROSTIERA+COPERCHIO AROMA
'GOURMET' 40x26x11 CM GSW

UV1	UV2	IMBALLO
1	2	1/2 PB



4 0 0 5 6 4 3 4 1 0 6 9 4



ART	BARCODE	ST.	PREZZO
01 12 85	4005643410182		55,00

ROSTIERA+COPERCHIO AROMA
'GOURMET' INDUZIONE 33x21x11 CM
GSW

UV1	UV2	IMBALLO
1	2	1/4 PB



4 0 0 5 6 4 3 4 1 0 1 8 2



ART	BARCODE	ST.	PREZZO
01 12 87	4005643414593	A	42,50

ROSTIERA+COPERCHIO
AROMA+CESTELLO INDUZIONE 39x25x9.5
CM GSW

UV1	UV2	IMBALLO
1	2	1/2 PB



4 0 0 5 6 4 3 4 1 4 5 9 3



ART	BARCODE	ST.	PREZZO
01 37 10	8004537137101		21,00

BOLLITORE 'MELODY' ACCIAIO
INOSSIDABILE MISURA 3.0 EVA

UV1	UV2	IMBALLO
1	6	1/12 PB



8 0 0 4 5 3 7 1 3 7 1 0 1



ART	BARCODE	ST.	PREZZO
01 37 11	8004537137118		23,50

BOLLITORE 'MELODY' ACCIAIO
INOSSIDABILE MISURA 4.0 EVA

UV1	UV2	IMBALLO
1	6	1/12 PB



8 0 0 4 5 3 7 1 3 7 1 1 8



ART	BARCODE	ST.	PREZZO
01 37 12	8004537137125		27,00

BOLLITORE 'MELODY' ACCIAIO INOSSIDABILE MISURA 5.0 EVA

UV1	UV2	IMBALLO
1	6	1/12 PB



8 0 0 4 5 3 7 1 3 7 1 2 5



ART	BARCODE	ST.	PREZZO
01 37 07	8004537137071		9,75

BOLLITORE+FISCHIO INDUZIONE INOX 1,0 L EVA

UV1	UV2	IMBALLO
1	6	1/12 PB



8 0 0 4 5 3 7 1 3 7 0 7 1



ART	BARCODE	ST.	PREZZO
01 37 60	8004537137606		10,80

BOLLITORE+FISCHIO ACCIAIO INOSSIDABILE INDUZIONE 1,5L EVA

UV1	UV2	IMBALLO
1	6	1/12 PB



8 0 0 4 5 3 7 1 3 7 6 0 6



ART	BARCODE	ST.	PREZZO
01 37 61	8004537137613		13,40

BOLLITORE+FISCHIO ACCIAIO INOSSIDABILE INDUZIONE 2,3L EVA

UV1	UV2	IMBALLO
1	6	1/12 PB



8 0 0 4 5 3 7 1 3 7 6 1 3



ART	BARCODE	ST.	PREZZO
01 37 15	8004537137156	H	16,90

BOLLITORE ACCIAIO INOSSIDABILE MISURA 3.0 EVA

UV1	UV2	IMBALLO
1	12	1/24 PB



8 0 0 4 5 3 7 1 3 7 1 5 6



ART	BARCODE	ST.	PREZZO
01 37 14	8004537137149	H	19,90

BOLLITORE ACCIAIO INOSSIDABILE MISURA 4.0 EVA

UV1	UV2	IMBALLO
1	12	1/12 PB



8 0 0 4 5 3 7 1 3 7 1 4 9



ART	BARCODE	ST.	PREZZO
01 37 59	8004537137590		16,90

BOLLITORE+FISCHIO FONDO INCAPSULATO INOX INDUZIONE 2L EVA

UV1	UV2	IMBALLO
1	6	1/12 PB



8 0 0 4 5 3 7 1 3 7 5 9 0



ART	BARCODE	ST.	PREZZO
01 37 69	8004537137699	A	16,50

BOLLITORE+FISCHIO INOX INDUZIONE 2,5L EVA

UV1	UV2	IMBALLO
1	6	1/12 PB



8 0 0 4 5 3 7 1 3 7 6 9 9



ART	BARCODE	ST.	PREZZO
01 37 70	8004537137705		14,50

BOLLITORE+FISCHIO BIANCO PUNTINI ROSSI INDUZIONE 1,5L EVA

UV1	UV2	IMBALLO
1	6	1/12 PB



8 0 0 4 5 3 7 1 3 7 7 0 5



ART	BARCODE	ST.	PREZZO
01 37 71	8004537137712		12,90

BOLLITORE+FISCHIO NERO SATINATO INDUZIONE 1,5L EVA

UV1	UV2	IMBALLO
1	6	1/12 PB



8 0 0 4 5 3 7 1 3 7 7 1 2



ART	BARCODE	ST.	PREZZO
01 37 62	8004537137620		16,40

BOLLITORE+FISCHIO NERO/MANICO LEGNO INDUZIONE 2,5L EVA

UV1	UV2	IMBALLO
1	6	1/12 PB



8 0 0 4 5 3 7 1 3 7 6 2 0



ART	BARCODE	ST.	PREZZO
01 37 72	8004537137729		11,50

BOLLITORE+FISCHIO INOX/MANICO LEGNO INDUZIONE 1,5L EVA

UV1	UV2	IMBALLO
1	6	1/12 PB



8 0 0 4 5 3 7 1 3 7 7 2 9



ART	BARCODE	ST.	PREZZO
01 37 73	8004537137736		14,70

BOLLITORE+FISCHIO INOX/MANICO LEGNO INDUZIONE 2,5L EVA

UV1	UV2	IMBALLO
1	6	1/12 PB



8 0 0 4 5 3 7 1 3 7 7 3 6



ART	BARCODE	ST.	PREZZO
01 37 56	4005643253314	A	14,90

BOLLITORE SMALTO FLORA INDUZIONE 2L GSW

UV1	UV2	IMBALLO
1	6	1/12 BX



4 0 0 5 6 4 3 2 5 3 3 1 4



ART	BARCODE	ST.	PREZZO
01 37 55	4005643299282	A	9,95

BOLLITORE SMALTO 'LIANE' INDUZIONE 2L GSW

UV1	UV2	IMBALLO
1	6	1/12 BX



4 0 0 5 6 4 3 2 9 9 2 8 2



ART	BARCODE	ST.	PREZZO
01 37 48	8004537137484		11,90

BOLLITORE+FISCHIO ACCIAIO INOX COLORI ASSORTITI 1,5L EVA

UV1	UV2	IMBALLO
1	6	1/12 PB



8 0 0 4 5 3 7 1 3 7 4 8 4



ART	BARCODE	ST.	PREZZO
01 37 49	8004537137491		13,20

BOLLITORE+FISCHIO ACCIAIO INOX COLORI ASSORTITI 2,0L EVA

UV1	UV2	IMBALLO
1	6	1/12 PB



8 0 0 4 5 3 7 1 3 7 4 9 1



ART	BARCODE	ST.	PREZZO
01 37 03	8004537137033		11,50

BOLLACQUA SMALTO ASSORTITO INDUZIONE 1,0 L EVA

UV1	UV2	IMBALLO
1	6	1/6/24 PB



8 0 0 4 5 3 7 1 3 7 0 3 3

Friggere Cottura a vapore



ART	BARCODE	ST.	PREZZO
01 27 01	8593419414688		9,75

PIROFILA+COPERCHIO ROTONDA VETRO
1L Ø18CM SIMAX

UV1	UV2	IMBALLO
1	12	1/12 SL



8 5 9 3 4 1 9 4 1 4 6 8 8



ART	BARCODE	ST.	PREZZO
01 27 02	8593419414589		10,70

PIROFILA+COPERCHIO ROTONDA VETRO
1,5L Ø20CM SIMAX

UV1	UV2	IMBALLO
1	10	1/10 SL



8 5 9 3 4 1 9 4 1 4 5 8 9



ART	BARCODE	ST.	PREZZO
01 27 03	8593419414565		13,50

PIROFILA+COPERCHIO ROTONDA VETRO
2L Ø23CM SIMAX

UV1	UV2	IMBALLO
1	8	1/8 SL



8 5 9 3 4 1 9 4 1 4 5 6 5



ART	BARCODE	ST.	PREZZO
01 27 04	8593419414602		15,75

PIROFILA+COPERCHIO ROTONDA VETRO
2,5L Ø25CM SIMAX

UV1	UV2	IMBALLO
1	6	1/6 SL



8 5 9 3 4 1 9 4 1 4 6 0 2



ART	BARCODE	ST.	PREZZO
01 27 05	8593419414749		19,90

PIROFILA+COPERCHIO RETTANGOLARE
VETRO 2,8L 5X20X13CM SIMAX

UV1	UV2	IMBALLO
1	4	1/4 SL



8 5 9 3 4 1 9 4 1 4 7 4 9



ART	BARCODE	ST.	PREZZO
01 27 06	8593419414640		15,90

PIROFILA+COPERCHIO OVALE VETRO
2,4L 33X20X11CM SIMAX

UV1	UV2	IMBALLO
1	4	1/4 SL



8 5 9 3 4 1 9 4 1 4 6 4 0



ART	BARCODE	ST.	PREZZO
01 27 96	8593419414466		33,60

ROSTIERA OVALE + COPERCHIO VETRO
8L 41X26X16CM SIMAX

UV1	UV2	IMBALLO
1	3	1/3 SL



8 5 9 3 4 1 9 4 1 4 4 6 6



ART	BARCODE	ST.	PREZZO
01 27 08	8593419205026		9,40

CONTENITORE+COPERCHIO VETRO 0,5L
15X15X4,5CM SIMAX

UV1	UV2	IMBALLO
1	6	1/6 AL



8 5 9 3 4 1 9 2 0 5 0 2 6



ART	BARCODE	ST.	PREZZO
01 27 09	8593419204999		11,00

CONTENITORE+COPERCHIO VETRO 1L
18X18X5,5 CM SIMAX

UV1	UV2	IMBALLO
1	6	1/6 AL



8 5 9 3 4 1 9 2 0 4 9 9 9



ART	BARCODE	ST.	PREZZO
01 27 10	8593419204975		12,55

CONTENITORE+COPERCHIO VETRO 1,7L
21X21X6,5CM SIMAX

UV1	UV2	IMBALLO
1	6	1/6 AL



8 5 9 3 4 1 9 2 0 4 9 7 5



ART	BARCODE	ST.	PREZZO
01 27 81	8593419414442		9,95

PIROFILA RETTANGOLARE VETRO 1,6L
25X21X5,5CM SIMAX

UV1	UV2	IMBALLO
1	6	1/6 CL



8 5 9 3 4 1 9 4 1 4 4 4 2



ART	BARCODE	ST.	PREZZO
01 27 82	8593419414428		9,95

PIROFILA RETTANGOLARE VETRO 1,5L
31X17X5CM SIMAX

UV1	UV2	IMBALLO
1	11	1/11 CL



8 5 9 3 4 1 9 4 1 4 4 2 8



ART	BARCODE	ST.	PREZZO
01 27 89	8593419414404		11,00

**PIROFILA RETTANGOLARE VETRO 2,4L
35X19X5CM SIMAX**

UV1	UV2	IMBALLO
1	11	1/11 CL



8 5 9 3 4 1 9 4 1 4 4 0 4



ART	BARCODE	ST.	PREZZO
01 27 83	8593419414381		13,90

**PIROFILA RETTANGOLARE VETRO 3L
38X22X6CM SIMAX**

UV1	UV2	IMBALLO
1	4	1/4 CL



8 5 9 3 4 1 9 4 1 4 3 8 1



ART	BARCODE	ST.	PREZZO
01 27 85	8593419484018		17,10

**PIROFILA RETTANGOLARE VETRO 4,8L
42X28X5,5CM SIMAX**

UV1	UV2	IMBALLO
1	3	1/3 CL



8 5 9 3 4 1 9 4 8 4 0 1 8



ART	BARCODE	ST.	PREZZO
01 27 86	8593419415661		6,85

**CIOTOLA PER IMPASTARE VETRO 1,3L
Ø18CM SIMAX**

UV1	UV2	IMBALLO
1	12	1/12 AL



8 5 9 3 4 1 9 4 1 5 6 6 1



ART	BARCODE	ST.	PREZZO
01 27 87	8593419415708		9,00

**CIOTOLA PER IMPASTARE VETRO 2,5L
Ø22CM SIMAX**

UV1	UV2	IMBALLO
1	4	1/4 AL



8 5 9 3 4 1 9 4 1 5 7 0 8



ART	BARCODE	ST.	PREZZO
01 27 88	8593419415722		11,70

**CIOTOLA PER IMPASTARE VETRO 3,5L
Ø26CM SIMAX**

UV1	UV2	IMBALLO
1	4	1/4 AL



8 5 9 3 4 1 9 4 1 5 7 2 2



ART	BARCODE	ST.	PREZZO
01 27 99	4000753151222	A	19,50

**PIROFILE VETRO SET 5 PEZZI BOHEMIA
CRISTAL**

UV1	UV2	IMBALLO
1	2	1/2 PB



4 0 0 0 7 5 3 1 5 1 2 2 2



ART	BARCODE	ST.	PREZZO
07 09 83	8004537709834		27,90

**CUOCIVAPORE BAMBU "DIM SUM
L"25,5CM EVA**

UV1	UV2	IMBALLO
1	6	1/12 SP



8 0 0 4 5 3 7 7 0 9 8 3 4



ART	BARCODE	ST.	PREZZO
07 09 84	8004537709841		21,90

**CUOCIVAPORE 'DIM SUM' BAMBU 18CM
EVA**

UV1	UV2	IMBALLO
1	6	1/18 SP



8 0 0 4 5 3 7 7 0 9 8 4 1



ART	BARCODE	ST.	PREZZO
01 39 05	8010874030647		40,00

**PENTOLA FRIGGITRICE FERRO
INDUZIONE 34CM**

UV1	UV2	IMBALLO
1	3	1/1 CL



8 0 1 0 8 7 4 0 3 0 6 4 7



ART	BARCODE	ST.	PREZZO
01 39 06	8010874030654		45,00

**PENTOLA FRIGGITRICE FERRO
INDUZIONE 40CM**

UV1	UV2	IMBALLO
1	3	1/1 CL



8 0 1 0 8 7 4 0 3 0 6 5 4



ART	BARCODE	ST.	PREZZO
01 39 07	8010874030661		63,50

**PENTOLA FRIGGITRICE FERRO
INDUZIONE 46CM**

UV1	UV2	IMBALLO
1	3	1/1 CL



8 0 1 0 8 7 4 0 3 0 6 6 1



ART	BARCODE	ST.	PREZZO
01 39 08	8004537139082		37,50

**CESTELLO PENTOLA FRIGGITRICE
STAGNATO Ø34CM L.A.R.**

UV1	UV2	IMBALLO
1	3	1/1 BK



8 0 0 4 5 3 7 1 3 9 0 8 2



ART	BARCODE	ST.	PREZZO
01 39 09	8004537139099		51,00

**CESTELLO PENTOLA FRIGGITRICE
STAGNATO Ø40CM L.A.R.**

UV1	UV2	IMBALLO
1	3	1/1 BK



8 0 0 4 5 3 7 1 3 9 0 9 9



ART	BARCODE	ST.	PREZZO
01 39 10	8004537139105		72,00

**CESTELLO PENTOLA FRIGGITRICE
STAGNATO Ø46CM L.A.R.**

UV1	UV2	IMBALLO
1	3	1/1 BK



8 0 0 4 5 3 7 1 3 9 1 0 5



ART	BARCODE	ST.	PREZZO
01 39 04	8010874030883		26,00

**PENTOLA FRIGGITRICE INOX CON
CESTELLO STAGNATO 26CM**

UV1	UV2	IMBALLO
1	6	1/6 SP



8 0 1 0 8 7 4 0 3 0 8 8 3



ART	BARCODE	ST.	PREZZO
01 39 20	4005643488204		28,00

**FRIGGITRICE CON COPERCHIO E
CESTELLO INOX INDUZIONE 22CM GSW**

UV1	UV2	IMBALLO
1	4	1/4 SP



4 0 0 5 6 4 3 4 8 8 2 0 4

Linea smalto



ART	BARCODE	ST.	PREZZO
01 21 75	8018833813133		4,10

MUG SMALTATO ROSSO Ø8CM

UV1	UV2	IMBALLO
1	12	1/12 BK



8 0 1 8 8 3 3 8 1 3 1 3 3



ART	BARCODE	ST.	PREZZO
01 21 76	8018833813140		4,45

MUG SMALTATO ROSSO Ø9CM

UV1	UV2	IMBALLO
1	12	1/12 BK



8 0 1 8 8 3 3 8 1 3 1 4 0



ART	BARCODE	ST.	PREZZO
01 21 42	8018833813164		6,20

PIGNATTA SMALTATO ROSSO Ø10CM

UV1	UV2	IMBALLO
1	12	1/12 BK



8 0 1 8 8 3 3 8 1 3 1 6 4



ART	BARCODE	ST.	PREZZO
01 21 43	8018833813171		7,30

PIGNATTA SMALTATO ROSSO Ø12CM

UV1	UV2	IMBALLO
1	12	1/12 BK



8 0 1 8 8 3 3 8 1 3 1 7 1



ART	BARCODE	ST.	PREZZO
01 21 44	8018833813188		8,75

PIGNATTA SMALTATO ROSSO Ø14CM

UV1	UV2	IMBALLO
1	12	1/12 BK



8 0 1 8 8 3 3 8 1 3 1 8 8



ART	BARCODE	ST.	PREZZO
01 21 72	8018833813102		3,50

TAZZINA CAFFE' SMALTATO ROSSO 5CM

UV1	UV2	IMBALLO
6	12	1/6/180 BK



8 0 1 8 8 3 3 8 1 3 1 0 2



ART	BARCODE	ST.	PREZZO
01 21 73	8018833813119		5,80

TAZZINA CAFFE' CON PIATTINO SMALTATO ROSSO 5CM

UV1	UV2	IMBALLO
6	12	1/6/144 BK



8 0 1 8 8 3 3 8 1 3 1 1 9



ART	BARCODE	ST.	PREZZO
01 21 70	8018833872307	A	6,50

BICCHIERINO CONICO CAFFE' SMALTATO ROSSO 10CL

UV1	UV2	IMBALLO
1	6	1/36 BK



8 0 1 8 8 3 3 8 7 2 3 0 7



ART	BARCODE	ST.	PREZZO
01 21 71	8018833872314	A	7,30

BICCHIERE CONICO CAFFE' SMALTATO ROSSO 30CL

UV1	UV2	IMBALLO
1	6	1/36 BK



8 0 1 8 8 3 3 8 7 2 3 1 4



ART	BARCODE	ST.	PREZZO
01 21 37	8018833812358	A	4,90

CASSERUOLA 1 MANICO SMALTATO ROSSO INDUZIONE Ø12CM

UV1	UV2	IMBALLO
1	12	1/12 BK



8 0 1 8 8 3 3 8 1 2 3 5 8



ART	BARCODE	ST.	PREZZO
01 21 38	8018833812365	A	5,50

CASSERUOLA 1 MANICO SMALTATO ROSSO INDUZIONE Ø14CM

UV1	UV2	IMBALLO
1	12	1/12 BK



8 0 1 8 8 3 3 8 1 2 3 6 5



ART	BARCODE	ST.	PREZZO
01 21 34	8018833813348		13,80

3 CASSERUOLE BASSE SMALTATO ROSSO INDUZIONE 12/14/16CM

UV1	UV2	IMBALLO
1	6	1/6 SP



8 0 1 8 8 3 3 8 1 3 3 4 8



ART	BARCODE	ST.	PREZZO
01 21 35	8018833813591		16,80

3 CASSERUOLE FONDE SMALTATO ROSSO INDUZIONE 14/16/18CM

UV1	UV2	IMBALLO
1	6	1/6 SP



8 0 1 8 8 3 3 8 1 3 5 9 1



ART	BARCODE	ST.	PREZZO
01 39 25	8018833813966		16,90

PENTOLA PER FRIGGERE+CESTELLO SMALTO ROSSO INDUZIONE 24CM

UV1	UV2	IMBALLO
1	4	1/4 BK



8 0 1 8 8 3 3 8 1 3 9 6 6



ART	BARCODE	ST.	PREZZO
01 21 51	8018833813058	H	6,95

COGOMA CAFFE' TURCO SMALTATO ROSSO NR. 5

UV1	UV2	IMBALLO
1	6	1/6 BK



8 0 1 8 8 3 3 8 1 3 0 5 8



ART	BARCODE	ST.	PREZZO
01 21 53	8018833812976		8,75

CAFFETTIERA SMALTATO ROSSO Ø8CM

UV1	UV2	IMBALLO
1	6	1/12 BK



8 0 1 8 8 3 3 8 1 2 9 7 6



ART	BARCODE	ST.	PREZZO
01 21 55	8018833812983		13,10

CAFFETTIERA SMALTATO ROSSO 0,6L Ø11CM

UV1	UV2	IMBALLO
1	6	1/12 BK



8 0 1 8 8 3 3 8 1 2 9 8 3



ART	BARCODE	ST.	PREZZO
01 21 62	8018833812952		15,95

TEIERA SMALTATO ROSSO 0,7L Ø12CM

UV1	UV2	IMBALLO
1	6	1/6 BK



8 0 1 8 8 3 3 8 1 2 9 5 2



ART	BARCODE	ST.	PREZZO
01 21 66	8018833812914	A	20,90

BOLLITORE SMALTATO ROSSO 1,0L INDUZIONE 16CM

UV1	UV2	IMBALLO
1	6	1/12 BK



8 0 1 8 8 3 3 8 1 2 9 1 4



ART	BARCODE	ST.	PREZZO
01 22 38	8018833831137		4,75

MUG SMALTATO CUORE Ø8CM

UV1	UV2	IMBALLO
1	12	1/12 BK



8 0 1 8 8 3 3 8 3 1 1 3 7



ART	BARCODE	ST.	PREZZO
01 22 39	8018833833889		6,10

TAZZA SMALTATO ROSSO/CUORI Ø10CM

UV1	UV2	IMBALLO
1	6	1/18 BK



8 0 1 8 8 3 3 8 3 3 8 8 9



ART	BARCODE	ST.	PREZZO
01 22 21	8018833831168		7,00

PIGNATTA SMALTATO CUORE Ø10CM

UV1	UV2	IMBALLO
1	6	1/24 BK



8 0 1 8 8 3 3 8 3 1 1 6 8



ART	BARCODE	ST.	PREZZO
01 22 22	8018833831175		8,20

PIGNATTA SMALTATO CUORE Ø12CM

UV1	UV2	IMBALLO
1	12	1/12 BK



8 0 1 8 8 3 3 8 3 1 1 7 5



ART	BARCODE	ST.	PREZZO
01 22 40	8018833831403		8,70

SECCHIELLO SMALTATO ROSSO/CUORI Ø14CM

UV1	UV2	IMBALLO
1	6	1/6 BK



8 0 1 8 8 3 3 8 3 1 4 0 3



ART	BARCODE	ST.	PREZZO
01 22 50	8018833817131		4,10

MUG SMALTATO BIANCO/BORDO BLU
Ø8CM

UV1	UV2	IMBALLO
1	12	1/12 BK



8 0 1 8 8 3 3 8 1 7 1 3 1



ART	BARCODE	ST.	PREZZO
01 22 51	8018833813577		5,65

TAZZA SMALTATO BIANCO/ BORDO BLU
Ø10CM

UV1	UV2	IMBALLO
1	6	1/12 BK



8 0 1 8 8 3 3 8 1 3 5 7 7



ART	BARCODE	ST.	PREZZO
01 22 52	8018833817162		6,20

PIGNATTA SMALTATO BIANCO/BLU
Ø10CM

UV1	UV2	IMBALLO
1	12	1/12 BK



8 0 1 8 8 3 3 8 1 7 1 6 2



ART	BARCODE	ST.	PREZZO
01 22 53	8018833817179		7,30

PIGNATTA SMALTATO BIANCO/BLU
INDUZIONE 12CM

UV1	UV2	IMBALLO
1	12	1/12 BK



8 0 1 8 8 3 3 8 1 7 1 7 9



ART	BARCODE	ST.	PREZZO
01 22 54	8018833817186		8,75

PIGNATTA SMALTATO BIANCO/BLU
INDUZIONE 14CM

UV1	UV2	IMBALLO
1	12	1/12 BK



8 0 1 8 8 3 3 8 1 7 1 8 6



ART	BARCODE	ST.	PREZZO
01 22 67	8018833813560		11,60

MISURA GRADUATA SMALTATO
BIANCO/BLU 1,25L Ø10CM

UV1	UV2	IMBALLO
1	12	1/12 BK



8 0 1 8 8 3 3 8 1 3 5 6 0



ART	BARCODE	ST.	PREZZO
01 22 58	8018833813546		5,65

SCODELLA MUESLI SMALTO
BIANCO/BLU 12CM

UV1	UV2	IMBALLO
1	6	1/12 BK



8 0 1 8 8 3 3 8 1 3 5 4 6



ART	BARCODE	ST.	PREZZO
01 22 48	8018833817100		3,50

TAZZINA CAFFE' SMALTATO BIANCO/BLU
5CM

UV1	UV2	IMBALLO
6	12	1/6/180 BK



8 0 1 8 8 3 3 8 1 7 1 0 0



ART	BARCODE	ST.	PREZZO
01 22 49	8018833817117		5,80

TAZZINA CAFFE' CON PIATTINO
SMALTATO BIANCO/BLU 5CM

UV1	UV2	IMBALLO
6	12	1/6/144 BK



8 0 1 8 8 3 3 8 1 7 1 1 7



ART	BARCODE	ST.	PREZZO
01 22 46	8018833872260	A	6,50

BICCHIERINO CONICO CAFFE'
SMALTATO BIANCO/BLU 10CL

UV1	UV2	IMBALLO
1	6	1/36 BK



8 0 1 8 8 3 3 8 7 2 2 6 0



ART	BARCODE	ST.	PREZZO
01 22 47	8018833872277	A	7,30

BICCHIERE CONICO CAFFE' SMALTATO
BIANCO/BLU 30CL

UV1	UV2	IMBALLO
1	6	1/36 BK



8 0 1 8 8 3 3 8 7 2 2 7 7



ART	BARCODE	ST.	PREZZO
01 22 55	8018833813515		5,90

PIATTO FONDO SMALTATO BIANCO/BLU
Ø22CM

UV1	UV2	IMBALLO
1	6	1/6 BK



8 0 1 8 8 3 3 8 1 3 5 1 5



ART	BARCODE	ST.	PREZZO
01 22 57	8018833813539		6,10

PIATTO PIANO SMALTATO BIANCO/BLU Ø25CM

UV1	UV2	IMBALLO
1	6	1/6 BK



8 0 1 8 8 3 3 8 1 3 5 3 9



ART	BARCODE	ST.	PREZZO
01 22 73	8018833813584		16,70

PIATTO DA PORTATA ROTONDO BIANCO/BLU Ø36CM

UV1	UV2	IMBALLO
1	6	1/6 BK



8 0 1 8 8 3 3 8 1 3 5 8 4



ART	BARCODE	ST.	PREZZO
01 22 72	8018833813959		18,10

PIATTO DA PORTATA OVALE SMALTATO BIANCO/BLU 38X28CM

UV1	UV2	IMBALLO
1	6	1/6 BK



8 0 1 8 8 3 3 8 1 3 9 5 9



ART	BARCODE	ST.	PREZZO
01 22 71	8018833813942		15,10

PIATTO DA PORTATA OVALE SMALTATO BIANCO/BLU 35X25CM

UV1	UV2	IMBALLO
1	6	1/6 BK



8 0 1 8 8 3 3 8 1 3 9 4 2



ART	BARCODE	ST.	PREZZO
01 22 68	8018833816523		5,55

TEGAME 2 MANIC SMALTATO BIANCO/BLU Ø14CM

UV1	UV2	IMBALLO
1	12	1/12 BK



8 0 1 8 8 3 3 8 1 6 5 2 3



ART	BARCODE	ST.	PREZZO
01 22 69	8018833816547		6,90

TEGAME 2 MANIC SMALTATO BIANCO/BLU Ø18CM

UV1	UV2	IMBALLO
1	6	1/12 BK



8 0 1 8 8 3 3 8 1 6 5 4 7



ART	BARCODE	ST.	PREZZO
01 22 59	8018833816578		9,00

TEGAME 2 MANICI SMALTATO BIANCO/BLU Ø24CM

UV1	UV2	IMBALLO
1	6	1/6 BK



8 0 1 8 8 3 3 8 1 6 5 7 8



ART	BARCODE	ST.	PREZZO
01 22 61	8018833816592		11,50

TEGAME 2 MANICI SMALTATO BIANCO/BLU Ø28CM

UV1	UV2	IMBALLO
1	6	1/6 BK



8 0 1 8 8 3 3 8 1 6 5 9 2



ART	BARCODE	ST.	PREZZO
01 22 63	8018833816615		14,15

TEGAME 2 MANICI SMALTATO BIANCO/BLU Ø32CM

UV1	UV2	IMBALLO
1	6	1/6 BK



8 0 1 8 8 3 3 8 1 6 6 1 5



ART	BARCODE	ST.	PREZZO
04 02 11	8018833817469	H	5,50

SCHIUMAROLA SMALTO BIANCO 12CM

UV1	UV2	IMBALLO
1	6	1/12 BK



8 0 1 8 8 3 3 8 1 7 4 6 9



ART	BARCODE	ST.	PREZZO
01 22 76	8018833817520	A	5,15

CASSERUOLA 1 MANICO SMALTATO BIANCO/BLU INDUZIONE 12CM

UV1	UV2	IMBALLO
1	12	1/12 BK



8 0 1 8 8 3 3 8 1 7 5 2 0



ART	BARCODE	ST.	PREZZO
01 22 77	8018833817537	A	5,70

CASSERUOLA 1 MANICO SMALTATO BIANCO/BLU INDUZIONE 14CM

UV1	UV2	IMBALLO
1	12	1/12 BK



8 0 1 8 8 3 3 8 1 7 5 3 7



ART	BARCODE	ST.	PREZZO
01 22 75	8018833817889	A	7,55

**COLATUTTO SMALTATO BIANCO/BLU
Ø16CM**

UV1	UV2	IMBALLO
1	6	1/12 BK



8 0 1 8 8 3 3 8 1 7 8 8 9



ART	BARCODE	ST.	PREZZO
01 22 74	8018833817230		9,90

**COLAPASTA SMALTATO BIANCO/BLU
Ø20CM**

UV1	UV2	IMBALLO
1	6	1/6 BK



8 0 1 8 8 3 3 8 1 7 2 3 0



ART	BARCODE	ST.	PREZZO
04 14 91	8018833817629	A	7,10

**BACINELLA SMALTATO BIANCO/BLU
20CM**

UV1	UV2	IMBALLO
1	6	1/12 BK



8 0 1 8 8 3 3 8 1 7 6 2 9



ART	BARCODE	ST.	PREZZO
04 14 92*	8018833817636	H	8,70

**BACINELLA SMALTATO BIANCO/BLU
24CM**

UV1	UV2	IMBALLO
1	6	1/12 BK



8 0 1 8 8 3 3 8 1 7 6 3 6



ART	BARCODE	ST.	PREZZO
04 14 93*	8018833817643	H	10,20

**BACINELLA SMALTATO BIANCO/BLU
28CM**

UV1	UV2	IMBALLO
1	6	1/12 BK



8 0 1 8 8 3 3 8 1 7 6 4 3



ART	BARCODE	ST.	PREZZO
04 14 94*	8018833817650	H	13,80

**BACINELLA SMALTATO BIANCO/BLU
32CM**

UV1	UV2	IMBALLO
1	6	1/6 BK



8 0 1 8 8 3 3 8 1 7 6 5 0



ART	BARCODE	ST.	PREZZO
04 14 95*	8018833817667	H	18,20

**BACINELLA SMALTATO BIANCO/BLU
36CM**

UV1	UV2	IMBALLO
1	6	1/6 BK



8 0 1 8 8 3 3 8 1 7 6 6 7



ART	BARCODE	ST.	PREZZO
04 14 96*	8018833817674	H	23,60

**BACINELLA SMALTATO BIANCO/BLU
40CM**

UV1	UV2	IMBALLO
1	6	1/6 BK



8 0 1 8 8 3 3 8 1 7 6 7 4



ART	BARCODE	ST.	PREZZO
01 22 64	8018833816868		16,70

**BIDONCINO LATTE SMALTATO
BIANCO/BLU 2L**

UV1	UV2	IMBALLO
1	6	1/6 BK



8 0 1 8 8 3 3 8 1 6 8 6 8



ART	BARCODE	ST.	PREZZO
01 22 70	8018833817407		8,00

**SECCHIELLO SMALTATO BIANCO/BLU
Ø14CM**

UV1	UV2	IMBALLO
1	6	1/6 BK



8 0 1 8 8 3 3 8 1 7 4 0 7



ART	BARCODE	ST.	PREZZO
04 15 05	8018833817490		9,25

CATINO SMALTATO BIANCO/BLU Ø28CM

UV1	UV2	IMBALLO
1	12	1/12 BK



8 0 1 8 8 3 3 8 1 7 4 9 0



ART	BARCODE	ST.	PREZZO
04 15 06	8018833817506		11,30

CATINO SMALTATO BIANCO/BLU Ø32CM

UV1	UV2	IMBALLO
1	12	1/12 BK



8 0 1 8 8 3 3 8 1 7 5 0 6



ART	BARCODE	ST.	PREZZO
04 25 31	8018833811252		9,00

VASO DA NOTTE SMALTATO Ø22CM

UV1	UV2	IMBALLO
1	12	1/12 BK



8 0 1 8 8 3 3 8 1 1 2 5 2



ART	BARCODE	ST.	PREZZO
04 14 99	8018833817681		25,70

BROCCA SMALTATO BIANCO/BLU 2,5L

UV1	UV2	IMBALLO
1	6	1/6 BK



8 0 1 8 8 3 3 8 1 7 6 8 1



ART	BARCODE	ST.	PREZZO
01 35 12	8018833810835	A	14,70

ROSTIERA SMALTATA BIANCO/NERO 36 CM

UV1	UV2	IMBALLO
1	6	1/6 BK



8 0 1 8 8 3 3 8 1 0 8 3 5



ART	BARCODE	ST.	PREZZO
01 35 11	8018833810828	A	13,50

ROSTIERA SMALTATA BIANCO/NERO 32 CM

UV1	UV2	IMBALLO
1	6	1/6 BK



8 0 1 8 8 3 3 8 1 0 8 2 8



ART	BARCODE	ST.	PREZZO
01 22 90	8018833855829		5,20

MUG MUCCA SMALTATO 0,3L Ø8CM

UV1	UV2	IMBALLO
1	12	1/12 BK



8 0 1 8 8 3 3 8 5 5 8 2 9



ART	BARCODE	ST.	PREZZO
01 22 95	8018833855898		6,50

TAZZA MUCCA SMALTATO Ø10CM

UV1	UV2	IMBALLO
1	6	1/12 BK



8 0 1 8 8 3 3 8 5 5 8 9 8



ART	BARCODE	ST.	PREZZO
01 22 91	8018833855850		7,50

PIGNATTA MUCCA SMALTATO 0,6L Ø10CM

UV1	UV2	IMBALLO
1	12	1/12 BK



8 0 1 8 8 3 3 8 5 5 8 5 0



ART	BARCODE	ST.	PREZZO
01 22 92	8018833855867		8,60

PIGNATTA MUCCA SMALTATO 1L INDUZIONE 12CM

UV1	UV2	IMBALLO
1	12	1/12 BK



8 0 1 8 8 3 3 8 5 5 8 6 7



ART	BARCODE	ST.	PREZZO
01 22 93	8018833855874		10,15

PIGNATTA MUCCA SMALTATO 1,5L INDUZIONE 14CM

UV1	UV2	IMBALLO
1	12	1/12 BK



8 0 1 8 8 3 3 8 5 5 8 7 4



ART	BARCODE	ST.	PREZZO
01 13 12	9003064700399		19,20

PIGNATTA 'FLORA' SMALTATA Ø10CM 0.75L RIESS

UV1	UV2	IMBALLO
1	2	1/1 BK



9 0 0 3 0 6 4 7 0 0 3 9 9



ART	BARCODE	ST.	PREZZO
01 13 14	9003064700412		27,90

PIGNATTA 'FLORA' SMALTATA INDUZIONE 14CM 1.7L RIESS

UV1	UV2	IMBALLO
1	2	1/1 BK



9 0 0 3 0 6 4 7 0 0 4 1 2



ART	BARCODE	ST.	PREZZO
01 13 13	9003064700405		23,50

PIGNATTA 'FLORA' SMALTATA INDUZIONE 12CM 1.00L RIESS

UV1	UV2	IMBALLO
1	2	1/1 BK



9 0 0 3 0 6 4 7 0 0 4 0 5



ART	BARCODE	ST.	PREZZO
01 81 44	4005643190367	A	9,90

PIGNATTA CON VERSATORE 'PUNTINI' BLU 10CM GSW

UV1	UV2	IMBALLO
1	6	1/1 BK



4 0 0 5 6 4 3 1 9 0 3 6 7



ART	BARCODE	ST.	PREZZO
01 13 73	9003064720571	A	21,50

PIGNATTA 'CERVO' SMALTATA Ø9CM 0,5L RIESS

UV1	UV2	IMBALLO
1	2	1/6 BK



9 0 0 3 0 6 4 7 2 0 5 7 1



ART	BARCODE	ST.	PREZZO
01 14 46	9003064060059		22,50

PIGNATTA 'PASTELL' SMALTATA BLU Ø9CM RIESS

UV1	UV2	IMBALLO
1	6	1/1 BK



9 0 0 3 0 6 4 0 6 0 0 5 9



ART	BARCODE	ST.	PREZZO
01 14 47	9003064060066		24,00

PIGNATTA 'PASTELL' SMALTATA VERDE NILO Ø10CM RIESS

UV1	UV2	IMBALLO
1	3	1/1 BK



9 0 0 3 0 6 4 0 6 0 0 6 6



ART	BARCODE	ST.	PREZZO
01 14 48	9003064060073		25,50

PIGNATTA 'PASTELL' SMALTATA ROSA INDUZIONE 12CM RIESS

UV1	UV2	IMBALLO
1	3	1/1 BK



9 0 0 3 0 6 4 0 6 0 0 7 3



ART	BARCODE	ST.	PREZZO
01 14 49	9003064060080		29,50

PIGNATTA 'PASTELL' SMALTATA TURCHESE INDUZIONE 14CM RIESS

UV1	UV2	IMBALLO
1	3	1/1 BK



9 0 0 3 0 6 4 0 6 0 0 8 0



ART	BARCODE	ST.	PREZZO
01 14 50	9003064060813		22,50

PIGNATTA 1 MANICO 'PASTELL' SMALTATA BLU Ø9CM RIESS

UV1	UV2	IMBALLO
1	3	1/1 BK



9 0 0 3 0 6 4 0 6 0 8 1 3



ART	BARCODE	ST.	PREZZO
01 14 51	9003064060820		23,50

PIGNATTA 1 MANICO 'PASTELL' SMALTATA VERDE NILO Ø10CM RIESS

UV1	UV2	IMBALLO
1	3	1/1 BK



9 0 0 3 0 6 4 0 6 0 8 2 0

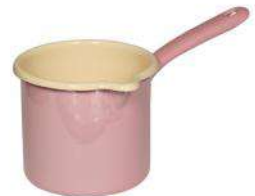

ART	BARCODE	ST.	PREZZO
01 14 52	9003064060837		24,50

PIGNATTA 1 MANICO 'PASTELL' SMALTATA ROSA INDUZIONE 12CM RIESS

UV1	UV2	IMBALLO
1	3	1/1 BK



9 0 0 3 0 6 4 0 6 0 8 3 7



ART	BARCODE	ST.	PREZZO
01 14 44	9003064062442		26,50

MISURA GRADUATA 'PASTELL' SMALTATA ROSA Ø9CM RIESS

UV1	UV2	IMBALLO
1	3	1/1 BK



9 0 0 3 0 6 4 0 6 2 4 4 2



ART	BARCODE	ST.	PREZZO
01 14 45	9003064062459		33,00

MISURA GRADUATA 'PASTELL' SMALTATA TURCHESE Ø10CM RIESS

UV1	UV2	IMBALLO
1	3	1/1 BK



9 0 0 3 0 6 4 0 6 2 4 5 9



ART	BARCODE	ST.	PREZZO
01 14 55	9003064060042		26,50

CASSER.1 MANICO PASTELL SMALTATA GIALLOVERDE INDU 16CM RIESS

UV1	UV2	IMBALLO
1	3	1/1 BK



9 0 0 3 0 6 4 0 6 0 0 4 2



ART	BARCODE	ST.	PREZZO
01 14 59	9003064060882		30,50

PADELLA 'PASTELL' SMALTATA BLU Ø20CM RIESS

UV1	UV2	IMBALLO
1	3	1/1 BK



9 0 0 3 0 6 4 0 6 0 8 8 2



ART	BARCODE	ST.	PREZZO
01 14 60	9003064060899		32,50

PADELLA 'PASTELL' SMALTATA GIALLO INDUZIONE 22CM RIESS

UV1	UV2	IMBALLO
1	3	1/1 BK



9 0 0 3 0 6 4 0 6 0 8 9 9



ART	BARCODE	ST.	PREZZO
01 14 14	9003064060745		22,00

CASSERUOLA BORDO CROM. PASTELL SMALTATA ROSA INDU 12CM RIESS

UV1	UV2	IMBALLO
1	3	1/1 BK



9 0 0 3 0 6 4 0 6 0 7 4 5



ART	BARCODE	ST.	PREZZO
01 14 15	9003064060752		24,00

CASSER.BORDO CROM PASTELL SMALTATA TURCHESE INDUK 14CM RIESS

UV1	UV2	IMBALLO
1	3	1/1 BK



9 0 0 3 0 6 4 0 6 0 7 5 2



ART	BARCODE	ST.	PREZZO
01 14 16	9003064060769		26,50

CASSER.BORDO CROM PASTELL SMALTATA GIALLOVERDE IND16CM RIESS

UV1	UV2	IMBALLO
1	3	1/1 BK



9 0 0 3 0 6 4 0 6 0 7 6 9



ART	BARCODE	ST.	PREZZO
01 14 17	9003064060776		30,50

CASSERUOLA BORDO CROMATO PASTELL SMALTATA BLU IND 18CM RIESS

UV1	UV2	IMBALLO
1	3	1/1 BK



9 0 0 3 0 6 4 0 6 0 7 7 6



ART	BARCODE	ST.	PREZZO
01 14 18	9003064060783		33,50

CASSER.BORDO CROM.PASTELL SMALTATA GIALLO INDUZION 20CM RIESS

UV1	UV2	IMBALLO
1	3	1/1 BK



9 0 0 3 0 6 4 0 6 0 7 8 3



ART	BARCODE	ST.	PREZZO
01 14 19	9003064060790		38,50

CASSER.BORDO CROM.PASTELL SMALTATA VERDE NILO IND 22CM RIESS

UV1	UV2	IMBALLO
1	3	1/1 BK



9 0 0 3 0 6 4 0 6 0 7 9 0



ART	BARCODE	ST.	PREZZO
01 14 20	9003064060806		48,00

CASSER.BORDO CROMATO PASTELL SMALTATA BLU INDUZION 24CM RIESS

UV1	UV2	IMBALLO
1	3	1/1 BK



9 0 0 3 0 6 4 0 6 0 8 0 6



ART	BARCODE	ST.	PREZZO
01 14 22	9003064060721		54,00

PENTOLA BORDO CROM.PASTELL SMALTATA VERDE NILO IND22CM RIESS

UV1	UV2	IMBALLO
1	3	1/1 BK



9 0 0 3 0 6 4 0 6 0 7 2 1



ART	BARCODE	ST.	PREZZO
01 14 23	9003064060738		65,00

PENTOLA BORDO CROMATO PASTELL SMALTATA BLU IND 24CM RIESS

UV1	UV2	IMBALLO
1	2	1/1 BK



9 0 0 3 0 6 4 0 6 0 7 3 8



ART	BARCODE	ST.	PREZZO
01 14 25	9003064060318		16,50

COPERCHIO BORDO CROMATO 'PASTELL' SMALTATO ROSA Ø12CM RIESS

UV1	UV2	IMBALLO
1	3	1/1 BK



9 0 0 3 0 6 4 0 6 0 3 1 8



ART	BARCODE	ST.	PREZZO
01 14 26	9003064060264		17,50

**COPERCHIO BORDO CROM.'PASTELL'
SMALTATO TURCHESE Ø14CM RIESS**

UV1	UV2	IMBALLO
1	3	1/1 BK



9 0 0 3 0 6 4 0 6 0 2 6 4



ART	BARCODE	ST.	PREZZO
01 14 27	9003064060271		19,00

**COPER. BORDO CROM.'PASTELL'
SMALTATO GIALLOVERDE Ø16CM RIESS**

UV1	UV2	IMBALLO
1	3	1/1 BK



9 0 0 3 0 6 4 0 6 0 2 7 1



ART	BARCODE	ST.	PREZZO
01 14 28	9003064060288		21,50

**COPERCHIO BORDO CROMATO
'PASTELL' SMALTATO BLU Ø18CM RIESS**

UV1	UV2	IMBALLO
1	3	1/1 BK



9 0 0 3 0 6 4 0 6 0 2 8 8



ART	BARCODE	ST.	PREZZO
01 14 29	9003064060295		22,50

**COPER. BORDO CROM.'PASTELL'
SMALTATO GIALLO ORO Ø20CM RIESS**

UV1	UV2	IMBALLO
1	3	1/1 BK



9 0 0 3 0 6 4 0 6 0 2 9 5



ART	BARCODE	ST.	PREZZO
01 14 30	9003064060301		24,00

**COPER.BORDO CROM. 'PASTELL'
SMALTATO VERDE NILO Ø22CM RIESS**

UV1	UV2	IMBALLO
1	3	1/1 BK



9 0 0 3 0 6 4 0 6 0 3 0 1



ART	BARCODE	ST.	PREZZO
01 14 31	9003064060325		25,00

**COPERCHIO BORDO CROMATO
'PASTELL' SMALTATO BLU Ø24CM RIESS**

UV1	UV2	IMBALLO
1	3	1/1 BK



9 0 0 3 0 6 4 0 6 0 3 2 5



ART	BARCODE	ST.	PREZZO
01 14 75	9003064062480		48,50

**FUSTINO LATTE 'PASTEL' SMALTATA
BLU 1,5L RIESS**

UV1	UV2	IMBALLO
1	3	1/1 BK



9 0 0 3 0 6 4 0 6 2 4 8 0



ART	BARCODE	ST.	PREZZO
01 15 25	4005643189972		61,00

**6 PEZZI SET PENTOLE 'HORTENSIE'
SMALTO INDUZIONE GSW**

UV1	UV2	IMBALLO
1	2	1/1 BK



4 0 0 5 6 4 3 1 8 9 9 7 2



ART	BARCODE	ST.	PREZZO
01 13 32	9003064250351		23,00

**PIGNATTA "HOTEL" SMALTATA
INDUZIONE 1L 12CM RIESS**

UV1	UV2	IMBALLO
1	6	1/1 BK



9 0 0 3 0 6 4 2 5 0 3 5 1



ART	BARCODE	ST.	PREZZO
01 13 33	9003064250368		25,50

**PIGNATTA "HOTEL" SMALTATA
INDUZIONE 1,7L Ø14CM RIESS**

UV1	UV2	IMBALLO
1	6	1/1 BK



9 0 0 3 0 6 4 2 5 0 3 6 8



ART	BARCODE	ST.	PREZZO
01 13 34	9003064250382		27,00

**PIGNATTA "HOTEL" SMALTATA
INDUZIONE 2L 16CM RIESS**

UV1	UV2	IMBALLO
1	6	1/1 BK



9 0 0 3 0 6 4 2 5 0 3 8 2



ART	BARCODE	ST.	PREZZO
01 12 47	4005643255165		10,50

**CASSERUOLA PROFI 'BLACK STAR'
SMALTATA INDUZIONE 16CM GSW**

UV1	UV2	IMBALLO
1	2	1/6 CL



4 0 0 5 6 4 3 2 5 5 1 6 5



ART	BARCODE	ST.	PREZZO
01 12 49	4005643255141		12,50

BRICCO LATTE PROFI 'BLACK STAR'
SMALTATA INDUZIONE 14CM GSW

UV1	UV2	IMBALLO
1	2	1/6 CL



4 0 0 5 6 4 3 2 5 5 1 4 1



ART	BARCODE	ST.	PREZZO
01 12 41	4005643253161		14,50

TEGAME + COPERCHIO PROFI 'BLACK STAR'
INDUZIONE 16x8CM GSW

UV1	UV2	IMBALLO
1	2	1/6 SP



4 0 0 5 6 4 3 2 5 3 1 6 1



ART	BARCODE	ST.	PREZZO
01 12 42	4005643253208		18,50

TEGAME+COPERCHIO PROFI 'BLACK STAR'
INDUZIONE 20x10CM GSW

UV1	UV2	IMBALLO
1	2	1/6 SP



4 0 0 5 6 4 3 2 5 3 2 0 8



ART	BARCODE	ST.	PREZZO
01 12 44	4005643254168		16,00

PENTOLA+COPERCHIO PROFI 'BLACK STAR'
INDUZIONE 16x10CM GSW

UV1	UV2	IMBALLO
1	2	1/6 SP



4 0 0 5 6 4 3 2 5 4 1 6 8



ART	BARCODE	ST.	PREZZO
01 12 45	4005643254205		20,50

PENTOLA+COPERCHIO PROFI 'BLACK STAR'
INDUZIONE 20x13,5CM GSW

UV1	UV2	IMBALLO
1	2	1/6 SP



4 0 0 5 6 4 3 2 5 4 2 0 5



ART	BARCODE	ST.	PREZZO
01 12 46	4005643254243		26,50

PENTOLA+COPERCHIO PROFI 'BLACK STAR'
INDUZIONE 24x13CM GSW

UV1	UV2	IMBALLO
1	2	1/4 SP



4 0 0 5 6 4 3 2 5 4 2 4 3



ART	BARCODE	ST.	PREZZO
01 36 28	9003064061483		29,00

PADELLA MANICO LEGNO 'CLASSIC'
SMALTATA NERO 24 CM RIESS

UV1	UV2	IMBALLO
1	2	1/1 BK



9 0 0 3 0 6 4 0 6 1 4 8 3



ART	BARCODE	ST.	PREZZO
01 40 28	9003064046015	A	16,00

SERVI-PADELLA ROTONDO IN LEGNO
20/24CM RIESS

UV1	UV2	IMBALLO
1	2	1/1 SP



9 0 0 3 0 6 4 0 4 6 0 1 5



ART	BARCODE	ST.	PREZZO
01 40 29	9003064046008	A	20,50

SERVI-PADELLA ROTONDO CON MANICO
IN LEGNO 20/24CM RIESS

UV1	UV2	IMBALLO
1	2	1/1 SP



9 0 0 3 0 6 4 0 4 6 0 0 8



ART	BARCODE	ST.	PREZZO
01 40 30	9003064046022	A	16,00

SERVI-ROSTIERA RETTANGOLARE IN
LEGNO 26/17CM RIESS

UV1	UV2	IMBALLO
1	2	1/1 SP



9 0 0 3 0 6 4 0 4 6 0 2 2



ART	BARCODE	ST.	PREZZO
01 13 42	9003064220460		54,50

ROSTIERA CON COPERCHIO 'CLASSIC'
SMALTO NERO 26X26CM RIESS

UV1	UV2	IMBALLO
1	2	1/1 PB



9 0 0 3 0 6 4 2 2 0 4 6 0



ART	BARCODE	ST.	PREZZO
01 13 43	9003064220040		69,00

ROSTIERA CON COPERCHIO 'CLASSIC'
SMALTO NERO 37X26CM RIESS

UV1	UV2	IMBALLO
1	2	1/1 PB



9 0 0 3 0 6 4 2 2 0 0 4 0



ART	BARCODE	ST.	PREZZO
01 35 05	4005643400374	A	32,50

ROSTIERA OVALE CON COPERCHIO
SMALTO INDUZIONE 34CM-5,7L GSW

UV1	UV2	IMBALLO
1	2	1/1 SP



4 0 0 5 6 4 3 4 0 0 3 7 4



ART	BARCODE	ST.	PREZZO
01 35 06	4005643400381	A	39,50

ROSTIERA OVALE CON COPERCHIO
SMALTO INDUZIONE 38CM-9,0L GSW

UV1	UV2	IMBALLO
1	2	1/1 SP



4 0 0 5 6 4 3 4 0 0 3 8 1



ART	BARCODE	ST.	PREZZO
01 13 41	9003064220705		32,00

ROSTIERA 'CLASSIC' SMALTO NERO
22X22CM RIESS

UV1	UV2	IMBALLO
1	2	1/1 PB



9 0 0 3 0 6 4 2 2 0 7 0 5



ART	BARCODE	ST.	PREZZO
01 13 39	9003064220125		25,50

PIROFILA 'CLASSIC' SMALTATA NERO
32X19CM RIESS

UV1	UV2	IMBALLO
1	3	1/1 BK



9 0 0 3 0 6 4 2 2 0 1 2 5



ART	BARCODE	ST.	PREZZO
01 13 40	9003064220057		28,50

PIROFILA 'CLASSIC' SMALTATA NERO
36X21CM RIESS

UV1	UV2	IMBALLO
1	3	1/1 BK



9 0 0 3 0 6 4 2 2 0 0 5 7



ART	BARCODE	ST.	PREZZO
01 35 15	9003064062060	A	27,50

PIROFILA 'CLASSIC' SMALTATA NERA
29X18CM RIESS

UV1	UV2	IMBALLO
1	3	1/1 BK



9 0 0 3 0 6 4 0 6 2 0 6 0



ART	BARCODE	ST.	PREZZO
01 35 16	9003064062077	A	29,50

PIROFILA 'CLASSIC' SMALTATA NERA
33X20CM RIESS

UV1	UV2	IMBALLO
1	3	1/1 BK



9 0 0 3 0 6 4 0 6 2 0 7 7



ART	BARCODE	ST.	PREZZO
01 35 17	9003064062084	A	33,00

PIROFILA 'CLASSIC' SMALTATA NERA
37X22CM RIESS

UV1	UV2	IMBALLO
1	3	1/1 BK



9 0 0 3 0 6 4 0 6 2 0 8 4



ART	BARCODE	ST.	PREZZO
01 36 30	9003064061452		32,50

PADELLA PER FRIGGERE SMALTATA
NERA INDUZIONE 24CM RIESS

UV1	UV2	IMBALLO
1	3	1/1 BK



9 0 0 3 0 6 4 0 6 1 4 5 2



ART	BARCODE	ST.	PREZZO
01 36 31	9003064061469		45,00

PADELLA PER FRIGGERE SMALTATA
NERA INDUZIONE 30CM RIESS

UV1	UV2	IMBALLO
1	3	1/1 BK



9 0 0 3 0 6 4 0 6 1 4 6 9



ART	BARCODE	ST.	PREZZO
01 36 36	9003064220989		53,00

PADELLA PER FRIGGERE SMALTATA
NERA INDUZIONE 34CM RIESS

UV1	UV2	IMBALLO
1	2	1/1 BK



9 0 0 3 0 6 4 2 2 0 9 8 9



ART	BARCODE	ST.	PREZZO
01 36 32	9003064062008		68,50

PADELLA PER FRIGGERE SMALTATA
NERA INDUZIONE 40CM RIESS

UV1	UV2	IMBALLO
1	3	1/1 BK



9 0 0 3 0 6 4 0 6 2 0 0 8



ART	BARCODE	ST.	PREZZO
01 36 37	9003064220194		24,50

TEGAME 'CLASSIC' SMALTATA NERA
INDUZIONE 20CM RIESS

UV1	UV2	IMBALLO
1	3	1/1 BK



9 0 0 3 0 6 4 2 2 0 1 9 4



ART	BARCODE	ST.	PREZZO
01 36 33	9003064220200		26,00

TEGAME 'CLASSIC' SMALTATA NERA
INDUZIONE 24CM RIESS

UV1	UV2	IMBALLO
1	3	1/1 BK



9 0 0 3 0 6 4 2 2 0 2 0 0



ART	BARCODE	ST.	PREZZO
01 36 34	9003064220224		29,00

TEGAME 'CLASSIC' SMALTATA NERA
INDUZIONE 26CM RIESS

UV1	UV2	IMBALLO
1	3	1/1 BK



9 0 0 3 0 6 4 2 2 0 2 2 4



ART	BARCODE	ST.	PREZZO
01 36 35	9003064220231		41,00

TEGAME 'CLASSIC' SMALTATA NERA
INDUZIONE 30CM RIESS

UV1	UV2	IMBALLO
1	3	1/1 BK



9 0 0 3 0 6 4 2 2 0 2 3 1



ART	BARCODE	ST.	PREZZO
01 13 87	9003064220835		32,00

TEGAME 2 MANICI 'SMALTO NERO' 20 CM
RIESS

UV1	UV2	IMBALLO
1	2	1/1 AL



9 0 0 3 0 6 4 2 2 0 8 3 5



ART	BARCODE	ST.	PREZZO
01 13 88	9003064220842		34,00

TEGAME 2 MANICI 'SMALTO NERO' 24 CM
RIESS

UV1	UV2	IMBALLO
1	2	1/1 AL



9 0 0 3 0 6 4 2 2 0 8 4 2



ART	BARCODE	ST.	PREZZO
01 13 89	9003064220811		46,50

TEGAME 2 MANICI 'SMALTO NERO' 28 CM
RIESS

UV1	UV2	IMBALLO
1	2	1/1 AL



9 0 0 3 0 6 4 2 2 0 8 1 1



ART	BARCODE	ST.	PREZZO
01 12 39	3216383138392		11,50

PENTOLA+COPERCHIO CUOCI-COZZE
(1KG) INDUZIONE 18CM GSW

UV1	UV2	IMBALLO
1	4	1/6 SP



3 2 1 6 3 8 3 1 3 8 3 9 2



ART	BARCODE	ST.	PREZZO
01 12 40	4260492490338	A	16,90

PENTOLA+COPERCHIO CUOCI-COZZE
(2KG) INDUZIONE 24CM

UV1	UV2	IMBALLO
1	4	1/4 SP



4 2 6 0 4 9 2 4 9 0 3 3 8



ART	BARCODE	ST.	PREZZO
01 13 86	9003064221399		23,50

PADELLA SMALTATA MINI 'NERO' 16 CM
RIESS

UV1	UV2	IMBALLO
1	2	1/1 AL



9 0 0 3 0 6 4 2 2 1 3 9 9



ART	BARCODE	ST.	PREZZO
01 13 85	9003064200479		23,50

PADELLA SMALTATA MINI 'ROSSO/NERO'
16 CM RIESS

UV1	UV2	IMBALLO
1	2	1/1 AL



9 0 0 3 0 6 4 2 0 0 4 7 9



ART	BARCODE	ST.	PREZZO
01 13 45	9003064120838		33,00

PADELLA SMALTATA 'BLU COBALTO' 20
CM RIESS

UV1	UV2	IMBALLO
1	2	1/1 BK



9 0 0 3 0 6 4 1 2 0 8 3 8



ART	BARCODE	ST.	PREZZO
01 13 46	9003064120821		38,00

PADELLA SMALTATA 'BLU COBALTO' 24 CM RIESS

UV1	UV2	IMBALLO
1	2	1/1 BK



9 0 0 3 0 6 4 1 2 0 8 2 1



ART	BARCODE	ST.	PREZZO
01 13 47	9003064120852		49,50

PADELLA SMALTATA 'BLU COBALTO' 28 CM RIESS

UV1	UV2	IMBALLO
1	2	1/1 BK



9 0 0 3 0 6 4 1 2 0 8 5 2



ART	BARCODE	ST.	PREZZO
11 06 01	9003064220644		29,00

PADELLA CASTAGNE SMALTO NERO+MANICO LEGNO 26CM RIESS

UV1	UV2	IMBALLO
1	2	1/1 BK



9 0 0 3 0 6 4 2 2 0 6 4 4

Tagliare Tritare Sminuzzare



ART	BARCODE	ST.	PREZZO
05 32 71*	8004537532715	H	3,95

SPELUCCHINO LAMA ANTIADERENTE 8,8 CM EVA

UV1	UV2	IMBALLO
1	6	1/12/48 DC



8 0 0 4 5 3 7 5 3 2 7 1 5



ART	BARCODE	ST.	PREZZO
05 32 72*	8004537532722	H	3,95

COLTELLO UNIVERSALE LAMA ANTIADERENTE 14 CM EVA

UV1	UV2	IMBALLO
1	6	1/12/48 DC



8 0 0 4 5 3 7 5 3 2 7 2 2



ART	BARCODE	ST.	PREZZO
05 32 74*	8004537532746	H	6,90

COLTELLO PANE LAMA ANTIADERENTE 20,3 CM EVA

UV1	UV2	IMBALLO
1	6	1/12/48 DC



8 0 0 4 5 3 7 5 3 2 7 4 6



ART	BARCODE	ST.	PREZZO
05 32 75*	8004537532753	H	6,90

COLTELLO CUCINA LAMA ANTIADERENTE 20,3 CM EVA

UV1	UV2	IMBALLO
1	6	1/12/48 DC



8 0 0 4 5 3 7 5 3 2 7 5 3



ART	BARCODE	ST.	PREZZO
05 32 76*	8004537532760	H	6,90

COLTELLO CHEF LAMA ANTIADERENTE 20,3 CM EVA

UV1	UV2	IMBALLO
1	6	1/12/48 DC



8 0 0 4 5 3 7 5 3 2 7 6 0



ART	BARCODE	ST.	PREZZO
05 30 80	4004094145285		5,20

SPELUCCHINO LAMA ANTIADERENTE 8 CM WESTMARK

UV1	UV2	IMBALLO
1	6	1/6/36 DC



4 0 0 4 0 9 4 1 4 5 2 8 5



ART	BARCODE	ST.	PREZZO
05 30 81	4004094145384		5,30

COLTELLO UNIVERSALE LAMA ANTIADERENTE 12 CM WESTMARK

UV1	UV2	IMBALLO
1	6	1/6/36 DC



4 0 0 4 0 9 4 1 4 5 3 8 4



ART	BARCODE	ST.	PREZZO
05 30 82	4004094145483		9,50

COLTELLO CHEF LAMA ANTIADERENTE 20 CM WESTMARK

UV1	UV2	IMBALLO
1	6	1/6/36 DC



4 0 0 4 0 9 4 1 4 5 4 8 3



ART	BARCODE	ST.	PREZZO
05 30 83	4004094145582		9,50

COLTELLO PANE LAMA ANTIADERENTE 20 CM WESTMARK

UV1	UV2	IMBALLO
1	6	1/6/36 DC



4 0 0 4 0 9 4 1 4 5 5 8 2



ART	BARCODE	ST.	PREZZO
05 30 84	4004094145681		9,50

COLTELLO SANTOKU LAMA ANTIADERENTE 17 CM WESTMARK

UV1	UV2	IMBALLO
1	6	1/6/36 DC



4 0 0 4 0 9 4 1 4 5 6 8 1



ART	BARCODE	ST.	PREZZO
05 33 01	4010303041637		3,65

SPELUCCHINO LAMA LISCA 6CM GIESSER

UV1	UV2	IMBALLO
1	20	1/20 BK



4 0 1 0 3 0 3 0 4 1 6 3 7



ART	BARCODE	ST.	PREZZO
05 33 02	4010303038415		3,90

SPELUCCHINO LAMA LISCIA 10 CM GIESSER

UV1	UV2	IMBALLO
1	20	1/20 BK



4 0 1 0 3 0 3 0 3 8 4 1 5



ART	BARCODE	ST.	PREZZO
05 33 03	4010303051889		3,90

COLTELLO UNIVERSALE LAMA LISCIA 11CM GIESSER

UV1	UV2	IMBALLO
1	20	1/20 BK



4 0 1 0 3 0 3 0 5 1 8 8 9



ART	BARCODE	ST.	PREZZO
05 33 04	4010303051865		3,95

COLTELLO UNIVERSALE SEGHETTATO 11CM GIESSER

UV1	UV2	IMBALLO
1	20	1/20 BK



4 0 1 0 3 0 3 0 5 1 8 6 5



ART	BARCODE	ST.	PREZZO
05 33 05	4010303042030		3,95

COLTELLO BISTECCA LAMA LISCIA 11CM GIESSER

UV1	UV2	IMBALLO
1	20	1/20 BK



4 0 1 0 3 0 3 0 4 2 0 3 0



ART	BARCODE	ST.	PREZZO
05 33 11	4010303038804		11,60

COLTELLO DA CUCINA LAMA LISCIA 13CM GIESSER

UV1	UV2	IMBALLO
1	6	1/6 PH



4 0 1 0 3 0 3 0 3 8 8 0 4



ART	BARCODE	ST.	PREZZO
05 33 13	4010303041071		18,50

COLTELLO DA CUCINA LAMA LISCIA 20CM GIESSER

UV1	UV2	IMBALLO
1	6	1/6 PH



4 0 1 0 3 0 3 0 4 1 0 7 1



ART	BARCODE	ST.	PREZZO
05 33 16	4010303041026		15,70

COLTELLO DA CUOCO LAMA LISCIA 16CM GIESSER

UV1	UV2	IMBALLO
1	6	1/6 PH



4 0 1 0 3 0 3 0 4 1 0 2 6



ART	BARCODE	ST.	PREZZO
05 33 17	4010303041033		16,70

COLTELLO DA CUOCO LAMA LISCIA 18CM GIESSER

UV1	UV2	IMBALLO
1	6	1/6 PH



4 0 1 0 3 0 3 0 4 1 0 3 3



ART	BARCODE	ST.	PREZZO
05 33 18	4010303041040		17,30

COLTELLO DA CUOCO LAMA LISCIA 20CM GIESSER

UV1	UV2	IMBALLO
1	6	1/6 PH



4 0 1 0 3 0 3 0 4 1 0 4 0



ART	BARCODE	ST.	PREZZO
05 33 22	4010303040029		19,30

COLTELLO PER PANE LAMA SEGHETTATA 21CM GIESSER

UV1	UV2	IMBALLO
1	6	1/6 PH



4 0 1 0 3 0 3 0 4 0 0 2 9



ART	BARCODE	ST.	PREZZO
05 33 27	4010303007701		23,90

ACCIAINO 25CM GIESSER

UV1	UV2	IMBALLO
1	2	1/5 SL



4 0 1 0 3 0 3 0 0 7 7 0 1



ART	BARCODE	ST.	PREZZO
05 32 20	8004537532203		14,10

2 COLTELLI ANTIADERENTI 15/20 CM EVA

UV1	UV2	IMBALLO
1	3	1/24/48 WB



8 0 0 4 5 3 7 5 3 2 2 0 3



ART	BARCODE	ST.	PREZZO
05 32 25	8004537532258	A	10,30

6 COLTELLI LAMA SEGHETTATA EVA

UV1	UV2	IMBALLO
1	6	1/18/36 PV



8 0 0 4 5 3 7 5 3 2 2 5 8



ART	BARCODE	ST.	PREZZO
05 32 26	8004537532265	A	10,30

6 COLTELLI LAMA LISCIA EVA

UV1	UV2	IMBALLO
1	6	1/18/36 PV



8 0 0 4 5 3 7 5 3 2 2 6 5



ART	BARCODE	ST.	PREZZO
05 30 01	4010303257908	A	320,00

SET 3 COLTELLI 'PREMIUM CUT' GIESSER

UV1	UV2	IMBALLO
1	2	1/1 BW



4 0 1 0 3 0 3 2 5 7 9 0 8



ART	BARCODE	ST.	PREZZO
05 30 02	4010303229837	A	92,50

COLTELLO PER FILETTO 'PREMIUM CUT' 17CM GIESSER

UV1	UV2	IMBALLO
1	2	1/1 BW



4 0 1 0 3 0 3 2 2 9 8 3 7



ART	BARCODE	ST.	PREZZO
05 30 30	4010303043976		6,30

COLTELLO VERDURA 'PRIMELINE CHEF' 8CM GIESSER

UV1	UV2	IMBALLO
1	6	1/6 PH



4 0 1 0 3 0 3 0 4 3 9 7 6



ART	BARCODE	ST.	PREZZO
05 30 31	4010303043983		7,10

COLTELLO VERDURA 'PRIMELINE CHEF' 10CM GIESSER

UV1	UV2	IMBALLO
1	6	1/6 PH



4 0 1 0 3 0 3 0 4 3 9 8 3



ART	BARCODE	ST.	PREZZO
05 30 32	4010303043990		7,10

COLTELLO UNIVERSALE SEGHETTATO 'PRIMELINE CHEF' 11CM GIESSER

UV1	UV2	IMBALLO
1	6	1/6 PH



4 0 1 0 3 0 3 0 4 3 9 9 0



ART	BARCODE	ST.	PREZZO
05 30 33	4010303035476		17,40

COLTELLO CUCINA PUNTA MEDIA 'PRIMELINE CHEF' 13CM GIESSER

UV1	UV2	IMBALLO
1	6	1/6 PH



4 0 1 0 3 0 3 0 3 5 4 7 6



ART	BARCODE	ST.	PREZZO
05 30 34	4010303035445		20,50

COLTELLO CHEF BASSO 'PRIMELINE CHEF' 16CM GIESSER

UV1	UV2	IMBALLO
1	6	1/6 PH



4 0 1 0 3 0 3 0 3 5 4 4 5



ART	BARCODE	ST.	PREZZO
05 30 35	4010303035469		22,30

COLTELLO CHEF BASSO 'PRIMELINE CHEF' 18CM GIESSER

UV1	UV2	IMBALLO
1	6	1/6 PH



4 0 1 0 3 0 3 0 3 5 4 6 9



ART	BARCODE	ST.	PREZZO
05 30 36	4010303035414		23,80

COLTELLO CHEF ALTO 'PRIMELINE CHEF' 20CM GIESSER

UV1	UV2	IMBALLO
1	6	1/6 PH



4 0 1 0 3 0 3 0 3 5 4 1 4



ART	BARCODE	ST.	PREZZO
05 30 37	4010303035421		26,80

COLTELLO CHEF ALTO 'PRIMELINE CHEF' 23CM GIESSER

UV1	UV2	IMBALLO
1	6	1/6 PH



4 0 1 0 3 0 3 0 3 5 4 2 1



ART	BARCODE	ST.	PREZZO
05 30 46	4010303106534	A	45,50

COLTELLO DEBA 'PRIMELINE CHEF' 15CM GIESSER

UV1	UV2	IMBALLO
1	6	1/6 PH



4 0 1 0 3 0 3 1 0 6 5 3 4



ART	BARCODE	ST.	PREZZO
05 30 38	4010303043969		28,40

COLTELLO SANTOKU SCANALATURE 'PRIMELINE CHEF' 18CM GIESSER

UV1	UV2	IMBALLO
1	6	1/6 PH



4 0 1 0 3 0 3 0 4 3 9 6 9



ART	BARCODE	ST.	PREZZO
05 30 40	4010303043921		22,30

COLTELLO PER SFILETTARE 'PRIMELINE CHEF' 16CM GIESSER

UV1	UV2	IMBALLO
1	6	1/6 PH



4 0 1 0 3 0 3 0 4 3 9 2 1



ART	BARCODE	ST.	PREZZO
05 30 41	4010303035483		22,30

COLTELLO PER SFILETTARE 'PRIMELINE CHEF' 18CM GIESSER

UV1	UV2	IMBALLO
1	6	1/6 PH



4 0 1 0 3 0 3 0 3 5 4 8 3



ART	BARCODE	ST.	PREZZO
05 30 42	4010303044638		22,30

COLTELLO PER PANE SEGHETTATO 'PRIMELINE CHEF' 21CM GIESSER

UV1	UV2	IMBALLO
1	6	1/6 PH



4 0 1 0 3 0 3 0 4 4 6 3 8



ART	BARCODE	ST.	PREZZO
05 30 44	4010303045369	A	29,00

COLTELLO SEGHETTATO 'PRIMELINE CHEF' 22CM GIESSER

UV1	UV2	IMBALLO
1	6	1/6 PH



4 0 1 0 3 0 3 0 4 5 3 6 9



ART	BARCODE	ST.	PREZZO
05 30 47	4010303106527	A	48,00

COLTELLO YANAGIBA 'PRIMELINE CHEF' 24CM GIESSER

UV1	UV2	IMBALLO
1	6	1/6 PH



4 0 1 0 3 0 3 1 0 6 5 2 7



ART	BARCODE	ST.	PREZZO
05 30 48	4010303108460		41,50

ACCIAINO 'PRIMELINE CHEF' 31CM GIESSER

UV1	UV2	IMBALLO
1	6	1/4 SL



4 0 1 0 3 0 3 1 0 8 4 6 0



ART	BARCODE	ST.	PREZZO
05 30 50	4010303072457		50,50

BORSA PORTA-COLTELLI VERDE VUOTA PER 8 COLTELLI GIESSER

UV1	UV2	IMBALLO
1	2	1/1 SL



4 0 1 0 3 0 3 0 7 2 4 5 7



ART	BARCODE	ST.	PREZZO
05 30 51	4010303072440		70,50

BORSA PORTA-COLTELLI ROSSA VUOTA PER 10 COLTELLI GIESSER

UV1	UV2	IMBALLO
1	2	1/1 SL



4 0 1 0 3 0 3 0 7 2 4 4 0



ART	BARCODE	ST.	PREZZO
05 32 08	4008502502455	H	12,90

COLTELLO PER PANE MANICO NERO IN DISPLAY

UV1	UV2	IMBALLO
12	24	1/12 DB



4 0 0 8 5 0 2 5 0 2 4 5 5



ART	BARCODE	ST.	PREZZO
05 32 07	4008502501748		4,25

SPELUCCHINO 6CM IN DISPLAY

UV1	UV2	IMBALLO
20	40	1/20 DB



4 0 0 8 5 0 2 5 0 1 7 4 8



ART	BARCODE	ST.	PREZZO
05 32 04	4008502501274		2,90

SPELUCCHINO DENTATO 10CM IN DISPLAY

UV1	UV2	IMBALLO
20	40	1/20 DB



4 0 0 8 5 0 2 5 0 1 2 7 4



ART	BARCODE	ST.	PREZZO
05 32 02	4008502512799	A	3,20

SPELUCCHINO DENTATO 'DIAMANT'
12CM IN DISPLAY

UV1	UV2	IMBALLO
20	40	1/20 DB



4 0 0 8 5 0 2 5 1 2 7 9 9



ART	BARCODE	ST.	PREZZO
05 32 01	4008502519514	A	3,20

COLTELLO PER PIZZA DENTATO
'DIAMANT' 10CM IN DISPLAY

UV1	UV2	IMBALLO
25	50	1/25 DB



4 0 0 8 5 0 2 5 1 9 5 1 4



ART	BARCODE	ST.	PREZZO
05 06 17	9003730111047		7,95

COLTELLO SPECK MAN LEGNO ACCIAIO
INOSSIDABILE HACK

UV1	UV2	IMBALLO
1	12	1/12 PG



9 0 0 3 7 3 0 1 1 1 0 4 7



ART	BARCODE	ST.	PREZZO
05 31 30	8004537531305	A	3,30

6 COLTELLI TAVOLA 11CM BIANCO EVA

UV1	UV2	IMBALLO
1	10	1/20/120 BC



8 0 0 4 5 3 7 5 3 1 3 0 5



ART	BARCODE	ST.	PREZZO
05 31 31	8004537531312		3,30

6 COLTELLI TAVOLA NERO 11CM EVA

UV1	UV2	IMBALLO
1	10	1/20/120 BC



8 0 0 4 5 3 7 5 3 1 3 1 2



ART	BARCODE	ST.	PREZZO
05 31 32	8004537531329	A	3,30

6 COLTELLI TAVOLA 11CM ROSSO EVA

UV1	UV2	IMBALLO
1	10	1/20/120 BC



8 0 0 4 5 3 7 5 3 1 3 2 9



ART	BARCODE	ST.	PREZZO
05 31 33	8004537531336		3,30

6 COLTELLI TAVOLA MARRONE 11CM
EVA

UV1	UV2	IMBALLO
1	10	1/100 BC



8 0 0 4 5 3 7 5 3 1 3 3 6



ART	BARCODE	ST.	PREZZO
05 31 39	8004537531398	A	3,30

6 COLTELLI TAVOLA TORTORA 11CM
EVA

UV1	UV2	IMBALLO
1	10	1/20/120 BC



8 0 0 4 5 3 7 5 3 1 3 9 8



ART	BARCODE	ST.	PREZZO
05 32 05*	4008502501564	H	3,80

COLTELLO 4D SUPER-AFFILATO 11,5CM
ASSORTITO IN DISPLAY

UV1	UV2	IMBALLO
20	40	1/20 DB



4 0 0 8 5 0 2 5 0 1 5 6 4



ART	BARCODE	ST.	PREZZO
05 33 52	4010303004908		4,00

SPELUCCHINO COLORI ASSORTITI LAMA
LISCIA 10CM GIESSER

UV1	UV2	IMBALLO
20	60	1/20 BK



4 0 1 0 3 0 3 0 0 4 9 0 8



ART	BARCODE	ST.	PREZZO
05 33 54	4010303002133		4,00

COLTELLO UNIVERSALE COLORI
ASSORTITI SEGHETTATO 11CM GIESSER

UV1	UV2	IMBALLO
20	60	1/20 BK



4 0 1 0 3 0 3 0 0 2 1 3 3



ART	BARCODE	ST.	PREZZO
05 33 56	4010303088045		3,90

COLTELLO UNIVERSALE
COLOR.SEGHETTATO 11CM IN DISPLAY
GIESSER

UV1	UV2	IMBALLO
60	120	1/60 DB



4 0 1 0 3 0 3 0 8 8 0 4 5



ART	BARCODE	ST.	PREZZO
04 02 60	8004537402605		6,95

SPELUCCHINO 10CM ANTIADERENTE ASSORTITO IN DISPLAY M+K

UV1	UV2	IMBALLO
36	144	1/36/144 DB



8 0 0 4 5 3 7 4 0 2 6 0 5



ART	BARCODE	ST.	PREZZO
05 03 95	4004094101762		23,90

AFFILACOLTELLI DELUXE NERO 20X4,6 CM WESTMARK

UV1	UV2	IMBALLO
1	4	1/4/32 HB



4 0 0 4 0 9 4 1 0 1 7 6 2



ART	BARCODE	ST.	PREZZO
05 32 80	4008502102419		7,90

BARRA MAGNETICA PORTA-COLTELLI 33,5CM

UV1	UV2	IMBALLO
1	10	1/25 BC



4 0 0 8 5 0 2 1 0 2 4 1 9



ART	BARCODE	ST.	PREZZO
05 32 70	8004537532708	H	20,50

CEPPO COLTELLI UNIVERSALE ROSSO EVA

UV1	UV2	IMBALLO
1	10	1/6 SP



8 0 0 4 5 3 7 5 3 2 7 0 8



ART	BARCODE	ST.	PREZZO
05 32 77	8004537532777		21,60

CEPPO COLTELLI UNIVERSALE NERO EVA

UV1	UV2	IMBALLO
1	6	1/6 SP



8 0 0 4 5 3 7 5 3 2 7 7 7



ART	BARCODE	ST.	PREZZO
05 32 60	4000270580222		23,50

CEPPO PER COLTELLI BAMBU FSC 10X10X23CM KESPER

UV1	UV2	IMBALLO
1	3	1/3 AL



4 0 0 0 2 7 0 5 8 0 2 2 2



ART	BARCODE	ST.	PREZZO
05 28 11	4004094129377		9,95

MEZZALUNA 'UNO' PP/ACCIAIO INOSSIDABILE WESTMARK

UV1	UV2	IMBALLO
1	4	1/4/24 CD



4 0 0 4 0 9 4 1 2 9 3 7 7



ART	BARCODE	ST.	PREZZO
05 28 12	4004094129476		16,50

MEZZALUNA DOPPIA LAMA 'DUE' PP/ACCIAIO INOSSIDABILE WESTMARK

UV1	UV2	IMBALLO
1	4	1/4/24 CD



4 0 0 4 0 9 4 1 2 9 4 7 6



ART	BARCODE	ST.	PREZZO
05 32 16	8004537532166		3,25

COLTELLO TAGLIACASTAGNE EVA

UV1	UV2	IMBALLO
1	12	1/12/144 SC



8 0 0 4 5 3 7 5 3 2 1 6 6



ART	BARCODE	ST.	PREZZO
05 32 17	8004537532173		2,65

COLTELLO TAGLIACASTAGNE SFUSO EVA

UV1	UV2	IMBALLO
12	60	1/12/144 BK



8 0 0 4 5 3 7 5 3 2 1 7 3



ART	BARCODE	ST.	PREZZO
04 13 46	4004094312069		8,45

AFFETTATORE ONDULATO 'GARNETTA' PA/INOX WESTMARK

UV1	UV2	IMBALLO
1	5	1/5/40 HB



4 0 0 4 0 9 4 3 1 2 0 6 9



ART	BARCODE	ST.	PREZZO
05 03 82	8008636115428		4,90

COLTELLO TAGLIAGRANA GRANDE GHIDINI CIPRIANO

UV1	UV2	IMBALLO
1	12	1/12/72 CD



8 0 0 8 6 3 6 1 1 5 4 2 8



ART	BARCODE	ST.	PREZZO
05 03 81	8008636114421		4,40

COLTELLO TAGLIAGRANA PICCOLO GHIDINI CIPRIANO

UV1	UV2	IMBALLO
1	12	1/12/72 CD



8 0 0 8 6 3 6 1 1 4 4 2 1



ART	BARCODE	ST.	PREZZO
04 51 47	4004094135675		5,85

COLTELLO PER FORMAGGI 'MASTER LINE' 25CM WESTMARK

UV1	UV2	IMBALLO
1	3	1/3/24 CD



4 0 0 4 0 9 4 1 3 5 6 7 5



ART	BARCODE	ST.	PREZZO
07 02 14	8004537702149		18,70

TAGLIA FORMAGGIO CIRCOLARE LEGNO RUBBERWOOD 22CM EVA

UV1	UV2	IMBALLO
1	4	1/12 PB



8 0 0 4 5 3 7 7 0 2 1 4 9



ART	BARCODE	ST.	PREZZO
05 28 03	8004537528039		10,50

TRINCIAPOLLO 'EXCLUSIVE' ACCIAIO INOSSIDABILE 25CM EVA

UV1	UV2	IMBALLO
1	12	1/12/72 PH



8 0 0 4 5 3 7 5 2 8 0 3 9



ART	BARCODE	ST.	PREZZO
05 28 04	4004094137280		13,30

TRINCIAPOLLI INOX/TPE 24CM WESTMARK

UV1	UV2	IMBALLO
1	6	1/6/48 DC



4 0 0 4 0 9 4 1 3 7 2 8 0



ART	BARCODE	ST.	PREZZO
05 46 28	8004537546286		2,40

FORBICE UNIVERSALE/CUCINA 20CM EVA

UV1	UV2	IMBALLO
1	12	1/12/72 BC



8 0 0 4 5 3 7 5 4 6 2 8 6



ART	BARCODE	ST.	PREZZO
05 46 33	8004537546330		2,50

FORBICE DA CUCINA MULTIUSO EVA

UV1	UV2	IMBALLO
1	12	1/12/72 CD



8 0 0 4 5 3 7 5 4 6 3 3 0



ART	BARCODE	ST.	PREZZO
05 46 31	8004537546316		6,50

SET 4 FORBICI MULTIUSO COLORI ASSORTITI EVA

UV1	UV2	IMBALLO
1	10	1/10/20 WB



8 0 0 4 5 3 7 5 4 6 3 1 6



ART	BARCODE	ST.	PREZZO
05 46 30	8004537546309		4,50

3 FORBICI DA CUCINA 13/16/19,5 CM EVA

UV1	UV2	IMBALLO
1	12	1/12/24 DC



8 0 0 4 5 3 7 5 4 6 3 0 9



ART	BARCODE	ST.	PREZZO
05 46 25	8004537546255		2,15

FORBICE HOBBY 14CM EVA

UV1	UV2	IMBALLO
1	12	1/12/144 CD



8 0 0 4 5 3 7 5 4 6 2 5 5



ART	BARCODE	ST.	PREZZO
05 46 24	8004537546248		2,05

FORBICE MULTIUSO 19,5CM EVA

UV1	UV2	IMBALLO
1	12	1/12/72 CD



8 0 0 4 5 3 7 5 4 6 2 4 8



ART	BARCODE	ST.	PREZZO
05 46 23	8004537546231		2,60

FORBICE MULTIUSO 21CM EVA

UV1	UV2	IMBALLO
1	12	1/12/72 CD



8 0 0 4 5 3 7 5 4 6 2 3 1



ART	BARCODE	ST.	PREZZO
05 46 20	8004537546200		3,30

FORBICE SARTA 24,5CM EVA

UV1	UV2	IMBALLO
1	12	1/12/72 CD



8 0 0 4 5 3 7 5 4 6 2 0 0



ART	BARCODE	ST.	PREZZO
04 13 12	4004094511066		14,90

AFFETTA MELE 'DIVISOREX' AL/ACCIAIO INOSSIDABILE WESTMARK

UV1	UV2	IMBALLO
1	5	1/5/35 HB



4 0 0 4 0 9 4 5 1 1 0 6 6



ART	BARCODE	ST.	PREZZO
02 17 12	8004537217124		5,20

TAGLIA MELE ALLUMINIO GRIGIO EVA

UV1	UV2	IMBALLO
1	6	1/6/24 CD



8 0 0 4 5 3 7 2 1 7 1 2 4



ART	BARCODE	ST.	PREZZO
02 17 14	4004094516276		7,25

AFFETTA MELE MANICI VERDI ABS/ACCIAIO INOSSIDABILE WESTMARK

UV1	UV2	IMBALLO
1	6	1/6/36 CD



4 0 0 4 0 9 4 5 1 6 2 7 6



ART	BARCODE	ST.	PREZZO
02 17 17	4004094516573	A	11,90

AFFETTAFRUTTA 'UNIVERSAL' ABS/ACCIAIO INOSSIDABILE WESTMARK

UV1	UV2	IMBALLO
1	6	1/6/48 CD



4 0 0 4 0 9 4 5 1 6 5 7 3



ART	BARCODE	ST.	PREZZO
02 17 10	4004094516078	A	18,90

AFFETTA MELONE 'JUMBO' ABS/ACCIAIO INOSSIDABILE WESTMARK

UV1	UV2	IMBALLO
1	6	1/3/12 CD



4 0 0 4 0 9 4 5 1 6 0 7 8



ART	BARCODE	ST.	PREZZO
02 17 11	8004537217117	H	12,60

TAGLIAMELONE+PROTEGGI-LAMA ABS/ACCIAIO INOSSIDABILE EVA

UV1	UV2	IMBALLO
1	6	1/3/12 SL



8 0 0 4 5 3 7 2 1 7 1 1 7



ART	BARCODE	ST.	PREZZO
02 17 21	4004094515866		7,90

TAGLIA-ANGURIA "HOOK" SILICONE/ACCIAIO INOSSIDABILE WESTMARK

UV1	UV2	IMBALLO
1	4	1/4/24 HB



4 0 0 4 0 9 4 5 1 5 8 6 6



ART	BARCODE	ST.	PREZZO
02 17 09	7611264506240	A	14,25

TAGLIA AVOCADO ACCIAIO INOX 18/10 'AVO' MOHA

UV1	UV2	IMBALLO
1	12	1/12/144 HB



7 6 1 1 2 6 4 5 0 6 2 4 0



ART	BARCODE	ST.	PREZZO
02 17 20	4004094517488		6,10

AFFETTA-FRAGOLE WESTMARK

UV1	UV2	IMBALLO
1	3	1/3/24 BC



4 0 0 4 0 9 4 5 1 7 4 8 8



ART	BARCODE	ST.	PREZZO
02 17 05	8004537217056		7,80

TAGLIA-ANANAS ACCIAIO INOSSIDABILE 18/8 EVA

UV1	UV2	IMBALLO
1	8	1/24 PB



8 0 0 4 5 3 7 2 1 7 0 5 6



ART	BARCODE	ST.	PREZZO
02 17 07	4004094516962	A	18,50

TAGLIA ANANAS PP/ACCIAIO INOSSIDABILE WESTMARK

UV1	UV2	IMBALLO
1	3	1/3/24 PB



4 0 0 4 0 9 4 5 1 6 9 6 2



ART	BARCODE	ST.	PREZZO
02 17 06	4004094516771		4,50

TAGLIA ANANAS ABS/PP WESTMARK

UV1	UV2	IMBALLO
1	10	1/10 CD



4 0 0 4 0 9 4 5 1 6 7 7 1



ART	BARCODE	ST.	PREZZO
04 18 12	4004094108082		2,30

FORAUOVO PS/ACCIAIO INOSSIDABILE Ø 4CM WESTMARK

UV1	UV2	IMBALLO
1	10	1/5/100 BC



4 0 0 4 0 9 4 1 0 8 0 8 2



ART	BARCODE	ST.	PREZZO
04 13 02	4004094108983		8,30

TAGLIA GUSCIO UOVO PE/ACCIAIO INOSSIDABILE WESTMARK

UV1	UV2	IMBALLO
1	6	1/6/48 BC



4 0 0 4 0 9 4 1 0 8 9 8 3



ART	BARCODE	ST.	PREZZO
04 13 03	4004094106064		15,20

TAGLIA UOVO 'COLUMBUS' ALLUMINIO/ACCIAIO INOSSID. WESTMARK

UV1	UV2	IMBALLO
1	5	1/5/25 HB



4 0 0 4 0 9 4 1 0 6 0 6 4



ART	BARCODE	ST.	PREZZO
04 18 21*	8004537418217	H	5,50

TAGLIAUOVA A SPICCHI ALLUMINIO GRIGIO EVA

UV1	UV2	IMBALLO
1	6	1/6/36 CD



8 0 0 4 5 3 7 4 1 8 2 1 7



ART	BARCODE	ST.	PREZZO
04 13 06	4004094104268		19,70

TAGLIA UOVA MAXIMUS ALL/ACCIAIO INOSSIDABILE 16X9CM WESTMARK

UV1	UV2	IMBALLO
1	10	1/5/20 HB



4 0 0 4 0 9 4 1 0 4 2 6 8



ART	BARCODE	ST.	PREZZO
04 13 05*	4004094102066		12,90

TAGLIA UOVO 'DUPLIX' ALLUMINIO/ACCIAIO INOSSIDABILE WESTMARK

UV1	UV2	IMBALLO
1	5	1/5/50 HB



4 0 0 4 0 9 4 1 0 2 0 6 6



ART	BARCODE	ST.	PREZZO
04 18 22*	8004537418224		7,25

TAGLIAUOVA ALLUMINIO GRIGIO EVA

UV1	UV2	IMBALLO
1	6	1/6/48 CD



8 0 0 4 5 3 7 4 1 8 2 2 4



ART	BARCODE	ST.	PREZZO
04 18 26	8004537418262		2,35

TAGLIAUOVA PLASTICA/ACCIAIO INOSSIDABILE EVA

UV1	UV2	IMBALLO
1	12	1/12/96 BC



8 0 0 4 5 3 7 4 1 8 2 6 2



ART	BARCODE	ST.	PREZZO
04 18 25	8004537418255		4,60

TAGLIAUOVA COMBI ABS/ACCIAIO INOSSIDABILE EVA

UV1	UV2	IMBALLO
1	12	1/12/72 CD



8 0 0 4 5 3 7 4 1 8 2 5 5



ART	BARCODE	ST.	PREZZO
04 13 36	4004094517068	A	17,70

TAGLIA FUNGHI 'CHAMPION' ALLUMINIO/ACCIAIO INOSSID. WESTMARK

UV1	UV2	IMBALLO
1	5	1/5/45 HB



4 0 0 4 0 9 4 5 1 7 0 6 8



ART	BARCODE	ST.	PREZZO
04 13 43	4004094608063		15,75

TAGLIAPATATE/MOZZARELLA 'RONDEX' ALLUMINIO/INOX WESTMARK

UV1	UV2	IMBALLO
1	5	1/5/30 CD



4 0 0 4 0 9 4 6 0 8 0 6 3



ART	BARCODE	ST.	PREZZO
04 17 78	4004094116469		7,40

AFFETTA MOZZARELLA ABS/ACCIAIO INOSSIDABILE WESTMARK

UV1	UV2	IMBALLO
1	6	1/6/48 HB



4 0 0 4 0 9 4 1 1 6 4 6 9



ART	BARCODE	ST.	PREZZO
04 06 29	8014405006989		10,50

TAGLIA-PUNTARELLE IN LEGNO DI FAGGIO 10X10 CM

UV1	UV2	IMBALLO
1	6	1/48 PH



8 0 1 4 4 0 5 0 0 6 9 8 9



ART	BARCODE	ST.	PREZZO
02 11 05	8004537211054		30,10

TRANCIAPATATE 3 LAME ACCIAIO INOSSIDABILE EVA

UV1	UV2	IMBALLO
1	6	1/12 PB



8 0 0 4 5 3 7 2 1 1 0 5 4



ART	BARCODE	ST.	PREZZO
02 11 02	8004537211023		13,00

TRANCIAPATATE ABS 9X9CM EVA

UV1	UV2	IMBALLO
1	12	1/12/36 PB



8 0 0 4 5 3 7 2 1 1 0 2 3



ART	BARCODE	ST.	PREZZO
02 11 03	4004094118067		31,50

TRANCIAPATATE 3 LAME ABS/ACCIAIO WESTMARK

UV1	UV2	IMBALLO
1	6	1/3/24 PB



4 0 0 4 0 9 4 1 1 8 0 6 7



ART	BARCODE	ST.	PREZZO
04 06 26	4019889135211		34,50

TAGLIAVERDURE A DADI/STRISCIE 'COMPACT DICER' 2 LAME LURCH

UV1	UV2	IMBALLO
1	6	1/6 PB



4 0 1 9 8 8 9 1 3 5 2 1 1



ART	BARCODE	ST.	PREZZO
02 18 39	4004094118265	A	38,50

TAGLIA FAGIOLI ALLUMINIO/ACCIAIO INOSSIDABILE WESTMARK

UV1	UV2	IMBALLO
1	2	1/5 PB



4 0 0 4 0 9 4 1 1 8 2 6 5



ART	BARCODE	ST.	PREZZO
02 18 25	8004537218251		7,70

TRITAPREZZEMOLO ACCIAIO INOSSIDABILE EVA

UV1	UV2	IMBALLO
1	12	1/12/48 BC



8 0 0 4 5 3 7 2 1 8 2 5 1



ART	BARCODE	ST.	PREZZO
02 18 28	4004094117664	A	18,25

TRITAERBE AROMATICHE ACCIAIO INOSSIDABILE WESTMARK

UV1	UV2	IMBALLO
1	6	1/6/24 PB



4 0 0 4 0 9 4 1 1 7 6 6 4



ART	BARCODE	ST.	PREZZO
02 18 58	7611264150191		39,90

TRITATUTTO RAPIDO 'SPEEDY MAX' 0,7L MOHA

UV1	UV2	IMBALLO
1	6	1/6/24 PB



7 6 1 1 2 6 4 1 5 0 1 9 1



ART	BARCODE	ST.	PREZZO
02 18 61	4019889135235		29,90

TRITATUTTO RAPIDO 'MULTI CHOPPER' Ø 14 CM LURCH

UV1	UV2	IMBALLO
1	6	1/6/24 PB



4 0 1 9 8 8 9 1 3 5 2 3 5



ART	BARCODE	ST.	PREZZO
02 18 59	7611264150290		12,90

TRITA SPEZIE/AGLIO/ERBE MINI 'AROMATICO' Ø 10 CM MOHA

UV1	UV2	IMBALLO
1	6	1/6/36 HB



7 6 1 1 2 6 4 1 5 0 2 9 0



ART	BARCODE	ST.	PREZZO
02 18 23	4004094106866		13,60

TRITAERBE AROMATICHE 'SCHNEIDFIX' WESTMARK

UV1	UV2	IMBALLO
1	3	1/3/24 HB



4 0 0 4 0 9 4 1 0 6 8 6 6



ART	BARCODE	ST.	PREZZO
02 10 22	9002655009804		15,70

TRITACIPOLLA 'HACKER 80' BIANCO Ø8CM KELOMAT

UV1	UV2	IMBALLO
1	12	1/12/48 HB



9 0 0 2 6 5 5 0 0 9 8 0 4



ART	BARCODE	ST.	PREZZO
04 12 04	8004537412048		14,30

MORTAIO IN MARMO Ø11 CM EVA

UV1	UV2	IMBALLO
1	12	1/12 PB



8 0 0 4 5 3 7 4 1 2 0 4 8



ART	BARCODE	ST.	PREZZO
04 12 06	8004537412062		22,60

MORTAIO IN MARMO Ø•13 CM EVA

UV1	UV2	IMBALLO
1	6	1/6 PB



8 0 0 4 5 3 7 4 1 2 0 6 2



ART	BARCODE	ST.	PREZZO
04 12 07*	8004537412079	H	15,50

MORTAIO MARMO PESTELLO GRANDE Ø10CM EVA

UV1	UV2	IMBALLO
1	12	1/12 PB



8 0 0 4 5 3 7 4 1 2 0 7 9



ART	BARCODE	ST.	PREZZO
04 15 96	8004537415964		35,50

MORTAIO MARMO Ø17CM EVA

UV1	UV2	IMBALLO
1	4	1/4 PB



8 0 0 4 5 3 7 4 1 5 9 6 4



ART	BARCODE	ST.	PREZZO
04 11 98	4000270715013		19,90

MORTAIO GRANITO Ø16X8,5 CM KESPER

UV1	UV2	IMBALLO
1	4	1/4 WB



4 0 0 0 2 7 0 7 1 5 0 1 3



ART	BARCODE	ST.	PREZZO
04 11 99	4000270715020		19,00

MORTAIO GRANITO Ø18X12 CM KESPER

UV1	UV2	IMBALLO
1	4	1/4 WB



4 0 0 0 2 7 0 7 1 5 0 2 0



ART	BARCODE	ST.	PREZZO
04 12 01	4000270715037		17,50

MORTAIO GRANITO Ø12,5X9-10 CM KESPER

UV1	UV2	IMBALLO
1	4	1/4 WB



4 0 0 0 2 7 0 7 1 5 0 3 7



ART	BARCODE	ST.	PREZZO
04 32 35	4000270381607		16,50

TAGLIERE MARRONE FIBRA DI LEGNO FSC 27X20X0.6 CM KESPER

UV1	UV2	IMBALLO
1	5	1/5/20 SL



4 0 0 0 2 7 0 3 8 1 6 0 7



ART	BARCODE	ST.	PREZZO
04 32 36	4000270381614		29,70

TAGLIERE MARRONE FIBRA DI LEGNO FSC 40X30X0.6 CM KESPER

UV1	UV2	IMBALLO
1	5	1/5 SL



4 0 0 0 2 7 0 3 8 1 6 1 4



ART	BARCODE	ST.	PREZZO
04 32 38	4000270381805		16,80

TAGLIERE NERO FIBRA DI LEGNO FSC 30X22X0.6 CM KESPER

UV1	UV2	IMBALLO
1	5	1/5/20 SL



4 0 0 0 2 7 0 3 8 1 8 0 5



ART	BARCODE	ST.	PREZZO
04 32 39	4000270381812		25,50

TAGLIERE NERO FIBRA DI LEGNO FSC
38X28X0.6 CM KESPER

UV1	UV2	IMBALLO
1	5	1/5/20 SL



4 0 0 0 2 7 0 3 8 1 8 1 2



ART	BARCODE	ST.	PREZZO
04 32 40	4000270381829		45,50

TAGLIERE NERO FIBRA DI LEGNO FSC
48X38X0.6 CM KESPER

UV1	UV2	IMBALLO
1	5	1/5 SL



4 0 0 0 2 7 0 3 8 1 8 2 9



ART	BARCODE	ST.	PREZZO
04 04 61	4004094000638		9,20

TAGLIERE NERO BORDO ROSSO PP/TPE
29X20 CM WESTMARK

UV1	UV2	IMBALLO
1	4	1/4/12 SP



4 0 0 4 0 9 4 0 0 0 6 3 8



ART	BARCODE	ST.	PREZZO
04 04 62	4004094000645		15,90

TAGLIERE NERO BORDO ROSSO PP/TPE
37X26 CM WESTMARK

UV1	UV2	IMBALLO
1	4	1/4/12 SP



4 0 0 4 0 9 4 0 0 0 6 4 5



ART	BARCODE	ST.	PREZZO
04 04 63	4004094000652		25,40

TAGLIERE NERO BORDO ROSSO PP/TPE
44,5X30 CM WESTMARK

UV1	UV2	IMBALLO
1	4	1/4/12 SP



4 0 0 4 0 9 4 0 0 0 6 5 2



ART	BARCODE	ST.	PREZZO
04 04 23	7611264100615	H	8,10

TAGLIERE ACRILICO 20X15CM MOHA

UV1	UV2	IMBALLO
1	6	1/48 SP



7 6 1 1 2 6 4 1 0 0 6 1 5



ART	BARCODE	ST.	PREZZO
04 04 31	8004537404319		4,75

TAGLIERE RETTANGOLARE PE BIANCO
254x150x9MM EVA

UV1	UV2	IMBALLO
1	10	1/60 SP



8 0 0 4 5 3 7 4 0 4 3 1 9



ART	BARCODE	ST.	PREZZO
04 04 32	8004537404326		8,30

TAGLIERE RETTANGOLARE PE BIANCO
30x20x1 CM EVA

UV1	UV2	IMBALLO
1	10	1/30 SP



8 0 0 4 5 3 7 4 0 4 3 2 6



ART	BARCODE	ST.	PREZZO
04 04 33	8004537404333		10,95

TAGLIERE RETTANGOLARE PE BIANCO
35x24,7x1 CM EVA

UV1	UV2	IMBALLO
1	5	1/20 SP



8 0 0 4 5 3 7 4 0 4 3 3 3



ART	BARCODE	ST.	PREZZO
04 04 35	8004537404357		13,90

TAGLIERE CON SCANALATURA PE
BIANCO 40x30x1 CM EVA

UV1	UV2	IMBALLO
1	5	1/15 SP



8 0 0 4 5 3 7 4 0 4 3 5 7



ART	BARCODE	ST.	PREZZO
04 04 36	8004537404364		32,50

TAGLIERE/SPIANATOIA PE BIANCO
45x60x1,2 CM EVA

UV1	UV2	IMBALLO
1	3	1/6 SP



8 0 0 4 5 3 7 4 0 4 3 6 4



ART	BARCODE	ST.	PREZZO
04 04 38	8004537404388		37,50

TAGLIERE MACELLAIO PE BIANCO
50X30CM

UV1	UV2	IMBALLO
1	4	1/4 SP



8 0 0 4 5 3 7 4 0 4 3 8 8



ART	BARCODE	ST.	PREZZO
04 04 39	8004537404395		59,50

TAGLIERE MACELLAIO PE BIANCO
60X40CM

UV1	UV2	IMBALLO
1	4	1/4 SP



8 0 0 4 5 3 7 4 0 4 3 9 5



ART	BARCODE	ST.	PREZZO
04 04 51	4000270889387		9,90

3 TAGLIERI COLORATI 25/30/35CM
KESPER

UV1	UV2	IMBALLO
1	10	1/10 SP



4 0 0 0 2 7 0 8 8 9 3 8 7



ART	BARCODE	ST.	PREZZO
04 04 52	4004094117756		8,40

2 TAGLIERE FLESSIBILE PP/PE 38X30,5
CM WESTMARK

UV1	UV2	IMBALLO
1	6	1/6/48 PG



4 0 0 4 0 9 4 1 1 7 7 5 6



ART	BARCODE	ST.	PREZZO
04 04 53	4000270301506		29,80

TAGLIERE HACCP PE GIALLO 53X32,5CM
KESPER

UV1	UV2	IMBALLO
1	5	1/5 SP



4 0 0 0 2 7 0 3 0 1 5 0 6



ART	BARCODE	ST.	PREZZO
04 04 54	4000270301513		29,80

TAGLIERE HACCP PE BIANCO 53X32,5CM
KESPER

UV1	UV2	IMBALLO
1	5	1/5 SP



4 0 0 0 2 7 0 3 0 1 5 1 3



ART	BARCODE	ST.	PREZZO
04 04 55	4000270301520		29,80

TAGLIERE HACCP PE BLU 53X32,5CM
KESPER

UV1	UV2	IMBALLO
1	5	1/5 SP



4 0 0 0 2 7 0 3 0 1 5 2 0



ART	BARCODE	ST.	PREZZO
04 04 56	4000270301537		29,80

TAGLIERE HACCP PE ROSSO 53X32,5CM
KESPER

UV1	UV2	IMBALLO
1	5	1/5 SP



4 0 0 0 2 7 0 3 0 1 5 3 7



ART	BARCODE	ST.	PREZZO
04 04 57	4000270301544		29,80

TAGLIERE HACCP PE VERDE 53X32,5CM
KESPER

UV1	UV2	IMBALLO
1	5	1/5 SP



4 0 0 0 2 7 0 3 0 1 5 4 4



ART	BARCODE	ST.	PREZZO
04 04 01	4000270307546		4,50

TAGLIERE PP ANTISCIVOLO 25X15X1 CM
KESPER

UV1	UV2	IMBALLO
1	5	1/5/20 SP



4 0 0 0 2 7 0 3 0 7 5 4 6



ART	BARCODE	ST.	PREZZO
04 04 02	4000270307508		6,75

TAGLIERE PP ANTISCIVOLO 31.5X20X1
CM KESPER

UV1	UV2	IMBALLO
1	5	1/5 SP



4 0 0 0 2 7 0 3 0 7 5 0 8



ART	BARCODE	ST.	PREZZO
04 04 03	4000270307515		10,90

TAGLIERE PP ANTISCIVOLO 40X24X1 CM
KESPER

UV1	UV2	IMBALLO
1	5	1/5/20 SP



4 0 0 0 2 7 0 3 0 7 5 1 5



ART	BARCODE	ST.	PREZZO
04 04 04	4000270307560		15,50

TAGLIERE PP ANTISCIVOLO 43X30X0.7
CM KESPER

UV1	UV2	IMBALLO
1	5	1/5 SP



4 0 0 0 2 7 0 3 0 7 5 6 0



ART	BARCODE	ST.	PREZZO
04 04 45	7610859151711	A	5,70

TAGLIERE ANTISCIVOLO 'CARUBA' PP
25X15X0,9 CM ROTHO

UV1	UV2	IMBALLO
1	10	1/10 AL



7 6 1 0 8 5 9 1 5 1 7 1 1



ART	BARCODE	ST.	PREZZO
04 04 68	4000270305870		3,00

TAGLIERE ANTISCIVOLO FLEXIBILE
VERDE 30X21 CM KESPER

UV1	UV2	IMBALLO
1	10	1/10/120 PG



4 0 0 0 2 7 0 3 0 5 8 7 0



ART	BARCODE	ST.	PREZZO
04 04 70	4000270305979		3,20

TAGLIERE ANTISCIVOLO FLEXIBILE
VERDE 34X25CM KESPER

UV1	UV2	IMBALLO
1	10	1/10/100 PG



4 0 0 0 2 7 0 3 0 5 9 7 9



ART	BARCODE	ST.	PREZZO
04 04 71	4000270305986		3,20

TAGLIERE ANTISCIVOLO FLEXIBILE
ROSSO 34X25 CM KESPER

UV1	UV2	IMBALLO
1	10	1/10/100 PG



4 0 0 0 2 7 0 3 0 5 9 8 6



ART	BARCODE	ST.	PREZZO
04 04 72	4000270305474		4,40

TAGLIERE ANTISCIVOLO FLEXIBILE
VERDE 38X29CM KESPER

UV1	UV2	IMBALLO
1	10	1/10/50 AL



4 0 0 0 2 7 0 3 0 5 4 7 4



ART	BARCODE	ST.	PREZZO
04 33 72	4000270583100		2,50

TAGLIERE BAMBÙ FSC + FORO
22,5X14,5X0,8CM KESPER

UV1	UV2	IMBALLO
1	10	1/5/30 SL



4 0 0 0 2 7 0 5 8 3 1 0 0



ART	BARCODE	ST.	PREZZO
04 33 73	4000270583209		4,70

TAGLIERE BAMBÙ FSC+FORO
30X21X0,8CM KESPER

UV1	UV2	IMBALLO
1	10	1/5/30 SL



4 0 0 0 2 7 0 5 8 3 2 0 9



ART	BARCODE	ST.	PREZZO
04 33 74	4000270583308		6,90

TAGLIERE BAMBÙ FSC + FORO
35X24X0,8CM KESPER

UV1	UV2	IMBALLO
1	10	1/5/30 SL



4 0 0 0 2 7 0 5 8 3 3 0 8



ART	BARCODE	ST.	PREZZO
04 34 71	4000270581090		2,50

TAGLIERE BAMBÙ FSC 23X15X1,0 CM
KESPER

UV1	UV2	IMBALLO
1	10	1/5/30 SL



4 0 0 0 2 7 0 5 8 1 0 9 0



ART	BARCODE	ST.	PREZZO
04 34 61	4000270581106		6,40

TAGLIERE BAMBÙ FSC 30X20X1,6 CM
KESPER

UV1	UV2	IMBALLO
1	10	1/5 SL



4 0 0 0 2 7 0 5 8 1 1 0 6



ART	BARCODE	ST.	PREZZO
04 34 62	4000270581113		12,20

TAGLIERE BAMBÙ FSC 40X30X1,6 CM
KESPER

UV1	UV2	IMBALLO
1	5	1/5 SL



4 0 0 0 2 7 0 5 8 1 1 1 3



ART	BARCODE	ST.	PREZZO
04 33 91	4000270581502		21,50

TAGLIERE BAMBÙ FSC+MANICI
ALLUMINIO 38x28x4CM KESPER

UV1	UV2	IMBALLO
1	3	1/3 SP



4 0 0 0 2 7 0 5 8 1 5 0 2



ART	BARCODE	ST.	PREZZO
04 34 58	4000270581816		16,50

**TAGLIERE MOSAICO BAMBU FSC
36X24X3 CM KESPER**

UV1	UV2	IMBALLO
1	3	1/3 SP



4 0 0 0 2 7 0 5 8 1 8 1 6



ART	BARCODE	ST.	PREZZO
04 33 86	4000270581205		7,90

**TAGLIERE BAMBU FSC 33X23X1,6 CM
KESPER**

UV1	UV2	IMBALLO
1	5	1/5/20 SL



4 0 0 0 2 7 0 5 8 1 2 0 5



ART	BARCODE	ST.	PREZZO
04 33 96	4000270581250		34,50

**TAGLIERE LEGNO
MASSICIO+SUPERFICIE BAMBU' FSC
50X40X5 KESPER**

UV1	UV2	IMBALLO
1	2	1/2 SL



4 0 0 0 2 7 0 5 8 1 2 5 0



ART	BARCODE	ST.	PREZZO
04 34 55	4000270581052		15,90

**TAGLIERE BAMBU FSC PER PANE
42x28x2CM KESPER**

UV1	UV2	IMBALLO
1	5	1/5 SP



4 0 0 0 2 7 0 5 8 1 0 5 2



ART	BARCODE	ST.	PREZZO
04 33 52	4000270680038		7,50

**3 TAGLIERI RETTANGOLARI LEGNO
FAGGIO FSC 23X15CM EVA**

UV1	UV2	IMBALLO
1	10	1/5 SL



4 0 0 0 2 7 0 6 8 0 0 3 8



ART	BARCODE	ST.	PREZZO
04 33 56	4000270680137	A	5,90

**TAGLIERE+MANICO LEGNO DI FAGGIO
FSC 35X16 CM**

UV1	UV2	IMBALLO
1	5	1/5 SL



4 0 0 0 2 7 0 6 8 0 1 3 7



ART	BARCODE	ST.	PREZZO
04 32 29	4000270854446		8,90

**TAGLIERE ROTONDO FAGGIO FSC
Ø30CM KESPER**

UV1	UV2	IMBALLO
1	6	1/6 SP



4 0 0 0 2 7 0 8 5 4 4 4 6



ART	BARCODE	ST.	PREZZO
04 33 30	4000270281518		34,50

**TAGLIERE ACACIA MOSAICO FSC
42X30X4CM KESPER**

UV1	UV2	IMBALLO
1	3	1/3 SL



4 0 0 0 2 7 0 2 8 1 5 1 8



ART	BARCODE	ST.	PREZZO
04 33 33	4000270281020		21,50

**TAGLIERE ACACIA FSC 45X27X3CM
KESPER**

UV1	UV2	IMBALLO
1	3	1/3 SL



4 0 0 0 2 7 0 2 8 1 0 2 0



ART	BARCODE	ST.	PREZZO
04 33 35	4000270284007		2,40

**TAGLIERE LEGNO DI ACACIA FSC LISCIO
23X15CM KESPER**

UV1	UV2	IMBALLO
1	30	1/5/30 SL



4 0 0 0 2 7 0 2 8 4 0 0 7



ART	BARCODE	ST.	PREZZO
04 33 36	4000270281808		7,20

**TAGLIERE LEGNO DI ACACIA FSC
32X21CM KESPER**

UV1	UV2	IMBALLO
1	5	1/5 SL



4 0 0 0 2 7 0 2 8 1 8 0 8



ART	BARCODE	ST.	PREZZO
04 33 37	4000270281815		10,50

**TAGLIERE LEGNO DI ACACIA FSC LISCIO
40X26CM KESPER**

UV1	UV2	IMBALLO
1	5	1/5 SL



4 0 0 0 2 7 0 2 8 1 8 1 5



ART	BARCODE	ST.	PREZZO
04 33 38	4000270281907		6,00

TAGLIERE LEGNO DI ACACIA FSC+MANICO 29X14CM KESPER

UV1	UV2	IMBALLO
1	5	1/5 SL



4 0 0 0 2 7 0 2 8 1 9 0 7



ART	BARCODE	ST.	PREZZO
04 33 40	4000270281921		12,30

TAGLIERE LEGNO DI ACACIA FSC+MANICO 45X22CM KESPER

UV1	UV2	IMBALLO
1	5	1/5 SL



4 0 0 0 2 7 0 2 8 1 9 2 1



ART	BARCODE	ST.	PREZZO
04 33 39	4000270281914		8,10

TAGLIERE LEGNO DI ACACIA FSC+MANICO 35X18CM KESPER

UV1	UV2	IMBALLO
1	5	1/5 SL



4 0 0 0 2 7 0 2 8 1 9 1 4



ART	BARCODE	ST.	PREZZO
04 33 08	4000270284038		6,60

3 TAGLIERI RETTANGOLARI LEGNO ACACIA FSC 23X15CM

UV1	UV2	IMBALLO
1	5	1/5/20 SL



4 0 0 0 2 7 0 2 8 4 0 3 8



ART	BARCODE	ST.	PREZZO
04 33 28	4000270285004		6,40

TAGLIERE ACACIA FSC 38X14X1,5CM KESPER

UV1	UV2	IMBALLO
1	5	1/5 SL



4 0 0 0 2 7 0 2 8 5 0 0 4



ART	BARCODE	ST.	PREZZO
04 33 29	4000270285059		11,60

TAGLIERE ACACIA FSC 53X19X2 CM KESPER

UV1	UV2	IMBALLO
1	5	1/5 SL



4 0 0 0 2 7 0 2 8 5 0 5 9



ART	BARCODE	ST.	PREZZO
04 33 41	4000270286001		9,80

TAGLIERE ACACIA FSC 35X22X1,8CM KESPER

UV1	UV2	IMBALLO
1	5	1/5 SL



4 0 0 0 2 7 0 2 8 6 0 0 1



ART	BARCODE	ST.	PREZZO
04 33 42	4000270286018		10,90

TAGLIERE ACACIA FSC 37X23X1,8 CM KESPER

UV1	UV2	IMBALLO
1	5	1/5 SL



4 0 0 0 2 7 0 2 8 6 0 1 8



ART	BARCODE	ST.	PREZZO
04 33 43	4000270286025		11,90

TAGLIERE ACACIA FSC 40X24X1,8 CM KESPER

UV1	UV2	IMBALLO
1	5	1/5 SL



4 0 0 0 2 7 0 2 8 6 0 2 5



ART	BARCODE	ST.	PREZZO
04 33 21	4000270284700		12,50

TAGLIERE CON PIEDI ACACIA FSC 53X19X2 CM KESPER

UV1	UV2	IMBALLO
1	4	1/4 SL



4 0 0 0 2 7 0 2 8 4 7 0 0



ART	BARCODE	ST.	PREZZO
04 33 81	4000270585906		16,80

TAGLIERE/COPRIPIASTRA BAMBU FSC 54X28X4.3 CM KESPER

UV1	UV2	IMBALLO
1	4	1/4 SL



4 0 0 0 2 7 0 5 8 5 9 0 6



ART	BARCODE	ST.	PREZZO
04 33 22	4000270281938		15,50

TAGLIERE CON MANICO ACACIA FSC 55X25X1.8 CM KESPER

UV1	UV2	IMBALLO
1	5	1/5 SL



4 0 0 0 2 7 0 2 8 1 9 3 8



ART	BARCODE	ST.	PREZZO
04 33 23	4000270285066		13,50

TAGLIERE ACACIA FSC 38.5X27.5X1.8 CM KESPER

UV1	UV2	IMBALLO
1	5	1/5 SL



4 0 0 0 2 7 0 2 8 5 0 6 6



ART	BARCODE	ST.	PREZZO
04 33 24	4000270285073	A	17,50

TAGLIERE ACACIA FSC 46X33X1.8 CM KESPER

UV1	UV2	IMBALLO
1	5	1/5 SL



4 0 0 0 2 7 0 2 8 5 0 7 3



ART	BARCODE	ST.	PREZZO
04 33 25	4000270281051		19,50

TAGLIERE PER PANE LEGNO ACACIA FSC 47.5X32X2 CM KESPER

UV1	UV2	IMBALLO
1	5	1/5 SL



4 0 0 0 2 7 0 2 8 1 0 5 1



ART	BARCODE	ST.	PREZZO
04 33 26	4000270287008		24,50

TAGLIERE ACACIA FSC 38X28X3 CM KESPER

UV1	UV2	IMBALLO
1	3	1/3 SL



4 0 0 0 2 7 0 2 8 7 0 0 8



ART	BARCODE	ST.	PREZZO
04 33 34	4000270281037		18,50

TAGLIERE ACACIA FSC 45X27X3CM KESPER

UV1	UV2	IMBALLO
1	3	1/3 SL



4 0 0 0 2 7 0 2 8 1 0 3 7

**Grattugiare Affettare Sbucciare
Passare**



ART	BARCODE	ST.	PREZZO
02 16 32	4004094119286		5,40

SBUCCIA AGLIO 'PEEL FIX' SILICONE WESTMARK

UV1	UV2	IMBALLO
1	12	1/6/36 BC



4 0 0 4 0 9 4 1 1 9 2 8 6



ART	BARCODE	ST.	PREZZO
02 10 21	9002655009774		16,00

SPREMIAGLIO KELOMAT

UV1	UV2	IMBALLO
1	12	1/12/48 BC



9 0 0 2 6 5 5 0 0 9 7 7 4



ART	BARCODE	ST.	PREZZO
04 13 32*	4004094301063		8,10

SPREMIAGLIO 'BIOPRESS' ALLUMINIUM WESTMARK

UV1	UV2	IMBALLO
1	5	1/5/70 HB



4 0 0 4 0 9 4 3 0 1 0 6 3



ART	BARCODE	ST.	PREZZO
04 54 21	8004537454215		3,60

SPREMIAGLIO 'PRIMA BIANCO' EVA

UV1	UV2	IMBALLO
1	6	1/6/72 BC



8 0 0 4 5 3 7 4 5 4 2 1 5



ART	BARCODE	ST.	PREZZO
02 16 13	7611264306307		13,20

SPREMI AGLIO 'PELIKAN' ALLUMINIO MOHA

UV1	UV2	IMBALLO
1	12	1/12/96 HB



7 6 1 1 2 6 4 3 0 6 3 0 7



ART	BARCODE	ST.	PREZZO
02 16 15	7611264326190		16,20

SPREMI/PRESSA AGLIO 'AGLIO' NERO MOHA

UV1	UV2	IMBALLO
1	6	1/6/48 HB



7 6 1 1 2 6 4 3 2 6 1 9 0



ART	BARCODE	ST.	PREZZO
02 16 19	4004094300066	A	18,25

SPREMAGLIO MULTIUSO 'EXTRACTA' ALLUMINIO WESTMARK

UV1	UV2	IMBALLO
1	5	1/5/45 HB



4 0 0 4 0 9 4 3 0 0 0 6 6



ART	BARCODE	ST.	PREZZO
04 53 94	4004094283673		12,30

SPREMI-AGLIO 'GENTLE' PA 19,5 CM WESTMARK

UV1	UV2	IMBALLO
1	3	1/3/15 CD



4 0 0 4 0 9 4 2 8 3 6 7 3



ART	BARCODE	ST.	PREZZO
02 15 99	8014405005418		17,50

SCHIACCIAPASSATELLI ACCIAIO INOSSIDABILE 18/10

UV1	UV2	IMBALLO
1	6	1/30 PB



8 0 1 4 4 0 5 0 0 5 4 1 8



ART	BARCODE	ST.	PREZZO
02 16 10	8004537216103		20,90

SCHIACCIAPATATE ACCIAIO INOSSIDABILE 18/8 Ø8X29 CM EVA

UV1	UV2	IMBALLO
1	6	1/12 PB



8 0 0 4 5 3 7 2 1 6 1 0 3



ART	BARCODE	ST.	PREZZO
02 16 01	8004537216011		27,80

SCHIACCIAPATATE PROFI ACCIAIO INOSSIDABILE 30CM EVA

UV1	UV2	IMBALLO
1	6	1/6/24 PB



8 0 0 4 5 3 7 2 1 6 0 1 1



ART	BARCODE	ST.	PREZZO
02 16 03	8014405001472		9,95

SCHIACCIAPATATE ALLUMINIO CALDER

UV1	UV2	IMBALLO
1	5	1/30 PB



8 0 1 4 4 0 5 0 0 1 4 7 2



ART	BARCODE	ST.	PREZZO
02 16 12	8014405021470		9,95

SCHIACCIAPASSATELLI ALLUMINIO CALDER

UV1	UV2	IMBALLO
1	8	1/30 PB



ART	BARCODE	ST.	PREZZO
02 16 08	8004537216080		7,30

SCHIACCIAPATATE CROMATO EVA

UV1	UV2	IMBALLO
1	6	1/6/36 SL



ART	BARCODE	ST.	PREZZO
02 16 09	8004537216097		14,95

SCHIACCIAPATATE+PASSATELLI CROMATO EVA

UV1	UV2	IMBALLO
1	6	1/6/36 SL



ART	BARCODE	ST.	PREZZO
02 16 04	4004094611063		50,50

SCHIACCIAPATATE/SPÄTZLE ALLUMINIO RIVESTITO WESTMARK

UV1	UV2	IMBALLO
1	5	1/10 PB



ART	BARCODE	ST.	PREZZO
02 16 06	4004094611766		57,50

SCHIACCIAPATATE/SPÄTZLE 'QUADRO' ACCIAIO INOSSIDAB. WESTMARK

UV1	UV2	IMBALLO
1	3	1/3/12 PB



ART	BARCODE	ST.	PREZZO
02 16 07	4004094612473	A	21,50

SCHIACCIAPATATE ZINCATO WESTMARK

UV1	UV2	IMBALLO
1	5	1/5 SL



ART	BARCODE	ST.	PREZZO
04 13 81	4004094612770		10,40

SCHIACCIAPATATE ACCIAIO INOSSIDABILE WESTMARK

UV1	UV2	IMBALLO
1	5	1/5/20 CD



ART	BARCODE	ST.	PREZZO
02 16 00	7611264315095		21,00

SCHIACCIAPATATE/VERDURE 'KANGOU' MOHA

UV1	UV2	IMBALLO
1	6	1/6/24 HB



ART	BARCODE	ST.	PREZZO
02 15 07	8004537215076		12,95

PASSAMORE ACCIAIO INOSSIDABILE 18/8+PESTELLO LEGNO 20CM EVA

UV1	UV2	IMBALLO
1	6	1/6 HT



ART	BARCODE	ST.	PREZZO
02 15 16	8011126101085		17,50

PASSAVERDURE ACCIAIO INOSSIDABILE 20CM GNALI

UV1	UV2	IMBALLO
1	4	1/12 SL



ART	BARCODE	ST.	PREZZO
02 15 17	8011126101092		22,50

PASSAVERDURE ACCIAIO INOSSIDABILE 24CM GNALI

UV1	UV2	IMBALLO
1	4	1/12 SL



ART	BARCODE	ST.	PREZZO
02 15 04	4004094119569		67,50

PASSAVERDURE 'FINOLETTA' ACCIAIO INOSSIDABILE WESTMARK

UV1	UV2	IMBALLO
1	3	1/3/6 PB





ART	BARCODE	ST.	PREZZO
02 15 15	8004537215151		38,50

PASSAVERDURE ACCIAIO INOSSIDABILE CON 3 DISCHI Ø 20,5 CM EVA

UV1	UV2	IMBALLO
1	6	1/6 PB



8 0 0 4 5 3 7 2 1 5 1 5 1



ART	BARCODE	ST.	PREZZO
02 18 24	8004537218244		8,50

GRATTUGIA FORMAGGIO ACCIAIO INOSSIDABILE EVA

UV1	UV2	IMBALLO
1	12	1/12/48 BC



8 0 0 4 5 3 7 2 1 8 2 4 4



ART	BARCODE	ST.	PREZZO
02 10 23	4004094117268		16,50

GRATTUGIA A TAMBURIO 'TRIO' ABS/ACCIAIO INOSSIDABILE WESTMARK

UV1	UV2	IMBALLO
1	6	1/3/48 PB



4 0 0 4 0 9 4 1 1 7 2 6 8



ART	BARCODE	ST.	PREZZO
02 10 29	9002655009941		15,70

GRATTUGIA A TAMBURIO FORMAGGIO KELOMAT

UV1	UV2	IMBALLO
1	2	1/12/48 PB



9 0 0 2 6 5 5 0 0 9 9 4 1



ART	BARCODE	ST.	PREZZO
02 18 03	4004094976063		59,50

GRATTUGIA A TAMBURIO 4 RULLI ABS/ACCIAIO INOSSIDAB. WESTMARK

UV1	UV2	IMBALLO
1	2	1/4/12 PB



4 0 0 4 0 9 4 9 7 6 0 6 3



ART	BARCODE	ST.	PREZZO
02 18 04	7611264205204		12,50

GRATTUGIA A TAMBURIO 'EVOLUTION DRUM' BIANCA MOHA

UV1	UV2	IMBALLO
1	6	1/6/24 HB



7 6 1 1 2 6 4 2 0 5 2 0 4



ART	BARCODE	ST.	PREZZO
02 18 06	8004537218060		10,80

GRATTUGIA A RULLO ROSSA Ø8CM EVA

UV1	UV2	IMBALLO
1	5	1/20 PB



8 0 0 4 5 3 7 2 1 8 0 6 0



ART	BARCODE	ST.	PREZZO
02 18 10	8001895000405		9,90

GRATTUGIA FORMAGGIO PLASTICA

UV1	UV2	IMBALLO
1	12	1/60 HB



8 0 0 1 8 9 5 0 0 0 4 0 5



ART	BARCODE	ST.	PREZZO
02 18 12	8001603020558		29,25

GRATTUGIA DA TAVOLA ACCIAIO INOSSIDABILE GHIDINI

UV1	UV2	IMBALLO
1	12	1/12 HB



8 0 0 1 6 0 3 0 2 0 5 5 8



ART	BARCODE	ST.	PREZZO
02 18 13*	7611264200032	H	17,90

GRATTUGIA FORMAGGIO 'MOLINO' BIANCA MOHA

UV1	UV2	IMBALLO
1	6	1/6/48 HB



7 6 1 1 2 6 4 2 0 0 0 3 2



ART	BARCODE	ST.	PREZZO
02 18 14*	7611264216323	A	27,80

GRATTUGIA FORMAGGIO 'MOLINO' ACCIAIO INOSSIDABILE MOHA

UV1	UV2	IMBALLO
1	6	1/6/48 HB



7 6 1 1 2 6 4 2 1 6 3 2 3



ART	BARCODE	ST.	PREZZO
02 18 35*	7611264200018	H	13,50

MULINO PER BURRO 'PRESTO' BIANCO MOHA

UV1	UV2	IMBALLO
1	6	1/6/48 HB



7 6 1 1 2 6 4 2 0 0 0 1 8



ART	BARCODE	ST.	PREZZO
02 18 34	7611264200162	H	13,50

MULINO PER BURRO 'PRESTO' ROSSO MOHA

UV1	UV2	IMBALLO
1	6	1/6/48 HB



7 6 1 1 2 6 4 2 0 0 1 6 2



ART	BARCODE	ST.	PREZZO
02 18 36	7611264210017	H	21,50

MULINO PER BURRO 'PRESTO' INOX MOHA

UV1	UV2	IMBALLO
1	6	1/6/48 HB



7 6 1 1 2 6 4 2 1 0 0 1 7



ART	BARCODE	ST.	PREZZO
04 06 17	8002713000966		4,95

GRATTUGIA MELE VETRO 20 CM

UV1	UV2	IMBALLO
1	24	1/24 BK



8 0 0 2 7 1 3 0 0 0 9 6 6



ART	BARCODE	ST.	PREZZO
04 06 01	8010191005090		1,40

GRATTUGIA MIGNON ACCIAIO INOSSIDABILE 9CM

UV1	UV2	IMBALLO
1	6	1/6/600 BK



8 0 1 0 1 9 1 0 0 5 0 9 0



ART	BARCODE	ST.	PREZZO
04 06 02	8010191005168		2,25

GRATTUGIA DA TAVOLA ACCIAIO INOSSIDABILE 16CM BB&B

UV1	UV2	IMBALLO
1	6	1/6/240 BK



8 0 1 0 1 9 1 0 0 5 1 6 8



ART	BARCODE	ST.	PREZZO
04 06 42	4004094113574		11,30

GRATTUGIA A FORI LARGHI ACCIAIO INOSSIDABILE WESTMARK

UV1	UV2	IMBALLO
1	5	1/5/20 SL



4 0 0 4 0 9 4 1 1 3 5 7 4



ART	BARCODE	ST.	PREZZO
04 13 55	4004094141072		16,90

GRATTUGIA 'TECHNICUS SQUARE' FINE INOX 32X6,5 CM WESTMARK

UV1	UV2	IMBALLO
1	6	1/6/48 SL



4 0 0 4 0 9 4 1 4 1 0 7 2



ART	BARCODE	ST.	PREZZO
04 13 56	4004094141270		16,90

GRATTUGIA 'TECHNICUS SQUARE' MEDIA INOX 32X6,5 CM WESTMARK

UV1	UV2	IMBALLO
1	6	1/6/48 SL



4 0 0 4 0 9 4 1 4 1 2 7 0



ART	BARCODE	ST.	PREZZO
04 13 60	4004094142079		16,90

GRATTUGIA 'TECHNICUS PRO' FINE INOX 40X3,6 CM WESTMARK

UV1	UV2	IMBALLO
1	6	1/6/48 SL



4 0 0 4 0 9 4 1 4 2 0 7 9



ART	BARCODE	ST.	PREZZO
04 13 62	4004094142475		16,90

GRATTUGIA 'TECHNICUS PRO' GROSSA INOX 40X3,6 CM WESTMARK

UV1	UV2	IMBALLO
1	6	1/6/48 SL



4 0 0 4 0 9 4 1 4 2 4 7 5



ART	BARCODE	ST.	PREZZO
04 13 61	4004094142178		16,90

GRATTUGIA 'TECHNICUS PRO' FINE/MEDIA INOX 40X3,6 CM WESTMARK

UV1	UV2	IMBALLO
1	6	1/6/48 SL



4 0 0 4 0 9 4 1 4 2 1 7 8



ART	BARCODE	ST.	PREZZO
04 06 04	7611264217894		11,25

GRATTUGIA 'PARMA FINO' ACCIAIO INOSSIDABILE 29X6,5 CM MOHA

UV1	UV2	IMBALLO
1	6	1/6/48 SL



7 6 1 1 2 6 4 2 1 7 8 9 4



ART	BARCODE	ST.	PREZZO
04 06 05	7611264217900	A	11,25

GRATTUGIA 'PARMA MEZZO' ACCIAIO
INOSSIDABILE 29X6,5 CM MOHA

UV1	UV2	IMBALLO
1	6	1/6/48 SL



7 6 1 1 2 6 4 2 1 7 9 0 0



ART	BARCODE	ST.	PREZZO
04 06 06	7611264217917		11,90

GRATTUGIA 'PARMA DUO' ACCIAIO
INOSSIDABILE 36X3,8 CM MOHA

UV1	UV2	IMBALLO
1	6	1/6/48 HB



7 6 1 1 2 6 4 2 1 7 9 1 7



ART	BARCODE	ST.	PREZZO
04 06 48*	9003064470315	A	6,50

GRATTUGIA PER RAFANO ACCIAIO
INOSSIDABILE KELOMAT

UV1	UV2	IMBALLO
1	6	1/60 PH



9 0 0 3 0 6 4 4 7 0 3 1 5



ART	BARCODE	ST.	PREZZO
04 06 43	4004094115868		8,80

GRATTUGIA ZENZERO ACCIAIO
INOSSIDABILE 18CM WESTMARK

UV1	UV2	IMBALLO
1	4	1/4/24 HB



4 0 0 4 0 9 4 1 1 5 8 6 8



ART	BARCODE	ST.	PREZZO
04 06 47	4004094115660		8,70

GRATTUGIA ZENZERO ACCIAIO
INOSSIDABILE WESTMARK

UV1	UV2	IMBALLO
1	4	1/4/24 HB



4 0 0 4 0 9 4 1 1 5 6 6 0



ART	BARCODE	ST.	PREZZO
04 06 46	7611264200094		7,55

GRATTUGIA PER ZENZERO 'GINGER'
INOX/ABS Ø 9,5CM MOHA

UV1	UV2	IMBALLO
1	6	1/6/48 HB



7 6 1 1 2 6 4 2 0 0 0 9 4



ART	BARCODE	ST.	PREZZO
04 06 18	4019889122020		29,50

GRATTUGIA+CONTENIT.+COP.
'RAZORTECH' ACCIAIO INOX 13CM
LURCH

UV1	UV2	IMBALLO
1	6	1/6/24 PB



4 0 1 9 8 8 9 1 2 2 0 2 0



ART	BARCODE	ST.	PREZZO
04 06 03	8004537406030		5,10

GRATTUGIA+CONTENITORE ACCIAIO
INOSSIDABILE 16CM EVA

UV1	UV2	IMBALLO
1	12	1/12/96 CD



8 0 0 4 5 3 7 4 0 6 0 3 0



ART	BARCODE	ST.	PREZZO
04 06 07	7611264217887	A	27,50

GRATTUGIA 'EVOLUTION QUATTRO'
ACCIAIO INOSSIDABILE MOHA

UV1	UV2	IMBALLO
1	6	1/6/24 SL



7 6 1 1 2 6 4 2 1 7 8 8 7



ART	BARCODE	ST.	PREZZO
04 06 08	8004537406085		7,25

GRATTUGIA 4 FACCE ACCIAIO
INOSSIDABILE 21CM EVA

UV1	UV2	IMBALLO
1	12	1/12/48 SL



8 0 0 4 5 3 7 4 0 6 0 8 5



ART	BARCODE	ST.	PREZZO
04 06 09	8004537406092		9,40

GRATTUGIA 4 FACCE ACCIAIO
INOSSIDABILE 24CM EVA

UV1	UV2	IMBALLO
1	6	1/6/24 SL



8 0 0 4 5 3 7 4 0 6 0 9 2



ART	BARCODE	ST.	PREZZO
04 06 14	8004537406146		13,20

GRATTUGIA 4 FACCE ACCIAIO
INOSSIDABILE SPEZIAL 24 CM EVA

UV1	UV2	IMBALLO
1	12	1/12/48 SL



8 0 0 4 5 3 7 4 0 6 1 4 6



ART	BARCODE	ST.	PREZZO
04 13 58	4004094116919		2,15

GRATTUGIA MINI ASSORTITA ACCIAIO INOX IN DISPLAY WESTMARK

UV1	UV2	IMBALLO
18	36	1/18/144 DB



4 0 0 4 0 9 4 1 1 6 9 1 9



ART	BARCODE	ST.	PREZZO
02 18 07	8001603020107		5,25

SPAZZOLINO PULISCI GRATTUGIE COLORI ASSORTITI GHIDINI

UV1	UV2	IMBALLO
1	12	1/24 CD



8 0 0 1 6 0 3 0 2 0 1 0 7



ART	BARCODE	ST.	PREZZO
04 20 37	4006501221384		12,20

AFFETTAVERDURE+4 LAME ABS 29 CM LEIFHEIT

UV1	UV2	IMBALLO
1	3	1/6 HB



4 0 0 6 5 0 1 2 2 1 3 8 4



ART	BARCODE	ST.	PREZZO
04 06 50	8021084436402		1,50

GRATTUGIA DOPPIA PLASTICA

UV1	UV2	IMBALLO
1	10	1/120 PH



8 0 2 1 0 8 4 4 3 6 4 0 2



ART	BARCODE	ST.	PREZZO
04 06 49	8000042011714		2,20

AFFETTAVERDURE 'SUPER' PLASTICA 30 CM EUROMARKETING 90

UV1	UV2	IMBALLO
1	10	1/140 PH



8 0 0 0 0 4 2 0 1 1 7 1 4



ART	BARCODE	ST.	PREZZO
04 06 78	4004094100277		7,35

GRATTUGIA UNIVERSALE ACCIAIO INOSSIDABILE WESTMARK

UV1	UV2	IMBALLO
1	6	1/6/48 CD



4 0 0 4 0 9 4 1 0 0 2 7 7



ART	BARCODE	ST.	PREZZO
04 06 79	4004094100376		7,35

GRATTUGIA VERDURE ACCIAIO INOSSIDABILE WESTMARK

UV1	UV2	IMBALLO
1	6	1/6/48 CD



4 0 0 4 0 9 4 1 0 0 3 7 6



ART	BARCODE	ST.	PREZZO
04 06 80	4004094100475		7,35

GRATTUGIA VERDURE/CRUDITE' ACCIAIO INOSSIDABILE WESTMARK

UV1	UV2	IMBALLO
1	6	1/6/48 CD



4 0 0 4 0 9 4 1 0 0 4 7 5



ART	BARCODE	ST.	PREZZO
04 06 83	4004094100574	A	7,35

GRATTUGIA FORMAGGIO/CIOCCOLATO ACCIAIO INOSSID. WESTMARK

UV1	UV2	IMBALLO
1	6	1/6/48 CD



4 0 0 4 0 9 4 1 0 0 5 7 4



ART	BARCODE	ST.	PREZZO
04 06 84	4004094100673		7,35

GRATTUGIA A FETTE ACCIAIO INOSSIDABILE WESTMARK

UV1	UV2	IMBALLO
1	6	1/6/48 CD



4 0 0 4 0 9 4 1 0 0 6 7 3



ART	BARCODE	ST.	PREZZO
04 06 30	7610859153883		11,25

AFFETTAVERDURA 'BASIC' PS 18,5 CM ROTHO

UV1	UV2	IMBALLO
1	10	1/10 CD



7 6 1 0 8 5 9 1 5 3 8 8 3



ART	BARCODE	ST.	PREZZO
04 04 85	4004094114762		15,30

AFFETTAVERDURE LAMA A V 'V-HOBEL' ABS/LAMA INOX WESTMARK

UV1	UV2	IMBALLO
1	6	1/3/24 HB



4 0 0 4 0 9 4 1 1 4 7 6 2



ART	BARCODE	ST.	PREZZO
04 06 28	4004094106576		8,10

AFFETTAVERDURE REGOLABILE PS WESTMARK

UV1	UV2	IMBALLO
1	5	1/5/30 CD



4 0 0 4 0 9 4 1 0 6 5 7 6



ART	BARCODE	ST.	PREZZO
04 06 32	4004094113277		6,50

AFFETTA VERDURA 'FAMOS' PS/ACCIAIO INOSSIDABILE WESTMARK

UV1	UV2	IMBALLO
1	5	1/5/50 SL



4 0 0 4 0 9 4 1 1 3 2 7 7



ART	BARCODE	ST.	PREZZO
04 06 35	4004094106675		3,40

AFFETTAVERDURE 'KÜCHENMAID' PS/LAMA INOX INOSSIDAB.WESTMARK

UV1	UV2	IMBALLO
1	10	1/10/50 CD



4 0 0 4 0 9 4 1 0 6 6 7 5



ART	BARCODE	ST.	PREZZO
04 06 36	4004094117077		4,10

AFFETTAVERDURE 'HOBELIX' ABS/LAMA ACCIAIO INOSSIDAB.WESTMARK

UV1	UV2	IMBALLO
1	6	1/6/36 CD



4 0 0 4 0 9 4 1 1 7 0 7 7



ART	BARCODE	ST.	PREZZO
04 06 37	4004094013997		9,90

SET GRATTUGIA CHIPS MAKER+PIATTO MICROOND "CRUNCHY" WESTMARK

UV1	UV2	IMBALLO
1	8	1/8 PB



4 0 0 4 0 9 4 0 1 3 9 9 7



ART	BARCODE	ST.	PREZZO
04 06 33	4014544300119	A	30,50

AFFETTAVERDURE UNIVERSALE 3 LAME ABS ROSSO 30CM GSD

UV1	UV2	IMBALLO
1	4	1/48 HB



4 0 1 4 5 4 4 3 0 0 1 1 9



ART	BARCODE	ST.	PREZZO
04 06 31	4014544300003		32,50

AFFETTAVERDURE UNIVERSALE 3 LAME ABS BIANCO 30CM GSD

UV1	UV2	IMBALLO
1	5	1/48 HB



4 0 1 4 5 4 4 3 0 0 0 0 3



ART	BARCODE	ST.	PREZZO
04 06 44	7611264252079		26,50

AFFETTAVERDURE MANDOLINA LAMA A V 'VEGGIE V' MOHA

UV1	UV2	IMBALLO
1	6	1/6/12 PB



7 6 1 1 2 6 4 2 5 2 0 7 9



ART	BARCODE	ST.	PREZZO
04 06 45	7611264252086	A	47,80

AFFETTAVERDURE MANDOLINA 4 LAME 'VEGGIE PRO' MOHA

UV1	UV2	IMBALLO
1	8	1/8 PB



7 6 1 1 2 6 4 2 5 2 0 8 6



ART	BARCODE	ST.	PREZZO
04 06 54	8004537406542		73,00

AFFETTAVERDURE MANDOLINA ACCIAIO INOSSIDABILE 18/8 40CM EVA

UV1	UV2	IMBALLO
1	4	1/8 PB



8 0 0 4 5 3 7 4 0 6 5 4 2



ART	BARCODE	ST.	PREZZO
04 06 41	7611264252253	A	24,80

GRATTUGIA 4 LAME 'MANDOLINETTA' MOHA

UV1	UV2	IMBALLO
1	6	1/6/12 PB



7 6 1 1 2 6 4 2 5 2 2 5 3



ART	BARCODE	ST.	PREZZO
02 18 40	4004094117169		29,50

AFFETTAVERDURA 'SCHNITZEL MOULI' ABS/INOX WESTMARK

UV1	UV2	IMBALLO
1	6	1/6 PB



4 0 0 4 0 9 4 1 1 7 1 6 9



ART	BARCODE	ST.	PREZZO
04 06 34	4019889135303		28,50

AFFETTAVERDURE MANDOLINA 'VARIO' 3 LAME LURCH

UV1	UV2	IMBALLO
1	6	1/3/12 PB



4 0 1 9 8 8 9 1 3 5 3 0 3



ART	BARCODE	ST.	PREZZO
04 06 19	4019889138052		14,10

AFFETTAVERDURE A MANDOLINA 32 CM LURCH

UV1	UV2	IMBALLO
1	6	1/6/24 CD



4 0 1 9 8 8 9 1 3 8 0 5 2



ART	BARCODE	ST.	PREZZO
04 06 20	4019889138069		14,10

AFFETTAVERDURE A JULIENNE 32 CM LURCH

UV1	UV2	IMBALLO
1	6	1/6/24 CD



4 0 1 9 8 8 9 1 3 8 0 6 9



ART	BARCODE	ST.	PREZZO
04 06 23	4019889135181		24,50

TAGLIAVERDURE A CUBETTI/STRISCIE 'KUBUS' 2 LAME LURCH

UV1	UV2	IMBALLO
1	6	1/6 PB



4 0 1 9 8 8 9 1 3 5 1 8 1



ART	BARCODE	ST.	PREZZO
04 13 75	4004094971167		53,50

SET AFFETTATORE MULTIUSO 'DICER STAR PLUS' ABS/PP/INOX WESTM

UV1	UV2	IMBALLO
1	3	1/3/12 PB



4 0 0 4 0 9 4 9 7 1 1 6 7



ART	BARCODE	ST.	PREZZO
02 17 23	4019889014721		5,95

SBUCCIATORE PER ARANCIA 16 CM LURCH

UV1	UV2	IMBALLO
1	6	1/100 CD



4 0 1 9 8 8 9 0 1 4 7 2 1



ART	BARCODE	ST.	PREZZO
04 06 22	8004537406221		5,45

TAGLIATARTUFI/FORMAGGIO LISCI ACCIAIO INOSSIDABILE EVA

UV1	UV2	IMBALLO
1	6	1/12/96 HB



8 0 0 4 5 3 7 4 0 6 2 2 1



ART	BARCODE	ST.	PREZZO
04 06 66	4004094609060		3,65

SBUCCIATORE VERDURA 'STEEL' ACCIAIO INOSSIDABILE WESTMARK

UV1	UV2	IMBALLO
1	5	1/5/45 CD



4 0 0 4 0 9 4 6 0 9 0 6 0



ART	BARCODE	ST.	PREZZO
04 07 47	8004537407471		2,35

PELAPATATE/SBUCCIATORE ACCIAIO INOSSIDABILE EVA

UV1	UV2	IMBALLO
1	12	1/12/120 BC



8 0 0 4 5 3 7 4 0 7 4 7 1



ART	BARCODE	ST.	PREZZO
04 07 95	8004537407952		2,95

PELAPATATE/SBUCCIATORE ALLUMINIO EVA

UV1	UV2	IMBALLO
1	12	1/12/120 BC



8 0 0 4 5 3 7 4 0 7 9 5 2



ART	BARCODE	ST.	PREZZO
04 54 01	8004537454017		1,25

SBUCCIATORE 'EASY' COLORI ASSORTITI EVA

UV1	UV2	IMBALLO
1	6	1/12/120 BC



8 0 0 4 5 3 7 4 5 4 0 1 7



ART	BARCODE	ST.	PREZZO
04 13 44	4004094609572		7,95

SBUCCIATORE VERDURA 'QUICK' AL/ACCIAIO INOSSIDABILE WESTMARK

UV1	UV2	IMBALLO
1	5	1/10/100 CD



4 0 0 4 0 9 4 6 0 9 5 7 2



ART	BARCODE	ST.	PREZZO
04 13 15	4004094609671		8,30

TAGLIA JULIENNE 'QUICK
SPEZIAL'AL/INOX INOSSIDABILE
WESTMARK

UV1	UV2	IMBALLO
1	10	1/10/60 CD



4 0 0 4 0 9 4 6 0 9 6 7 1



ART	BARCODE	ST.	PREZZO
04 06 64	7611264457207		5,90

SBUCCIATORE A JULIENNE 'JULIENNE'
ARANCIONE MOHA

UV1	UV2	IMBALLO
1	12	1/12/120 HB



7 6 1 1 2 6 4 4 5 7 2 0 7



ART	BARCODE	ST.	PREZZO
04 13 95	4004094105883		7,65

SBUCCIATORE
PATATE+POMODORI+JULIENNE 'TRIO'
WESTMARK

UV1	UV2	IMBALLO
1	6	1/6/36 DC



4 0 0 4 0 9 4 1 0 5 8 8 3



ART	BARCODE	ST.	PREZZO
04 06 72	4004094105715		1,85

SBUCCIATORE 'U-TYP' PP COLORI
ASSORTITI IN DISPLAY WESTMARK

UV1	UV2	IMBALLO
24	48	1/24 DB



4 0 0 4 0 9 4 1 0 5 7 1 5



ART	BARCODE	ST.	PREZZO
05 32 03*	4008502501380		2,85

SBUCCIATORE FINO VERDURA
'DIAMANT' IN DISPLAY

UV1	UV2	IMBALLO
30	60	1/30 DB



4 0 0 8 5 0 2 5 0 1 3 8 0



ART	BARCODE	ST.	PREZZO
05 34 73*	8004537534733	H	2,30

SBUCCIATORE VERDURA CERAMICO
COLORI ASSORTITI EVA

UV1	UV2	IMBALLO
1	10	1/10/120 SC



8 0 0 4 5 3 7 5 3 4 7 3 3



ART	BARCODE	ST.	PREZZO
05 34 71*	8004537534719		2,90

PELAPATATE CERAMICA ASSORTITO
EVA

UV1	UV2	IMBALLO
1	12	1/12/144 CD



8 0 0 4 5 3 7 5 3 4 7 1 9



ART	BARCODE	ST.	PREZZO
05 34 72	8004537534726		2,50

PELAPATATE CERAMICA ASSORTITO
DISPLAY

UV1	UV2	IMBALLO
20	60	20/20 DB



8 0 0 4 5 3 7 5 3 4 7 2 6



ART	BARCODE	ST.	PREZZO
04 53 93*	7611264456200	H	8,50

SBUCCIATORE INOX DOPPIA POSIZIONE
'REVERSO JULIENNE' MOHA

UV1	UV2	IMBALLO
1	6	1/6/48 CD



7 6 1 1 2 6 4 4 5 6 2 0 0



ART	BARCODE	ST.	PREZZO
04 13 13	4004094106170		3,90

PELA PATATE 'FAMOS' ACCIAIO
INOSSIDABILE/CROMATO WESTMARK

UV1	UV2	IMBALLO
1	10	1/10/110 CD



4 0 0 4 0 9 4 1 0 6 1 7 0



ART	BARCODE	ST.	PREZZO
04 07 65	4010303035001		5,20

SBUCCIATORE VERDURA A 2 LAME
GIESSER

UV1	UV2	IMBALLO
1	12	1/12 BK



4 0 1 0 3 0 3 0 3 5 0 0 1



ART	BARCODE	ST.	PREZZO
04 13 37	4004094294679		7,60

SBUCCIATORE POMODORI/KIWI 'TOMFIX'
GALLANT PP/ALLU WESTMARK

UV1	UV2	IMBALLO
1	10	1/6/72 CD



4 0 0 4 0 9 4 2 9 4 6 7 9



ART	BARCODE	ST.	PREZZO
04 13 31	4004094294617		7,50

SBUCCIATORE POMODORI/KIWI 'TOMFIX GALLANT' PP/AL IN DISPLAY

UV1	UV2	IMBALLO
12	24	1/12 DB



4 0 0 4 0 9 4 2 9 4 6 1 7



ART	BARCODE	ST.	PREZZO
04 06 61	7611264101025		5,80

SBUCCIATORE PER PATATE 'PELA' NERO MOHA

UV1	UV2	IMBALLO
1	12	1/12/120 HB



7 6 1 1 2 6 4 1 0 1 0 2 5



ART	BARCODE	ST.	PREZZO
04 06 67	8004537406672	A	4,95

PELA ASPARAGI ACCIAIO INOSSIDABILE 18/8 EVA

UV1	UV2	IMBALLO
1	12	1/12/216 HB



8 0 0 4 5 3 7 4 0 6 6 7 2



ART	BARCODE	ST.	PREZZO
04 07 56	4004094607066	A	6,55

SBUCCIATORE ASPARAGI ACCIAIO INOSSIDABILE WESTMARK

UV1	UV2	IMBALLO
1	5	1/5/80 HB



4 0 0 4 0 9 4 6 0 7 0 6 6



ART	BARCODE	ST.	PREZZO
04 54 06	8004537454062	H	2,60

SBUCCIATORE 'FINGERPEELER' ASSORT IN DISPLAY

UV1	UV2	IMBALLO
12	36	12/12 DB



8 0 0 4 5 3 7 4 5 4 0 6 2



ART	BARCODE	ST.	PREZZO
04 07 53	8004537407532	A	4,70

SCAVINO DOPPIO PATATE ACCIAIO INOSSIDABILE 18/8 EVA

UV1	UV2	IMBALLO
1	12	1/12/144 CD



8 0 0 4 5 3 7 4 0 7 5 3 2



ART	BARCODE	ST.	PREZZO
02 17 22	4004094516160		13,00

SGRANA-MELOGRANO "BUZZER" WESTMARK

UV1	UV2	IMBALLO
1	3	1/3/24 PB



4 0 0 4 0 9 4 5 1 6 1 6 0



ART	BARCODE	ST.	PREZZO
02 11 13	8004537211139		12,50

PELAMELE/PATATE GHISA ALLUMINIO EVA

UV1	UV2	IMBALLO
1	6	1/12 PB



8 0 0 4 5 3 7 2 1 1 1 3 9



ART	BARCODE	ST.	PREZZO
04 06 57	4004094513060	A	8,70

TAGLIARAVANELLO 'RADIMAX' ALL./ACCIAIO INOSSIDAB. WESTMARK

UV1	UV2	IMBALLO
1	5	1/5/60 HB



4 0 0 4 0 9 4 5 1 3 0 6 0



ART	BARCODE	ST.	PREZZO
02 18 41	4004094113369	A	47,90

AFFETTAVERDURE 'SPIROMAT' ABS/ACCIAIO INOSSIDABILE WESTMARK

UV1	UV2	IMBALLO
1	3	1/6 PB



4 0 0 4 0 9 4 1 1 3 3 6 9



ART	BARCODE	ST.	PREZZO
02 18 42	4019889133392		36,50

AFFETTAVERDURE 'SPIRALSCHNEIDER' LURCH

UV1	UV2	IMBALLO
1	0	1/3 PB



4 0 1 9 8 8 9 1 3 3 3 9 2



ART	BARCODE	ST.	PREZZO
04 13 35	4004094116568		20,30

AFFETTAVERDURE A SPIRALE 'TRIOLO' ABS/INOX WESTMARK

UV1	UV2	IMBALLO
1	6	1/6/36 HB



4 0 0 4 0 9 4 1 1 6 5 6 8



ART	BARCODE	ST.	PREZZO
04 13 38	4004094116261		11,30

AFFETTAVERDURE A SPIRALE 'DUOLO'
ABS/INOX WESTMARK

UV1	UV2	IMBALLO
1	3	1/3/24 HB



4 0 0 4 0 9 4 1 1 6 2 6 1



ART	BARCODE	ST.	PREZZO
04 13 16	4004094512575	A	5,80

GRATTUGIA DECORATIVA 'MÖHRFIX'
ABS/INOX INOSSIDAB. WESTMARK

UV1	UV2	IMBALLO
1	6	1/6/48 BC



4 0 0 4 0 9 4 5 1 2 5 7 5



ART	BARCODE	ST.	PREZZO
04 13 80	4004094512513		5,85

GRATTUGIA DECORATIVA 'MÖHRFIX'
ABS/INOX IN DISPLAY WESTMARK

UV1	UV2	IMBALLO
12	24	1/12/36 DB



4 0 0 4 0 9 4 5 1 2 5 1 3

Girare Mescolare Battere



ART	BARCODE	ST.	PREZZO
04 02 38	8004537402384		4,40

**SPATOLA ACCIAIO INOSSIDABILE
MANICO PLASTICA EVA**

UV1	UV2	IMBALLO
1	12	1/12/120 HT



8 0 0 4 5 3 7 4 0 2 3 8 4



ART	BARCODE	ST.	PREZZO
04 02 39	8004537402391		5,40

**SPATOLA ACCIAIO INOSSIDABILE
MANICO BACHELITE 29CM EVA**

UV1	UV2	IMBALLO
1	12	1/12/120 HT



8 0 0 4 5 3 7 4 0 2 3 9 1



ART	BARCODE	ST.	PREZZO
04 02 46	7611264507407		13,90

**SPATOLA ACCIAIO INOSSIDABILE 18/10 +
SILICONE 'CURVA' MOHA**

UV1	UV2	IMBALLO
1	12	1/12/72 CD



7 6 1 1 2 6 4 5 0 7 4 0 7



ART	BARCODE	ST.	PREZZO
04 02 47	7611264507384		13,20

**PALETTA ACCIAIO INOSSIDABILE 18/10 +
SILICONE 'SPALA' MOHA**

UV1	UV2	IMBALLO
1	12	1/6/72 CD



7 6 1 1 2 6 4 5 0 7 3 8 4



ART	BARCODE	ST.	PREZZO
04 02 45	4004094157073		9,20

**PALETTA/SPATOLA 'FLEXI' PA 31 CM
WESTMARK**

UV1	UV2	IMBALLO
1	5	1/5/50 CD



4 0 0 4 0 9 4 1 5 7 0 7 3



ART	BARCODE	ST.	PREZZO
04 50 88	4009085185721	A	4,40

PALETTA PBT ASSORTITA 29CM WACA

UV1	UV2	IMBALLO
1	10	1/5 CD



4 0 0 9 0 8 5 1 8 5 7 2 1



ART	BARCODE	ST.	PREZZO
04 50 82	4009085212731		2,40

**PALETTA FORATA PBT ASSORTITA 26CM
WACA**

UV1	UV2	IMBALLO
1	10	1/10 CD



4 0 0 9 0 8 5 2 1 2 7 3 1



ART	BARCODE	ST.	PREZZO
04 50 86	4009085254816	A	3,20

CUCCHIAIONE PBT BIANCO 26CM WACA

UV1	UV2	IMBALLO
1	10	1/5 CD



4 0 0 9 0 8 5 2 5 4 8 1 6



ART	BARCODE	ST.	PREZZO
04 50 81	4009085212724		2,40

**CUCCHIAIO ROTONDO PBT ASSORTITO
30CM WACA**

UV1	UV2	IMBALLO
1	10	1/10 CD



4 0 0 9 0 8 5 2 1 2 7 2 4



ART	BARCODE	ST.	PREZZO
04 50 83	4009085213073		3,60

**CUCCHIAIO VERDURE PBT BIANCO 30CM
WACA**

UV1	UV2	IMBALLO
1	10	1/5 CD



4 0 0 9 0 8 5 2 1 3 0 7 3



ART	BARCODE	ST.	PREZZO
04 50 84	4009085213059	A	3,50

**CUCCHIAIO FORATO PBT BIANCO 31CM
WACA**

UV1	UV2	IMBALLO
1	10	1/5 CD



4 0 0 9 0 8 5 2 1 3 0 5 9



ART	BARCODE	ST.	PREZZO
04 50 87	4009085257275		2,40

**CUCCHIAIO PUNTA+FORO PBT BIANCO
31CM WACA**

UV1	UV2	IMBALLO
1	5	1/5 CD



4 0 0 9 0 8 5 2 5 7 2 7 5



ART	BARCODE	ST.	PREZZO
04 50 91	4009085240475		5,10

CUCCHIAIO ROTONDO GASTRO PBT BIANCO 38CM WACA

UV1	UV2	IMBALLO
1	10	1/5 CD



4 0 0 9 0 8 5 2 4 0 4 7 5



ART	BARCODE	ST.	PREZZO
04 50 92	4009085240482	A	7,60

CUCCHIAIO ROTONDO GASTRO PBT BIANCO 45CM WACA

UV1	UV2	IMBALLO
1	5	1/5 CD



4 0 0 9 0 8 5 2 4 0 4 8 2



ART	BARCODE	ST.	PREZZO
04 50 93	4009085240499	A	11,90

CUCCHIAIO ROTONDO GASTRO PBT BIANCO 57CM WACA

UV1	UV2	IMBALLO
1	5	1/5 CD



4 0 0 9 0 8 5 2 4 0 4 9 9



ART	BARCODE	ST.	PREZZO
04 50 80	4009085250788		2,75

CUCCHIAI+PALETTE PBT COLORI ASSORTI IN DISPLAY WACA

UV1	UV2	IMBALLO
40	80	1/40 PG



4 0 0 9 0 8 5 2 5 0 7 8 8



ART	BARCODE	ST.	PREZZO
04 03 90	4000270693908		5,70

BATTICARNE LEGNO DI FAGGIO FSC 28 CM KESPER

UV1	UV2	IMBALLO
1	10	1/5 CD



4 0 0 0 2 7 0 6 9 3 9 0 8



ART	BARCODE	ST.	PREZZO
04 03 94	8004537403947		8,95

BATTICARNE A PUGNO ACCIAIO INOSSIDABILE 500G EVA

UV1	UV2	IMBALLO
1	6	1/6/24 PB



8 0 0 4 5 3 7 4 0 3 9 4 7



ART	BARCODE	ST.	PREZZO
04 13 18	4004094621062		13,75

BATTICARNE 'ROBUSTO' ALLUMINIO 21 CM WESTMARK

UV1	UV2	IMBALLO
1	5	1/5/20 HB



4 0 0 4 0 9 4 6 2 1 0 6 2



ART	BARCODE	ST.	PREZZO
04 13 19	4004094620065		23,30

BATTICARNE 'ROBUSTO SPEZIAL' ALLUMINIO 24 CM WESTMARK

UV1	UV2	IMBALLO
1	6	1/3/12 HB



4 0 0 4 0 9 4 6 2 0 0 6 5



ART	BARCODE	ST.	PREZZO
04 03 95	9003064470544		9,40

BATTICARNE 2 FACCE KELOMAT

UV1	UV2	IMBALLO
1	6	1/6/36 HT



9 0 0 3 0 6 4 4 7 0 5 4 4



ART	BARCODE	ST.	PREZZO
04 03 87	8004537403879	A	3,95

BATTICARNE IN ALLUMINIO GRIGIO 23CM-200G EVA

UV1	UV2	IMBALLO
1	6	1/12/36 CD



8 0 0 4 5 3 7 4 0 3 8 7 9



ART	BARCODE	ST.	PREZZO
04 03 86	8004537403862	H	6,90

BATTICARNE IN ALLUMINIO GRIGIO 25CM-400G EVA

UV1	UV2	IMBALLO
1	6	1/6/24 CD



8 0 0 4 5 3 7 4 0 3 8 6 2



ART	BARCODE	ST.	PREZZO
04 03 38	8004537403381	A	12,90

SBATTITORE MANUALE "RÜHRMEISTER" 1 LITRO EVA

UV1	UV2	IMBALLO
1	12	1/12 PB



8 0 0 4 5 3 7 4 0 3 3 8 1

Aprire Chiudere



ART	BARCODE	ST.	PREZZO
04 07 52	8004537407525		3,70

ROMPINOCI/PINZA ALLUMINIO/LEGNO EVA

UV1	UV2	IMBALLO
1	6	1/16/48 CD



8 0 0 4 5 3 7 4 0 7 5 2 5



ART	BARCODE	ST.	PREZZO
04 07 60	4004094332777		9,70

ROMPINOCI/PINZA CHAMPAGNE 'NUSSPROFI' SIEGER

UV1	UV2	IMBALLO
1	10	1/10/40 CD



4 0 0 4 0 9 4 3 3 2 7 7 7



ART	BARCODE	ST.	PREZZO
04 13 69	4004094332579		8,95

ROMPINOCI/PINZA CHAMPAGNE 'NUSSPROFI' NERO SIEGER

UV1	UV2	IMBALLO
1	10	1/10/40 CD



4 0 0 4 0 9 4 3 3 2 5 7 9



ART	BARCODE	ST.	PREZZO
04 07 66	8004537407662		4,10

ROMPINOCI ALLUMINIO GRIGIO ANTRACITE EVA

UV1	UV2	IMBALLO
1	6	1/12/48 CD



8 0 0 4 5 3 7 4 0 7 6 6 2



ART	BARCODE	ST.	PREZZO
04 13 52	4004094332067	A	14,20

ROMPINOCI 'COCO' ALLUMINIO WESTMARK

UV1	UV2	IMBALLO
1	5	1/5/65 HB



4 0 0 4 0 9 4 3 3 2 0 6 7



ART	BARCODE	ST.	PREZZO
04 07 63	8004537407631		4,75

ROMPINOCI MANICO LEGNO SCURO 18CM EVA

UV1	UV2	IMBALLO
1	6	1/12/144 CD



8 0 0 4 5 3 7 4 0 7 6 3 1



ART	BARCODE	ST.	PREZZO
04 07 57	8004537407570		7,60

ROMPINOCI/ROMPIGAMBERO ACCIAIO INOSSIDABILE 18/8 EVA

UV1	UV2	IMBALLO
1	12	1/12/120 CD



8 0 0 4 5 3 7 4 0 7 5 7 0



ART	BARCODE	ST.	PREZZO
04 02 71	4004094167584		37,50

SCIACCIANOCI 'PREZIOSO' SATINATO WESTMARK MONOPOL EDITION

UV1	UV2	IMBALLO
1	2	1/10 PB



4 0 0 4 0 9 4 1 6 7 5 8 4



ART	BARCODE	ST.	PREZZO
04 07 68	4004094167263		19,10

SCIACCIANOCI 'TRIANGOLO' LEGA DI ZINCO WESTMARK MONOPOL ED.

UV1	UV2	IMBALLO
1	10	1/10 HB



4 0 0 4 0 9 4 1 6 7 2 6 3



ART	BARCODE	ST.	PREZZO
04 07 61	8008636034323		4,50

ROMPINOCI DOPPIO USO CROMATO GHIDINI

UV1	UV2	IMBALLO
1	12	1/12/72 BC



8 0 0 8 6 3 6 0 3 4 3 2 3



ART	BARCODE	ST.	PREZZO
04 13 68	4004094330070		6,00

SCIACCIANOCI 'HERKULES' ALLUMINIO WESTMARK

UV1	UV2	IMBALLO
1	5	1/5/70 CD



4 0 0 4 0 9 4 3 3 0 0 7 0



ART	BARCODE	ST.	PREZZO
04 07 64	4004094167775		8,90

SCIACCIANOCI 'HOLZI' IN LEGNO WESTMARK

UV1	UV2	IMBALLO
1	3	1/3/24 HT



4 0 0 4 0 9 4 1 6 7 7 7 5



ART	BARCODE	ST.	PREZZO
04 07 03	4004094112171		11,50

APRISCATOLE A LEVA 'ORIGINAL SIEGER' ACCIAIO WESTMARK

UV1	UV2	IMBALLO
1	3	1/3/30 CD



4 0 0 4 0 9 4 1 1 2 1 7 1



ART	BARCODE	ST.	PREZZO
04 06 82	4000270628306		11,90

ROMPINOCI+CIOTOLA BAMBU FSC 30X16CM KESPER

UV1	UV2	IMBALLO
1	4	1/4 SP



4 0 0 0 2 7 0 6 2 8 3 0 6



ART	BARCODE	ST.	PREZZO
04 07 11	4004094102578		4,20

APRISCATOLE A LEVA 'COLUMBUS' ACCIAIO WESTMARK

UV1	UV2	IMBALLO
1	10	1/10/100 CD



4 0 0 4 0 9 4 1 0 2 5 7 8



ART	BARCODE	ST.	PREZZO
04 07 04	4004094122873		15,70

APRISCATOLE 'SIEGER BOY' PA/ACCIAIO SIEGER

UV1	UV2	IMBALLO
1	5	1/5/20 CD



4 0 0 4 0 9 4 1 2 2 8 7 3



ART	BARCODE	ST.	PREZZO
04 07 08	4004094122262		14,80

APRISCATOLE 'AUTOMATIC' PA/ACCIAIO WESTMARK MONOPOL EDITION

UV1	UV2	IMBALLO
1	5	1/40 HB



4 0 0 4 0 9 4 1 2 2 2 6 2



ART	BARCODE	ST.	PREZZO
04 07 09	4004094122460		26,00

APRISCATOLE PROFESSION. 'TITAN' ACCIAIO WESTMARK MONOPOL ED.

UV1	UV2	IMBALLO
1	5	1/55 HB



4 0 0 4 0 9 4 1 2 2 4 6 0



ART	BARCODE	ST.	PREZZO
04 07 39	7611264605615		19,80

APRISCATOLE DI SICUREZZA 'PALM' MOHA

UV1	UV2	IMBALLO
1	6	1/6/48 HB



7 6 1 1 2 6 4 6 0 5 6 1 5



ART	BARCODE	ST.	PREZZO
04 07 05	4004094103179		21,00

APRISCATOLE A PINZA 'ZANGEN-SIEGER' ST/PA SIEGER

UV1	UV2	IMBALLO
1	10	1/5/20 CD



4 0 0 4 0 9 4 1 0 3 1 7 9



ART	BARCODE	ST.	PREZZO
04 54 02	8004537454024		6,50

APRISCATOLE DI SICUREZZA EVA COLORI ASSORTITI

UV1	UV2	IMBALLO
1	6	1/18 CD



8 0 0 4 5 3 7 4 5 4 0 2 4



ART	BARCODE	ST.	PREZZO
04 07 40	7611264100042		13,20

APRISCATOLE DI SICUREZZA 'SEGURO' MOHA

UV1	UV2	IMBALLO
1	12	1/12/48 HB



7 6 1 1 2 6 4 1 0 0 0 4 2



ART	BARCODE	ST.	PREZZO
04 20 60	4006501031419		11,60

APRISCATOLE BIANCO LEIFHEIT

UV1	UV2	IMBALLO
1	6	1/3/36 CD



4 0 0 6 5 0 1 0 3 1 4 1 9



ART	BARCODE	ST.	PREZZO
04 07 01	4004094112676		11,75

APRISCATOLE A PINZA ASSORTITO PP/ACCIAIO SIEGER WESTMARK

UV1	UV2	IMBALLO
1	15	1/5/15 CD



4 0 0 4 0 9 4 1 1 2 6 7 6



ART	BARCODE	ST.	PREZZO
04 53 95	4004094284076		12,75

APRISCATOLE 'GENTLE' PA 21 CM WESTMARK

UV1	UV2	IMBALLO
1	3	1/3/15 CD



4 0 0 4 0 9 4 2 8 4 0 7 6



ART	BARCODE	ST.	PREZZO
04 54 19	8004537454192		3,75

APRISCATOLE 'PRIMA BIANCO' EVA

UV1	UV2	IMBALLO
1	6	1/6/60 BC



8 0 0 4 5 3 7 4 5 4 1 9 2



ART	BARCODE	ST.	PREZZO
04 54 20	8004537454208		3,75

SVITATAPPI 'PRIMA BIANCO' EVA

UV1	UV2	IMBALLO
1	6	1/6/108 CD



8 0 0 4 5 3 7 4 5 4 2 0 8



ART	BARCODE	ST.	PREZZO
04 07 17	4004094105579		5,20

APRI-COPERCHI MULTIFUNZIONE 25CM WESTMARK

UV1	UV2	IMBALLO
1	3	1/3/24 CD



4 0 0 4 0 9 4 1 0 5 5 7 9



ART	BARCODE	ST.	PREZZO
04 07 06	4004094104879		4,30

APRI-COPERCHI "MOBY DICK" 23CM WESTMARK

UV1	UV2	IMBALLO
1	3	1/3/24 CD



4 0 0 4 0 9 4 1 0 4 8 7 9



ART	BARCODE	ST.	PREZZO
04 07 07	4004094105074		7,15

SVITATAPPI 6 IN 1 ACCIAIO WESTMARK

UV1	UV2	IMBALLO
1	5	1/5/40 CD



4 0 0 4 0 9 4 1 0 5 0 7 4



ART	BARCODE	ST.	PREZZO
04 07 18	8004537407181		112,00

APRISCATOLE DA BANCO EVA

UV1	UV2	IMBALLO
1	4	1/8 LB



8 0 0 4 5 3 7 4 0 7 1 8 1



ART	BARCODE	ST.	PREZZO
04 07 87	4004094198069		161,00

APRISCATOLE ALBERGHIERO 'CLOU 30' ACCIAIO SIEGER

UV1	UV2	IMBALLO
1	2	1/6 PB



4 0 0 4 0 9 4 1 9 8 0 6 9



ART	BARCODE	ST.	PREZZO
04 07 88	4004094198564		166,50

APRISCATOLE ALBERGHIERO 'CLOU 40' ACCIAIO SIEGER

UV1	UV2	IMBALLO
1	2	1/1 PB



4 0 0 4 0 9 4 1 9 8 5 6 4



ART	BARCODE	ST.	PREZZO
04 07 20	8004537407204		38,50

LEVATAPPI DA PARETE EVA

UV1	UV2	IMBALLO
1	3	1/6 PB



8 0 0 4 5 3 7 4 0 7 2 0 4

Mantenere Fresco Conservazione



ART	BARCODE	ST.	PREZZO
02 27 21	8008250400061		11,75

100 SACCHETTI GOFFRATI 15X25CM
VIOSAC

UV1	UV2	IMBALLO
1	5	1/25 PG



8 0 0 8 2 5 0 4 0 0 0 6 1



ART	BARCODE	ST.	PREZZO
02 27 22	8008250400016		18,75

100 SACCHETTI GOFFRATI 20X30CM
VIOSAC

UV1	UV2	IMBALLO
1	4	1/16 PG



8 0 0 8 2 5 0 4 0 0 0 1 6



ART	BARCODE	ST.	PREZZO
02 27 23	8008250400023		27,25

100 SACCHETTI GOFFRATI 25X35CM
VIOSAC

UV1	UV2	IMBALLO
1	5	1/10 PG



8 0 0 8 2 5 0 4 0 0 0 2 3



ART	BARCODE	ST.	PREZZO
02 81 83	4006160101553		25,00

2 ROTOLI 6M SACCHETTI 28CM
P/MACCHINA SOTTOV.02180 PROFICOOK

UV1	UV2	IMBALLO
1	6	1/6 PB



4 0 0 6 1 6 0 1 0 1 5 5 3



ART	BARCODE	ST.	PREZZO
02 81 81	4006160101515		18,50

50 SACCHETTI 22X30CM P/MACCHINA
SOTTOVUOTO 028180 PROFICOOK

UV1	UV2	IMBALLO
1	6	1/6 PB



4 0 0 6 1 6 0 1 0 1 5 1 5



ART	BARCODE	ST.	PREZZO
02 81 82	4006160101522		29,50

50 SACCHETTI 28X40CM P/MACCHINA
SOTTOVUOTO 028180 PROFICOOK

UV1	UV2	IMBALLO
1	6	1/6 PB



4 0 0 6 1 6 0 1 0 1 5 2 2



ART	BARCODE	ST.	PREZZO
04 17 53	4004094232466		16,80

SET 3 FOGLI DI CERA D'API "MAJA"
18-25-33 CM WESTMARK

UV1	UV2	IMBALLO
1	3	1/3/24 HB



4 0 0 4 0 9 4 2 3 2 4 6 6



ART	BARCODE	ST.	PREZZO
04 49 14	4008871207999		5,15

5 SACCHETTI ARROSTO '2IN1' 35X43 CM
TOPPITS

UV1	UV2	IMBALLO
1	20	1/20 PB



4 0 0 8 8 7 1 2 0 7 9 9 9



ART	BARCODE	ST.	PREZZO
04 19 53	4004094520587		3,95

10 CLIPS CHIUDI SACCHETTO PP COLORI
ASSORTITI WESTMARK

UV1	UV2	IMBALLO
1	6	1/6/24 BC



4 0 0 4 0 9 4 5 2 0 5 8 7



ART	BARCODE	ST.	PREZZO
04 19 55	4004094521638		3,20

2 CLIPS CHIUDI SACCHETTO 'MAXI'ABS
COLORI ASSORTITI WESTMARK

UV1	UV2	IMBALLO
1	12	1/12/144 PH



4 0 0 4 0 9 4 5 2 1 6 3 8



ART	BARCODE	ST.	PREZZO
04 19 56	4004094521836		3,35

3 CLIPS CHIUDI SACCHETTO 'MINI'ABS
COLORI ASSORT: WESTMARK

UV1	UV2	IMBALLO
1	12	1/12/144 PH



4 0 0 4 0 9 4 5 2 1 8 3 6



ART	BARCODE	ST.	PREZZO
04 16 87	4004094232961		2,25

5 COPRISTOVIGLIE PE Ø 9/14/17/19/25 CM
WESTMARK

UV1	UV2	IMBALLO
1	30	1/30/300 HB



4 0 0 4 0 9 4 2 3 2 9 6 1



ART	BARCODE	ST.	PREZZO
04 16 85	8004537416855		6,50

SET 6 COPERCHI ROTONDI IN SILICONE MISURE ASSORTITE EVA

UV1	UV2	IMBALLO
1	3	1/3/24 HB



8 0 0 4 5 3 7 4 1 6 8 5 5



ART	BARCODE	ST.	PREZZO
04 35 70	7610859151438		5,95

CONTENITORE RETTANGOL 'SUNSHINE' PP 2,2L 20X13,5X16CM ROTHO

UV1	UV2	IMBALLO
1	3	1/3 AL



7 6 1 0 8 5 9 1 5 1 4 3 8



ART	BARCODE	ST.	PREZZO
04 35 71	7610859151445		7,65

CONTENITORE RETTANGOL 'SUNSHINE' PP 4,1L 20X13,5X27CM ROTHO

UV1	UV2	IMBALLO
1	3	1/3 AL



7 6 1 0 8 5 9 1 5 1 4 4 5



ART	BARCODE	ST.	PREZZO
04 35 01	7610859156013		4,00

ORGANIZER PER FRIGO 'LOFT' SMALL PS 1,6L 7,5X31X9CM ROTHO

UV1	UV2	IMBALLO
1	4	1/4 CL



7 6 1 0 8 5 9 1 5 6 0 1 3



ART	BARCODE	ST.	PREZZO
04 35 02	7610859156020		4,95

ORGANIZER PER FRIGO 'LOFT' MEDIUM PS 3,1L 14X31X9CM ROTHO

UV1	UV2	IMBALLO
1	4	1/4 CL



7 6 1 0 8 5 9 1 5 6 0 2 0



ART	BARCODE	ST.	PREZZO
04 35 03	7610859156037		6,35

ORGANIZER PER FRIGO 'LOFT' LARGE PS 5,0L 22X31X9CM ROTHO

UV1	UV2	IMBALLO
1	4	1/4 CL



7 6 1 0 8 5 9 1 5 6 0 3 7



ART	BARCODE	ST.	PREZZO
04 35 04	7610859168481		14,00

SET 3 ORGANIZER FRIGO LOFT 1,6 - 3,1 - 5,0 L ROTHO

UV1	UV2	IMBALLO
1	4	1/4 CL



7 6 1 0 8 5 9 1 6 8 4 8 1



ART	BARCODE	ST.	PREZZO
04 62 31	7610859221643		3,95

4 CONTENITORI FREEZER 'DOMINO' PP 0,22L 8X8X11,8 CM ROTHO

UV1	UV2	IMBALLO
1	6	1/6 SL



7 6 1 0 8 5 9 2 2 1 6 4 3



ART	BARCODE	ST.	PREZZO
04 62 32	7610859153258		3,45

4 CONTENITORI FREEZER 'DOMINO' PP 0,2L 11,7X7,5 CM ROTHO

UV1	UV2	IMBALLO
1	6	1/6 SL



7 6 1 0 8 5 9 1 5 3 2 5 8



ART	BARCODE	ST.	PREZZO
04 62 33	7610859221582		4,95

4 CONTENITORI FREEZER 'DOMINO' PP 0,5L 15,7X11,8 ROTHO

UV1	UV2	IMBALLO
1	6	1/6 SL



7 6 1 0 8 5 9 2 2 1 5 8 2



ART	BARCODE	ST.	PREZZO
04 62 34	7610859221599		5,40

4 CONTENITORI FREEZER 'DOMINO' PP 0,75L 15,7X11,8 CM ROTHO

UV1	UV2	IMBALLO
1	6	1/6 SL



7 6 1 0 8 5 9 2 2 1 5 9 9



ART	BARCODE	ST.	PREZZO
04 62 35	7610859221650		6,75

4 CONTENITORI FREEZER 'DOMINO' PP 1,0L 15,7X12 CM ROTHO

UV1	UV2	IMBALLO
1	6	1/6 SL



7 6 1 0 8 5 9 2 2 1 6 5 0



ART	BARCODE	ST.	PREZZO
04 62 36	7610859153302		6,95

3 CONTENITORI FREEZER 'DOMINO' PP 1,2L 23,3X11,8 ROTHO

UV1	UV2	IMBALLO
1	6	1/6 SL



7 6 1 0 8 5 9 1 5 3 3 0 2



ART	BARCODE	ST.	PREZZO
04 62 37	7610859153326		8,15

3 CONTENITORI FREEZER 'DOMINO' PP 1,5L 23,3X11,8 CM ROTHO

UV1	UV2	IMBALLO
1	6	1/6 SL



7 6 1 0 8 5 9 1 5 3 3 2 6



ART	BARCODE	ST.	PREZZO
04 35 66	7610859153012		5,10

CONTENITORE SPARGITORE 'DOMINO' PP 0,75L 16,5X9X10CM ROTHO

UV1	UV2	IMBALLO
1	6	1/6 AL



7 6 1 0 8 5 9 1 5 3 0 1 2



ART	BARCODE	ST.	PREZZO
04 35 67	7610859153029		5,70

CONTENITORE SPARGITORE 'DOMINO' PP 1,0L 16,5X9X13CM ROTHO

UV1	UV2	IMBALLO
1	6	1/6 AL



7 6 1 0 8 5 9 1 5 3 0 2 9



ART	BARCODE	ST.	PREZZO
04 35 68	7610859153036		6,60

CONTENITORE SPARGITORE 'DOMINO' PP 1,5L 16,5X9X19,5CM ROTHO

UV1	UV2	IMBALLO
1	6	1/6 AL



7 6 1 0 8 5 9 1 5 3 0 3 6



ART	BARCODE	ST.	PREZZO
04 17 05	7610859203199		8,25

BROCCA FRIGORIFERO 'FRESH' PP 2L 22X10X26 CM ROTHO

UV1	UV2	IMBALLO
1	3	1/3 AL



7 6 1 0 8 5 9 2 0 3 1 9 9



ART	BARCODE	ST.	PREZZO
04 62 01	7610859148940		4,55

CONTENITORE FRIGO 'CLIC&LOCK' PP 0,5L 16X12X6CM ROTHO

UV1	UV2	IMBALLO
1	6	1/6 CL



7 6 1 0 8 5 9 1 4 8 9 4 0



ART	BARCODE	ST.	PREZZO
04 62 02	7610859148957		4,95

CONTENITORE FRIGO 'CLIC&LOCK' PP 0,75L 16X12X8,5CM ROTHO

UV1	UV2	IMBALLO
1	4	1/4 CL



7 6 1 0 8 5 9 1 4 8 9 5 7



ART	BARCODE	ST.	PREZZO
04 62 03	7610859148964		5,50

CONTENITORE FRIGO 'CLIC&LOCK' PP 1L 16X12X11CM ROTHO

UV1	UV2	IMBALLO
1	4	1/4 CL



7 6 1 0 8 5 9 1 4 8 9 6 4



ART	BARCODE	ST.	PREZZO
04 62 08	7610859149008		8,30

CONTENITORE 'CLIC&LOCK' PP 2L 24X16X9CM ROTHO

UV1	UV2	IMBALLO
1	2	1/2 CL



7 6 1 0 8 5 9 1 4 9 0 0 8



ART	BARCODE	ST.	PREZZO
04 62 09	7610859149015		8,65

CONTENITORE 'CLIC&LOCK' PP 3L 24X16X13,6CM ROTHO

UV1	UV2	IMBALLO
1	2	1/2 CL



7 6 1 0 8 5 9 1 4 9 0 1 5



ART	BARCODE	ST.	PREZZO
04 62 04	7610859148971		6,10

CONTENITORE 'CLIC&LOCK' PP 0,8L 16X16X6CM ROTHO

UV1	UV2	IMBALLO
1	4	1/4 CL



7 6 1 0 8 5 9 1 4 8 9 7 1



ART	BARCODE	ST.	PREZZO
04 62 05	7610859148988		6,60

CONTENITORE FRIGO 'CLIC&LOCK' PP 1,4L 16X16X10CM ROTHO

UV1	UV2	IMBALLO
1	4	1/4 CL



7 6 1 0 8 5 9 1 4 8 9 8 8



ART	BARCODE	ST.	PREZZO
04 62 06	7610859148995		7,20

CONTENITORE 'CLIC&LOCK' PP 1L 24X16X5CM ROTHO

UV1	UV2	IMBALLO
1	4	1/4 CL



7 6 1 0 8 5 9 1 4 8 9 9 5



ART	BARCODE	ST.	PREZZO
04 62 07	7610859151674		7,75

CONTENITORE 'CLIC&LOCK' PP 1,5L 24x16x7CM ROTHO

UV1	UV2	IMBALLO
1	2	1/2 CL



7 6 1 0 8 5 9 1 5 1 6 7 4



ART	BARCODE	ST.	PREZZO
04 62 21	7610859221667		6,75

CONTENITORE FRIGO 2 SCOMPARTI 'RONDO' PP 24X16X11CM ROTHO

UV1	UV2	IMBALLO
1	4	1/4 AL



7 6 1 0 8 5 9 2 2 1 6 6 7



ART	BARCODE	ST.	PREZZO
04 62 11	7610859152213		2,85

2 CONTENITORI FRIGO 'RONDO' PP 0,07L 14,2X9,5X5,5 CM ROTHO

UV1	UV2	IMBALLO
1	6	1/6 SL



7 6 1 0 8 5 9 1 5 2 2 1 3



ART	BARCODE	ST.	PREZZO
04 62 16	7610859152787		2,95

CONTENITORE FRIGO RETTANG 'RONDO' PP 0,5L 16X12X5,3CM ROTHO

UV1	UV2	IMBALLO
1	6	1/6 AL



7 6 1 0 8 5 9 1 5 2 7 8 7



ART	BARCODE	ST.	PREZZO
04 62 17	7610859221773		3,15

CONTENITORE FRIGO RETT 'RONDO' PP 0,75L 16X12X7,5CM ROTHO

UV1	UV2	IMBALLO
1	6	1/6 AL



7 6 1 0 8 5 9 2 2 1 7 7 3



ART	BARCODE	ST.	PREZZO
04 62 18	7610859221780		3,60

CONTENIT. FRIGO RETTANG 'RONDO' PP 1,0L 16X12X9,5CM ROTHO

UV1	UV2	IMBALLO
1	6	1/6 AL



7 6 1 0 8 5 9 2 2 1 7 8 0



ART	BARCODE	ST.	PREZZO
04 62 19	7610859221797		4,95

CONTENITORE FRIGO RETTANG 'RONDO' PP 1,5L 24X16X7,5CM ROTHO

UV1	UV2	IMBALLO
1	6	1/6 AL



7 6 1 0 8 5 9 2 2 1 7 9 7



ART	BARCODE	ST.	PREZZO
04 62 12	7610859221704		1,65

CONTENITORE FRIGO RETTANG 'RONDO' PP 0,2L 12X8X5,5 CM ROTHO

UV1	UV2	IMBALLO
1	6	1/6 AL



7 6 1 0 8 5 9 2 2 1 7 0 4



ART	BARCODE	ST.	PREZZO
04 62 22	7610859221674		9,90

CONTENITORE FRIGO 3 SCOMPARTI 'RONDO' PP 24X16X11,5CM ROTHO

UV1	UV2	IMBALLO
1	4	1/4 AL



7 6 1 0 8 5 9 2 2 1 6 7 4



ART	BARCODE	ST.	PREZZO
04 62 40	7610859170071		5,20

MENU BOX 'MEMORY' VERDE PP 1L 16X15X8CM ROTHO

UV1	UV2	IMBALLO
1	5	1/5 SL



7 6 1 0 8 5 9 1 7 0 0 7 1



ART	BARCODE	ST.	PREZZO
04 62 20	7610859152824		5,50

CONTENIT. FRIGO RETTANG 'RONDO' PP
2,0L 24X16X9,7CM ROTHO

UV1	UV2	IMBALLO
1	6	1/6 AL



7 6 1 0 8 5 9 1 5 2 8 2 4



ART	BARCODE	ST.	PREZZO
04 62 14	7610859152244		9,35

CONTENITORE FRIGO RETT 'RONDO' PP
5,0L 31,5X24X10 CM ROTHO

UV1	UV2	IMBALLO
1	5	1/5 AL



7 6 1 0 8 5 9 1 5 2 2 4 4



ART	BARCODE	ST.	PREZZO
04 62 15	7610859221735		10,40

CONTENITORE FRIGO RETT 'RONDO' PP
8,0L 31,5x24x14,5 CM ROTHO

UV1	UV2	IMBALLO
1	2	1/2 AL



7 6 1 0 8 5 9 2 2 1 7 3 5



ART	BARCODE	ST.	PREZZO
04 62 13	7610859152237		5,35

CONTENITORE FRIGO RETT 'RONDO' PP
1,0L 24X16X5,3 CM ROTHO

UV1	UV2	IMBALLO
1	6	1/6 AL



7 6 1 0 8 5 9 1 5 2 2 3 7



ART	BARCODE	ST.	PREZZO
04 35 81	8004537435818		4,50

CONTENITORE FRIGO + COPERCHIO CON
VALVOLA VETRO/PP 370ML EVA

UV1	UV2	IMBALLO
1	3	1/3/24 SL



8 0 0 4 5 3 7 4 3 5 8 1 8



ART	BARCODE	ST.	PREZZO
04 35 82	8004537435825		5,50

CONTENITORE FRIGO + COPERCHIO CON
VALVOLA VETRO/PP 640ML EVA

UV1	UV2	IMBALLO
1	3	1/3/24 SL



8 0 0 4 5 3 7 4 3 5 8 2 5



ART	BARCODE	ST.	PREZZO
04 35 83	8004537435832		7,50

CONTENITORE FRIGO+COPERCHIO CON
VALVOLA VETRO/PP 1040ML EVA

UV1	UV2	IMBALLO
1	3	1/3/12 SL



8 0 0 4 5 3 7 4 3 5 8 3 2



ART	BARCODE	ST.	PREZZO
04 35 84	8004537435849		8,50

CONTENITORE FRIGO+COPERCHIO CON
VALVOLA VETRO/PP 1520ML EVA

UV1	UV2	IMBALLO
1	3	1/3/12 SL



8 0 0 4 5 3 7 4 3 5 8 4 9



ART	BARCODE	ST.	PREZZO
04 35 85	8004537435856		12,00

CONTENITORE 2
SCOMPARTI+COPERCHIO VETRO/PP
1380ML EVA

UV1	UV2	IMBALLO
1	3	1/3/12 SL



8 0 0 4 5 3 7 4 3 5 8 5 6



ART	BARCODE	ST.	PREZZO
04 35 87	8004537435870		16,50

SET 3 CONTENITORI FRIGO VETRO/PP
320 - 520 - 1200 ML EVA

UV1	UV2	IMBALLO
1	4	1/8 PB



8 0 0 4 5 3 7 4 3 5 8 7 0



ART	BARCODE	ST.	PREZZO
04 19 09	7610859207241	A	5,50

CONTENITORE PORTA 6 UOVA 1.25L PP
19.5X14.5X6.5 CM ROTHO

UV1	UV2	IMBALLO
1	5	1/5 SL



7 6 1 0 8 5 9 2 0 7 2 4 1



ART	BARCODE	ST.	PREZZO
04 17 28	4004094257476		3,50

4 BARATTOLI SPEZIE PER FRIGO 'TRIO'
PE 0,1 L WESTMARK

UV1	UV2	IMBALLO
1	4	1/12 PG



4 0 0 4 0 9 4 2 5 7 4 7 6



ART	BARCODE	ST.	PREZZO
04 17 29	4004094258473		4,25

4 BARATTOLI SPEZIE PER FRIGO 'TRIO' PE 0,2 L WESTMARK

UV1	UV2	IMBALLO
1	4	1/8 PG



4 0 0 4 0 9 4 2 5 8 4 7 3



ART	BARCODE	ST.	PREZZO
04 35 16	8593419204470		5,65

CONTENITORE CUCINA 'SMOKE' SIMAX VETRO 0,40L BOHEMIA

UV1	UV2	IMBALLO
1	6	1/6 BK



8 5 9 3 4 1 9 2 0 4 4 7 0



ART	BARCODE	ST.	PREZZO
04 35 17	8593419204418		5,80

CONTENITORE CUCINA 'SMOKE' SIMAX VETRO 0,90L BOHEMIA

UV1	UV2	IMBALLO
1	6	1/6 BK



8 5 9 3 4 1 9 2 0 4 4 1 8



ART	BARCODE	ST.	PREZZO
04 35 18	8593419204388		5,95

CONTENITORE CUCINA 'SMOKE' SIMAX VETRO 1,50L BOHEMIA

UV1	UV2	IMBALLO
1	6	1/6 BK



8 5 9 3 4 1 9 2 0 4 3 8 8



ART	BARCODE	ST.	PREZZO
04 35 19	8593419204364		6,15

CONTENITORE CUCINA 'SMOKE' SIMAX VETRO 2,00L BOHEMIA

UV1	UV2	IMBALLO
1	6	1/6 BK



8 5 9 3 4 1 9 2 0 4 3 6 4



ART	BARCODE	ST.	PREZZO
04 35 50	4000270380235		7,50

CONTENITORE IN VETRO+COPERCHIO BAMBU FSC Ø13X5.7 CM KESPER

UV1	UV2	IMBALLO
1	3	1/3/24 AL



4 0 0 0 2 7 0 3 8 0 2 3 5



ART	BARCODE	ST.	PREZZO
04 35 51	4000270380242		10,90

CONTENITORE IN VETRO+COPERCHIO BAMBU FSC Ø17X7 CM KESPER

UV1	UV2	IMBALLO
1	3	1/3/24 AL



4 0 0 0 2 7 0 3 8 0 2 4 2



ART	BARCODE	ST.	PREZZO
04 35 52	4000270380211		8,50

CONTENITORE IN VETRO+COPERCHIO BAMBU FSC 17X12X5.4 CM KESPER

UV1	UV2	IMBALLO
1	3	1/3/24 SP



4 0 0 0 2 7 0 3 8 0 2 1 1



ART	BARCODE	ST.	PREZZO
04 35 53	4000270380228		11,20

CONTENITORE IN VETRO+COPERCHIO BAMBU FSC 20X15X6 CM KESPER

UV1	UV2	IMBALLO
1	3	1/3/24 SP



4 0 0 0 2 7 0 3 8 0 2 2 8



ART	BARCODE	ST.	PREZZO
04 16 79	4004094237874		7,50

FUSTINO LATTE/ALIMENTI + COPERCCCHIO PE 2 L WESTMARK

UV1	UV2	IMBALLO
1	6	1/3/30 AL



4 0 0 4 0 9 4 2 3 7 8 7 4



ART	BARCODE	ST.	PREZZO
04 16 80	4004094237973		8,65

FUSTINO LATTE/ALIMENTI + COPERCCCHIO PE 3 L WESTMARK

UV1	UV2	IMBALLO
1	6	1/3/24 AL



4 0 0 4 0 9 4 2 3 7 9 7 3



ART	BARCODE	ST.	PREZZO
04 17 07	7610859030146		7,95

BIDONE ALIMENTI+COPERCHIO PP BIANCO 3L ROTHO

UV1	UV2	IMBALLO
1	4	1/4 BK



7 6 1 0 8 5 9 0 3 0 1 4 6



ART	BARCODE	ST.	PREZZO
04 16 78	9002427440026	A	4,60

BIDONCINO LATTE+COP BIANCO 2L / Ø13 X H20,5CM TEKO PLASTIC

UV1	UV2	IMBALLO
1	5	1/20 BK



9 0 0 2 4 2 7 4 4 0 0 2 6



ART	BARCODE	ST.	PREZZO
04 35 10	4004094623868	A	18,90

CONTENITORE CUCINA ACCIAIO INOSSIDABILE 2500ML WESTMARK

UV1	UV2	IMBALLO
1	2	1/2/12 PB



4 0 0 4 0 9 4 6 2 3 8 6 8



ART	BARCODE	ST.	PREZZO
04 35 40	4000753153608		7,60

CONTENITORE CUCINA VETRO SIMAX+COPERCHIO LEGNO 0,40L BOHEMIA

UV1	UV2	IMBALLO
1	6	1/6 BK



4 0 0 0 7 5 3 1 5 3 6 0 8



ART	BARCODE	ST.	PREZZO
04 35 41	4000753153592		7,75

CONTENITORE CUCINA VETRO SIMAX+COPERCHIO LEGNO 0,90L BOHEMIA

UV1	UV2	IMBALLO
1	6	1/6 BK



4 0 0 0 7 5 3 1 5 3 5 9 2



ART	BARCODE	ST.	PREZZO
04 35 42	4000753153585		7,90

CONTENITORE CUCINA VETRO SIMAX+COPERCHIO LEGNO 1,50L BOHEMIA

UV1	UV2	IMBALLO
1	6	1/6 BK



4 0 0 0 7 5 3 1 5 3 5 8 5



ART	BARCODE	ST.	PREZZO
04 35 43	4000753153578		8,10

CONTENITORE CUCINA VETRO SIMAX+COPERCHIO LEGNO 2,00L BOHEMIA

UV1	UV2	IMBALLO
1	6	1/6 BK



4 0 0 0 7 5 3 1 5 3 5 7 8



ART	BARCODE	ST.	PREZZO
09 19 28	8435011107592	A	5,20

VASO VETRO+TAPPO SUGHERO QUADRATO 500 CC

UV1	UV2	IMBALLO
1	6	1/6 BK



8 4 3 5 0 1 1 1 0 7 5 9 2



ART	BARCODE	ST.	PREZZO
09 19 01	8435011108391	A	1,70

VASO VETRO+TAPPO SUGHERO OTTAGONALE 38 CC

UV1	UV2	IMBALLO
6	24	1/24 BK



8 4 3 5 0 1 1 1 0 8 3 9 1



ART	BARCODE	ST.	PREZZO
09 19 02	8435011108070		1,70

VASO VETRO+TAPPO SUGHERO QUADRATO 30 CC

UV1	UV2	IMBALLO
6	24	1/24 BK



8 4 3 5 0 1 1 1 0 8 0 7 0



ART	BARCODE	ST.	PREZZO
09 19 03	8435011108285		1,70

VASO VETRO+TAPPO SUGHERO 2 MANICI 39 CC

UV1	UV2	IMBALLO
6	24	1/24 BK



8 4 3 5 0 1 1 1 0 8 2 8 5



ART	BARCODE	ST.	PREZZO
09 19 05	8435011107868	A	1,65

VASO VETRO+TAPPO SUGHERO BOMBATO 90 CC

UV1	UV2	IMBALLO
6	24	1/24 BK



8 4 3 5 0 1 1 1 0 7 8 6 8



ART	BARCODE	ST.	PREZZO
09 19 07	8435011107844		2,85

VASO VETRO+TAPPO SUGHERO ROTONDO 90 CC

UV1	UV2	IMBALLO
6	18	1/18 BK



8 4 3 5 0 1 1 1 0 7 8 4 4



ART	BARCODE	ST.	PREZZO
07 18 85	8011549000019		13,70

CUOCI-PANE TERRACOTTA
25X34,5X11CM - 3L

UV1	UV2	IMBALLO
1	6	1/1 PB



8 0 1 1 5 4 9 0 0 0 0 1 9



ART	BARCODE	ST.	PREZZO
07 18 86	8011549102287		12,50

CUOCI-POLLO TERRACOTTA
24,5X34X11,5CM - 3L

UV1	UV2	IMBALLO
1	6	1/1 PB



8 0 1 1 5 4 9 1 0 2 2 8 7



ART	BARCODE	ST.	PREZZO
04 32 45	4000270680151		22,50

PORTAPANE LEGNO FAGGIO FSC
30x20X15CM KESPER

UV1	UV2	IMBALLO
1	2	1/1 CL



4 0 0 0 2 7 0 6 8 0 1 5 1



ART	BARCODE	ST.	PREZZO
04 32 46	4000270680007		27,50

PORTAPANE LEGNO FAGGIO FSC
39X25X18CM KESPER

UV1	UV2	IMBALLO
1	2	1/1 SL



4 0 0 0 2 7 0 6 8 0 0 0 7



ART	BARCODE	ST.	PREZZO
04 32 47	4000270585814		32,00

PORTAPANE BAMBU FSC 36X20X14CM
KESPER

UV1	UV2	IMBALLO
1	4	1/1 SP



4 0 0 0 2 7 0 5 8 5 8 1 4



ART	BARCODE	ST.	PREZZO
04 32 48	4000270850905		21,90

PORTAPANE+COPERCHIO MELAMINA
BIANCO OPACO 34X14X18CM KESPER

UV1	UV2	IMBALLO
1	2	1/1 SP



4 0 0 0 2 7 0 8 5 0 9 0 5



ART	BARCODE	ST.	PREZZO
04 32 49	4000270850936		21,90

PORTAPANE+COPERCHIO MELAMINA
NERO OPACO 34X14X18CM KESPER

UV1	UV2	IMBALLO
1	2	1/1 SP



4 0 0 0 2 7 0 8 5 0 9 3 6



ART	BARCODE	ST.	PREZZO
04 32 41	4000270180415		20,90

PORTAPANE IN METALLO BLU 30X18X16
CM KESPER

UV1	UV2	IMBALLO
1	2	1/4 SL



4 0 0 0 2 7 0 1 8 0 4 1 5



ART	BARCODE	ST.	PREZZO
04 32 42	4000270180422		20,90

PORTAPANE IN METALLO BEIGE
30X18X16 CM KESPER

UV1	UV2	IMBALLO
1	2	1/4 SL



4 0 0 0 2 7 0 1 8 0 4 2 2



ART	BARCODE	ST.	PREZZO
04 41 36	7610859119322	A	6,80

BACINELLA MICROONDE 'MICRO
CLEVER' PP 0,4 L ROTHO

UV1	UV2	IMBALLO
1	6	1/6 AL



7 6 1 0 8 5 9 1 1 9 3 2 2



ART	BARCODE	ST.	PREZZO
04 41 35	7610859033062		3,70

COPERCHIO COPRI-PIATTO MICROONDE
Ø26.5CM ROTHO

UV1	UV2	IMBALLO
1	5	1/5 AL



7 6 1 0 8 5 9 0 3 3 0 6 2

Snocciolare Sterilizzare



ART	BARCODE	ST.	PREZZO
10 10 12	8004537010121		7,90

SNOCCIATORE CILIEGIE ACCIAIO INNOSSIDABILE EVA

UV1	UV2	IMBALLO
1	12	1/12/96 BC



8 0 0 4 5 3 7 0 1 0 1 2 1



ART	BARCODE	ST.	PREZZO
04 13 10	4004094400063		9,70

SNOCCIOLA CILIEGIE 'KERNEX' ALLUMINIO WESTMARK

UV1	UV2	IMBALLO
1	5	1/5/50 HB



4 0 0 4 0 9 4 4 0 0 0 6 3



ART	BARCODE	ST.	PREZZO
10 10 14	8004537010114	A	5,50

SNOCCIATORE CILIEGIE/OLIVE ALLUMINIO GRIGIO 19CM EVA

UV1	UV2	IMBALLO
1	6	1/6/48 CD



8 0 0 4 5 3 7 0 1 0 1 1 4



ART	BARCODE	ST.	PREZZO
04 13 11	4004094401060		15,20

SNOCCIOLA PRUGNE 'STEINEX' ALLUMINIO WESTMARK

UV1	UV2	IMBALLO
1	5	1/5/50 HB



4 0 0 4 0 9 4 4 0 1 0 6 0



ART	BARCODE	ST.	PREZZO
04 13 28	4004094404078		13,90

SNOCCIOLA OLIVE 'OLIVUS' ALLUMINIO WESTMARK

UV1	UV2	IMBALLO
1	5	1/5/50 CD



4 0 0 4 0 9 4 4 0 4 0 7 8



ART	BARCODE	ST.	PREZZO
10 10 11	4004094403569		25,20

SNOCCIOLA CILIEGIE 'KERNFIX' ABS/SAN/INOX WESTMARK

UV1	UV2	IMBALLO
1	3	1/3 PB



4 0 0 4 0 9 4 4 0 3 5 6 9



ART	BARCODE	ST.	PREZZO
10 10 16	4004094407062		40,90

SNOCCIOLA CILIEGIE 'KIRSCHOMAT' AL/SAN/INOX WESTMARK

UV1	UV2	IMBALLO
1	5	1/5 PB



4 0 0 4 0 9 4 4 0 7 0 6 2



ART	BARCODE	ST.	PREZZO
10 10 18	8004537010183		14,25

SNOCCIOLATORE CILIEGIE+VENTOSA EVA

UV1	UV2	IMBALLO
1	6	1/6/18 PB



8 0 0 4 5 3 7 0 1 0 1 8 3



ART	BARCODE	ST.	PREZZO
10 10 03	4004094105371		7,70

PINZA PRENDIVASI CROMATA PE/ABS WESTMARK

UV1	UV2	IMBALLO
1	5	1/5/40 CD



4 0 0 4 0 9 4 1 0 5 3 7 1



ART	BARCODE	ST.	PREZZO
10 10 04	8004537010046		10,40

IMBUTO MARPELLATA ACCIAIO INNOSSIDABILE 18/8 EVA

UV1	UV2	IMBALLO
1	12	1/12/36 HT



8 0 0 4 5 3 7 0 1 0 0 4 6



ART	BARCODE	ST.	PREZZO
10 10 05	4004094115073		3,95

IMBUTO GIGANTE PP Ø125/Ø 37 MM WESTMARK

UV1	UV2	IMBALLO
1	5	1/5/50 CD



4 0 0 4 0 9 4 1 1 5 0 7 3



ART	BARCODE	ST.	PREZZO
10 10 07	4004094115578		5,15

2 IMBUTI 'TWIX' PP WESTMARK

UV1	UV2	IMBALLO
1	12	1/3/12 CD



4 0 0 4 0 9 4 1 1 5 5 7 8



ART	BARCODE	ST.	PREZZO
04 13 99	4004094119361		6,80

TESSUTO PER FILTRARE PASSATI
60X60CM WESTMARK

UV1	UV2	IMBALLO
1	3	1/3/48 HB



4 0 0 4 0 9 4 1 1 9 3 6 1

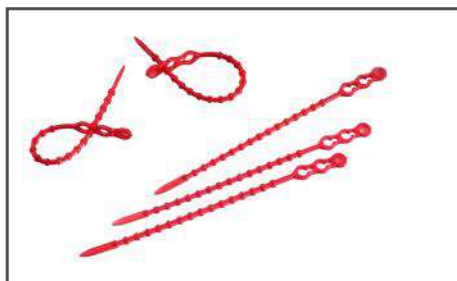

ART	BARCODE	ST.	PREZZO
10 10 21	4004094153938	H	3,95

50 FASCETTE PE WESTMARK

UV1	UV2	IMBALLO
1	12	1/6/60 PH



4 0 0 4 0 9 4 1 5 3 9 3 8



ART	BARCODE	ST.	PREZZO
10 10 24	4004094663871		2,10

BOTTIGLIA VETRO COLLO DIRITTO E
TAPPO A VITE 250 ML WESTMARK

UV1	UV2	IMBALLO
1	12	1/6 AL



4 0 0 4 0 9 4 6 6 3 8 7 1



ART	BARCODE	ST.	PREZZO
10 10 25	4004094663673		2,15

BOTTIGLIA VETRO COLLO DIRITTO E
TAPPO A VITE 350 ML WESTMARK

UV1	UV2	IMBALLO
1	6	1/6 AL



4 0 0 4 0 9 4 6 6 3 6 7 3



ART	BARCODE	ST.	PREZZO
10 10 26	4004094663475		2,30

BOTTIGLIA VETRO COLLO DIRITTO E
TAPPO A VITE 500 ML WESTMARK

UV1	UV2	IMBALLO
1	6	1/6 AL



4 0 0 4 0 9 4 6 6 3 4 7 5



ART	BARCODE	ST.	PREZZO
10 10 22	4004094663079		2,65

BOTTIGLIA VETRO TAPPO MECCANICO
QUADRATA 40ML IN DISPLAY WES

UV1	UV2	IMBALLO
24	48	1/24 DB



4 0 0 4 0 9 4 6 6 3 0 7 9



ART	BARCODE	ST.	PREZZO
10 10 28	4004094662874	A	3,25

BOTTIGLIA VETRO CON TAPPO
MECCANICO QUADRATA 250ML
WESTMARK

UV1	UV2	IMBALLO
1	6	1/6 AL



4 0 0 4 0 9 4 6 6 2 8 7 4



ART	BARCODE	ST.	PREZZO
10 10 30	4004094662072	A	4,40

BOTTIGLIA VETRO CON TAPPO
MECCANICO QUADRATA 1L WESTMARK

UV1	UV2	IMBALLO
1	6	1/6 AL



4 0 0 4 0 9 4 6 6 2 0 7 2



ART	BARCODE	ST.	PREZZO
10 10 29	4004094662478	A	3,70

BOTTIGLIA VETRO CON TAPPO
MECCANICO QUADRATA 500ML
WESTMARK

UV1	UV2	IMBALLO
1	6	1/6 AL



4 0 0 4 0 9 4 6 6 2 4 7 8



ART	BARCODE	ST.	PREZZO
10 10 23	4004094663376		2,70

BOTTIGLIA VETRO COLLO DIRITTO E
TAPPO A VITE 1,0L WESTMARK

UV1	UV2	IMBALLO
1	6	1/6 AL



4 0 0 4 0 9 4 6 6 3 3 7 6



ART	BARCODE	ST.	PREZZO
10 10 91	4004094664076		1,50

BOTTIGLIA VETRO+TAPPO A VITE PER
LATTE/SUCCO 250 ML WESTMARK

UV1	UV2	IMBALLO
1	6	1/6 AL



4 0 0 4 0 9 4 6 6 4 0 7 6



ART	BARCODE	ST.	PREZZO
10 10 92	4004094664175		1,90

BOTTIGLIA VETRO+TAPPO A VITE PER
LATTE/SUCCO 500 ML WESTMARK

UV1	UV2	IMBALLO
1	6	1/6 AL



4 0 0 4 0 9 4 6 6 4 1 7 5



ART	BARCODE	ST.	PREZZO
10 10 93	4004094664274		2,65

BOTTIGLIA VETRO+TAPPO A VITE PER LATTE/SUCCO 1,0L WESTMARK

UV1	UV2	IMBALLO
1	6	1/6 AL



4 0 0 4 0 9 4 6 6 4 2 7 4



ART	BARCODE	ST.	PREZZO
10 10 35	4004094669873		1,40

VASO IN VETRO CON COPERCHIO ROTONDO 230ML/Ø66MM WESTMARK

UV1	UV2	IMBALLO
1	12	1/6 AL



4 0 0 4 0 9 4 6 6 9 8 7 3



ART	BARCODE	ST.	PREZZO
10 13 29	5410767008693		0,80

VASO MARMELLATA ROTONDO+COPERCHIO 230ML-80MM

UV1	UV2	IMBALLO
6	18	1/6 SP



5 4 1 0 7 6 7 0 0 8 6 9 3



ART	BARCODE	ST.	PREZZO
10 13 30	5410767008709		0,90

VASO MARMELLATA ROTONDO+COPERCHIO 440ML-80MM

UV1	UV2	IMBALLO
6	18	1/6 SP



5 4 1 0 7 6 7 0 0 8 7 0 9



ART	BARCODE	ST.	PREZZO
10 10 36	4004094669576		1,75

VASO IN VETRO CON COPERCHIO ROTONDO 440ML/Ø82MM WESTMARK

UV1	UV2	IMBALLO
1	6	1/6 AL



4 0 0 4 0 9 4 6 6 9 5 7 6



ART	BARCODE	ST.	PREZZO
10 10 39	4004094409332	A	4,40

10 COPERCHI A VITE DECORATI Ø 58 MM WESTMARK

UV1	UV2	IMBALLO
1	5	1/10/120 PH



4 0 0 4 0 9 4 4 0 9 3 3 2



ART	BARCODE	ST.	PREZZO
10 10 41	4004094409134	A	4,90

10 COPERCHI A VITE DECORATI Ø 66 MM WESTMARK

UV1	UV2	IMBALLO
1	5	1/10/100 PH



4 0 0 4 0 9 4 4 0 9 1 3 4



ART	BARCODE	ST.	PREZZO
10 10 42	4004094409035	A	4,90

10 COPERCHI A VITE DECORATI Ø 82 MM WESTMARK

UV1	UV2	IMBALLO
1	5	1/10/60 PH



4 0 0 4 0 9 4 4 0 9 0 3 5



ART	BARCODE	ST.	PREZZO
10 10 19	4004094664878		8,70

6 VASI IN VETRO+COPERCHIO ANGOLATI 100ML/Ø53MM WESTMARK

UV1	UV2	IMBALLO
1	6	1/1 SL



4 0 0 4 0 9 4 6 6 4 8 7 8



ART	BARCODE	ST.	PREZZO
10 10 94	4004094668449	A	5,25

6 VASI IN VETRO+COPERCHIO ROTONDI 212M WESTMARK

UV1	UV2	IMBALLO
1	4	1/1 SP



4 0 0 4 0 9 4 6 6 8 4 4 9



ART	BARCODE	ST.	PREZZO
10 10 95	4004094668548	A	5,45

6 VASI IN VETRO+COPERCHIO ROTONDI 370ML WESTMARK

UV1	UV2	IMBALLO
1	4	1/1 SP



4 0 0 4 0 9 4 6 6 8 5 4 8



ART	BARCODE	ST.	PREZZO
10 10 96	4004094668647	A	5,80

4 VASI IN VETRO+COPERCHIO ROTONDI 720ML WESTMARK

UV1	UV2	IMBALLO
1	4	1/1 SP



4 0 0 4 0 9 4 6 6 8 6 4 7



ART	BARCODE	ST.	PREZZO
10 10 97	4004094409776		2,65

6 COPERCHI A VITE DECORATI Ø 63 MM WESTMARK

UV1	UV2	IMBALLO
1	5	1/5/60 PH



4 0 0 4 0 9 4 4 0 9 7 7 6



ART	BARCODE	ST.	PREZZO
10 10 98	4004094409677		2,65

6 COPERCHI A VITE DECORATI Ø 66 MM WESTMARK

UV1	UV2	IMBALLO
1	5	1/5/50 PH



4 0 0 4 0 9 4 4 0 9 6 7 7



ART	BARCODE	ST.	PREZZO
10 10 99	4004094409578		3,15

6 COPERCHI A VITE DECORATI Ø 83 MM WESTMARK

UV1	UV2	IMBALLO
1	5	1/5/30 PH



4 0 0 4 0 9 4 4 0 9 5 7 8



ART	BARCODE	ST.	PREZZO
09 19 38	8435456425374	A	8,90

VASO VETRO+TAPPO ERMETICO 'KLIK' 800 CC

UV1	UV2	IMBALLO
1	6	1/6 BK



8 4 3 5 4 5 6 4 2 5 3 7 4



ART	BARCODE	ST.	PREZZO
09 19 39	8435456425367	A	9,90

VASO VETRO+TAPPO ERMETICO 'KILK' 1100 CC

UV1	UV2	IMBALLO
1	6	1/6 BK



8 4 3 5 4 5 6 4 2 5 3 6 7



ART	BARCODE	ST.	PREZZO
10 13 35	4011162080904		1,10

VASO PER STERILIZZARE +COP.'MINI STURZ' VETRO 80ML Ø6CM WECK

UV1	UV2	IMBALLO
12	72	1/12 BK



4 0 1 1 1 6 2 0 8 0 9 0 4



ART	BARCODE	ST.	PREZZO
10 13 36	4011162761919		1,25

VASO PER STERILIZZARE+COP.'MINI STURZ' VETRO 140ML Ø6CM WECK

UV1	UV2	IMBALLO
12	48	1/12 BK



4 0 1 1 1 6 2 7 6 1 9 1 9



ART	BARCODE	ST.	PREZZO
10 13 37	4011162760929		1,30

VASO PER STERILIZZARE+COP.'MINI STURZ' VETRO 160ML Ø6CM WECK

UV1	UV2	IMBALLO
12	48	1/12 BK



4 0 1 1 1 6 2 7 6 0 9 2 9



ART	BARCODE	ST.	PREZZO
10 13 40	4011162900905		1,40

VASO PER STERILIZZARE +COP.'STURZFORM' VETRO 290ML Ø8CM WECK

UV1	UV2	IMBALLO
6	48	1/6 BK



4 0 1 1 1 6 2 9 0 0 9 0 5



ART	BARCODE	ST.	PREZZO
10 13 46	4011162762923		1,30

VASO PER STERILIZZARE+COP.'TULPENFORM' VETRO 220ML Ø6CM WECK

UV1	UV2	IMBALLO
12	48	1/12 BK



4 0 1 1 1 6 2 7 6 2 9 2 3



ART	BARCODE	ST.	PREZZO
10 13 47	4011162744936		1,65

VASO PER STERILIZZARE+COP.'TULPENFORM' VETRO 0,5L Ø10CM WECK

UV1	UV2	IMBALLO
6	12	1/6 BK



4 0 1 1 1 6 2 7 4 4 9 3 6



ART	BARCODE	ST.	PREZZO
10 13 48	4011162745933		1,90

VASO PER STERILIZZARE +COP.'TULPENFORM' VETRO 1L Ø10CM WECK

UV1	UV2	IMBALLO
6	12	1/6 BK



4 0 1 1 1 6 2 7 4 5 9 3 3



ART	BARCODE	ST.	PREZZO
10 13 52	4011162804906		0,70

RICAMBIO COPERCHIO VETRO WECK Ø10CM

UV1	UV2	IMBALLO
6	12	1/50 BK



4 0 1 1 1 6 2 8 0 4 9 0 6



ART	BARCODE	ST.	PREZZO
10 13 54	4011162902909		1,35

VASO PER STERILIZZARE +COP.'SCHMUCKFORM'VETRO 0,22L Ø6CM WECK

UV1	UV2	IMBALLO
12	24	1/12 BK



4 0 1 1 1 6 2 9 0 2 9 0 9



ART	BARCODE	ST.	PREZZO
10 13 55	4011162901902		1,75

VASO PER STERILIZZARE+COP.'SCHMUCKFORM'VETRO 560ML Ø8CM WECK

UV1	UV2	IMBALLO
6	12	1/6 BK



4 0 1 1 1 6 2 9 0 1 9 0 2



ART	BARCODE	ST.	PREZZO
10 13 56	4011162748903		2,60

VASO PER STERILIZZARE+COP.'SCHMUCKFORM'VETRO 1L Ø10CM WECK

UV1	UV2	IMBALLO
4	8	1/4 BK



4 0 1 1 1 6 2 7 4 8 9 0 3



ART	BARCODE	ST.	PREZZO
10 13 33*	4011162756908	H	0,95

VASO PER STERILIZZARE +COP.'MINI STURZ' VETRO 35ML Ø4CM WECK

UV1	UV2	IMBALLO
12	72	1/12 BK



4 0 1 1 1 6 2 7 5 6 9 0 8



ART	BARCODE	ST.	PREZZO
10 13 23	4011162080812	A	5,70

4 VASI PER STERILIZZARE+COP.'MINI STURZ' VETRO 80ML Ø6CM WEC

UV1	UV2	IMBALLO
1	4	1/1 SP



4 0 1 1 1 6 2 0 8 0 8 1 2



ART	BARCODE	ST.	PREZZO
10 13 24	4011162761810	A	6,00

4 VASI PER STERILIZZARE+COP.'MINI STURZ' VETRO 140ML Ø6CM WE

UV1	UV2	IMBALLO
1	4	1/1 SP



4 0 1 1 1 6 2 7 6 1 8 1 0



ART	BARCODE	ST.	PREZZO
10 13 25	4011162760813	A	6,75

4 VASI PER STERILIZZARE+COP.'MINI STURZ' VETRO 160ML Ø6CM WE

UV1	UV2	IMBALLO
1	4	1/1 SP



4 0 1 1 1 6 2 7 6 0 8 1 3



ART	BARCODE	ST.	PREZZO
10 13 38	4011162751606		1,55

VASO PER STERILIZZARE +COP.'STURZ' VETRO 200ML Ø8CM WECK

UV1	UV2	IMBALLO
12	48	1/12 BK



4 0 1 1 1 6 2 7 5 1 6 0 6



ART	BARCODE	ST.	PREZZO
10 13 26	4011162762817	A	7,20

4 VASI PER STERILIZZARE+COP.'MINI TULPE' VETRO 220ML Ø6CM WE

UV1	UV2	IMBALLO
1	4	1/1 SP



4 0 1 1 1 6 2 7 6 2 8 1 7



ART	BARCODE	ST.	PREZZO
10 13 50	4011162807914		0,60

RICAMBIO COPERCHIO VETRO WECK Ø6CM

UV1	UV2	IMBALLO
5	10	1/50 BK



4 0 1 1 1 6 2 8 0 7 9 1 4



ART	BARCODE	ST.	PREZZO
10 13 51	4011162808904		0,65

RICAMBIO COPERCHIO VETRO WECK Ø8CM

UV1	UV2	IMBALLO
5	10	1/50 BK



4 0 1 1 1 6 2 8 0 8 9 0 4



ART	BARCODE	ST.	PREZZO
10 13 01	4011162054110		1,65

10 GUARNIZIONI GOMMA VASI WECK Ø6CM (54X67MM) WECK

UV1	UV2	IMBALLO
1	50	1/10/100 PG



ART	BARCODE	ST.	PREZZO
10 13 13	4011162094109		1,95

10 GUARNIZIONI GOMMA VASI WECK Ø10CM (94X108MM) WECK

UV1	UV2	IMBALLO
1	50	1/50 PG



ART	BARCODE	ST.	PREZZO
10 13 02	4011162074118		1,90

10 GUARNIZIONI GOMMA VASI WECK Ø8CM (74X86MM) WECK

UV1	UV2	IMBALLO
1	50	1/100 PG



ART	BARCODE	ST.	PREZZO
10 13 12	4011162090552		3,40

12 MOLLE VASI WECK

UV1	UV2	IMBALLO
1	10	1/70 PG



ART	BARCODE	ST.	PREZZO
10 11 01	8717127000746		66,50

STERILIZZATORE 'WHE10' SMALTATO 29L WECK

UV1	UV2	IMBALLO
1	3	1/1 LB



ART	BARCODE	ST.	PREZZO
10 11 02	8717127000500		147,00

STERILIZZATORE ELETTR. 'WAT14' SMALTATO 29L Ø35CM 2000W WECK

UV1	UV2	IMBALLO
1	2	1/1 LB



ART	BARCODE	ST.	PREZZO
10 11 06	8717127000517		174,00

PENTOLA BRODO/BRULE' 'WAT14A' SMALTATO 29L Ø35CM 2000W WECK

UV1	UV2	IMBALLO
1	2	1/1 LB



ART	BARCODE	ST.	PREZZO
10 11 07	8717127000555		212,50

PENTOLA BRODO/BRULE' 'WAT24A' INOX 30L Ø35CM 1800W WECK

UV1	UV2	IMBALLO
1	2	1/1 LB



ART	BARCODE	ST.	PREZZO
10 11 16	4003244070002		9,15

TERMOMETRO PENTOLA STERILIZZARE

UV1	UV2	IMBALLO
1	10	1/10 BK



ART	BARCODE	ST.	PREZZO
10 12 10	8717127000753		7,70

GRIGLIA PLASTIFICATA 32 CM WECK

UV1	UV2	IMBALLO
1	6	1/30 SP



ART	BARCODE	ST.	PREZZO
10 12 16	4005643555975		89,50

ESTRATTORE SUCCHI ACCIAIO INOSSIDABILE INDUZIONE 8L/Ø26CM

UV1	UV2	IMBALLO
1	2	1/2 PB



Imbuti Colini



ART	BARCODE	ST.	PREZZO
04 05 03	7611264504093		10,60

COLAPASTA MEZZALUNA FLESSIBILE INOX 'FLEXINOX' 18-24CM MOHA

UV1	UV2	IMBALLO
1	12	1/12/48 HB



7 6 1 1 2 6 4 5 0 4 0 9 3



ART	BARCODE	ST.	PREZZO
04 05 08	8004537405088	A	10,40

COLATUTTO ACCIAIO INOSSIDABILE 18/8 Ø16CM EVA

UV1	UV2	IMBALLO
1	6	1/6/36 HT



8 0 0 4 5 3 7 4 0 5 0 8 8



ART	BARCODE	ST.	PREZZO
04 05 15	8004537405156		41,50

PASSABRODO ALBERGHIERO ACCIAIO INOSSIDABILE 18/8 26CM EVA

UV1	UV2	IMBALLO
1	4	1/4/16 HT



8 0 0 4 5 3 7 4 0 5 1 5 6



ART	BARCODE	ST.	PREZZO
04 05 28	9002427383026	A	2,50

COLAPASTA CON MANICO PE BIANCO Ø 20 X H 9 CM TEKO PLASTIK

UV1	UV2	IMBALLO
1	5	1/10 BK



9 0 0 2 4 2 7 3 8 3 0 2 6



ART	BARCODE	ST.	PREZZO
04 05 30	4004094212611		3,95

COLAPASTA PE Ø 26 H12 CM WESTMARK

UV1	UV2	IMBALLO
1	10	1/20 BK



4 0 0 4 0 9 4 2 1 2 6 1 1



ART	BARCODE	ST.	PREZZO
04 05 29	9002427420028	A	2,95

COLAPASTA PE-HD BIANCO Ø 30 X H15 CM TEKO PLASTIK

UV1	UV2	IMBALLO
1	5	1/10 BK



9 0 0 2 4 2 7 4 2 0 0 2 8



ART	BARCODE	ST.	PREZZO
04 05 46	8004537405460		13,90

COLAPASTA ACCIAIO INOSSIDABILE 20X10,5 CM EVA

UV1	UV2	IMBALLO
1	6	1/12 HT



8 0 0 4 5 3 7 4 0 5 4 6 0



ART	BARCODE	ST.	PREZZO
04 05 45	8004537405453		16,40

COLAPASTA ACCIAIO INOSSIDABILE 18/8 24X13CM EVA

UV1	UV2	IMBALLO
1	6	1/12 HT



8 0 0 4 5 3 7 4 0 5 4 5 3



ART	BARCODE	ST.	PREZZO
04 04 97	8004537404975	A	15,50

COLAPASTA ACCIAIO INOSSIDABILE Ø18CM EVA

UV1	UV2	IMBALLO
1	3	1/6/48 HT



8 0 0 4 5 3 7 4 0 4 9 7 5



ART	BARCODE	ST.	PREZZO
04 04 98	8004537404982	A	22,50

COLAPASTA ACCIAIO INOSSIDABILE Ø22CM EVA

UV1	UV2	IMBALLO
1	3	1/6/24 HT



8 0 0 4 5 3 7 4 0 4 9 8 2



ART	BARCODE	ST.	PREZZO
04 04 99	8004537404999	A	29,50

COLAPASTA ACCIAIO INOSSIDABILE Ø26CM EVA

UV1	UV2	IMBALLO
1	3	1/6/24 HT



8 0 0 4 5 3 7 4 0 4 9 9 9



ART	BARCODE	ST.	PREZZO
04 05 54	8004537405545		6,90

CIOTOLA COLATUTTO ACCIAIO INOSSIDABILE Ø 14 CM EVA

UV1	UV2	IMBALLO
1	6	1/6/24 HT



8 0 0 4 5 3 7 4 0 5 5 4 5



ART	BARCODE	ST.	PREZZO
04 05 55	8004537405552		7,25

**CIOTOLA COLATUTTO ACCIAIO
INOSSIDABILE Ø 16.5 CM EVA**

UV1	UV2	IMBALLO
1	6	1/6/24 HT



8 0 0 4 5 3 7 4 0 5 5 5 2



ART	BARCODE	ST.	PREZZO
04 05 56	8004537405569		8,50

**CIOTOLA COLATUTTO ACCIAIO
INOSSIDABILE Ø 20.5 CM EVA**

UV1	UV2	IMBALLO
1	6	1/6/24 HT



8 0 0 4 5 3 7 4 0 5 5 6 9



ART	BARCODE	ST.	PREZZO
04 05 57	8004537405576		9,60

**CIOTOLA COLATUTTO ACCIAIO
INOSSIDABILE Ø 23.5 CM EVA**

UV1	UV2	IMBALLO
1	6	1/6/24 HT



8 0 0 4 5 3 7 4 0 5 5 7 6



ART	BARCODE	ST.	PREZZO
04 05 58	8004537405583		11,00

**CIOTOLA COLATUTTO ACCIAIO
INOSSIDABILE Ø 25.5 CM EVA**

UV1	UV2	IMBALLO
1	6	1/6/24 HT



8 0 0 4 5 3 7 4 0 5 5 8 3



ART	BARCODE	ST.	PREZZO
04 05 59	8004537405590		14,10

**CIOTOLA COLATUTTO ACCIAIO
INOSSIDABILE Ø 28.5 CM EVA**

UV1	UV2	IMBALLO
1	6	1/6/24 HT



8 0 0 4 5 3 7 4 0 5 5 9 0



ART	BARCODE	ST.	PREZZO
04 05 97	8004537405972	H	11,50

**COLATUTTO RETTANGOLARE ACCIAIO
INOSSIDABILE 28X22X5 CM EVA**

UV1	UV2	IMBALLO
1	6	1/6/24 HT



8 0 0 4 5 3 7 4 0 5 9 7 2



ART	BARCODE	ST.	PREZZO
04 05 98	8004537405989	H	12,80

**COLATUTTO RETTANGOLARE ACCIAIO
INOSSIDABILE 33X25X5,5 CM EVA**

UV1	UV2	IMBALLO
1	6	1/6/24 HT



8 0 0 4 5 3 7 4 0 5 9 8 9



ART	BARCODE	ST.	PREZZO
04 05 99	8004537405996	H	14,00

**COLATUTTO RETTANGOLARE ACCIAIO
INOSSIDABILE 38X28X5,5 CM EVA**

UV1	UV2	IMBALLO
1	6	1/6/24 HT



8 0 0 4 5 3 7 4 0 5 9 9 6



ART	BARCODE	ST.	PREZZO
04 05 18	8004537405187		11,60

**COLATUTTO ESTENSIBILE ACCIAIO
INOSSIDAB. 18/8 29-43X19CM EVA**

UV1	UV2	IMBALLO
1	6	1/24 SL



8 0 0 4 5 3 7 4 0 5 1 8 7



ART	BARCODE	ST.	PREZZO
04 05 34	8004537405347		5,10

**COLINO ACCIAIO INOSSIDABILE 18/8 8CM
EVA**

UV1	UV2	IMBALLO
1	6	1/12/144 CD



8 0 0 4 5 3 7 4 0 5 3 4 7



ART	BARCODE	ST.	PREZZO
04 05 35	8004537405354		6,15

**PASSABRODO ACCIAIO INOSSIDABILE
18/8 10CM EVA**

UV1	UV2	IMBALLO
1	6	1/12/144 CD



8 0 0 4 5 3 7 4 0 5 3 5 4



ART	BARCODE	ST.	PREZZO
04 05 36	8004537405361		10,95

**PASSABRODO ACCIAIO INOSSIDABILE
18/8 12CM EVA**

UV1	UV2	IMBALLO
1	6	1/12/120 CD



8 0 0 4 5 3 7 4 0 5 3 6 1



ART	BARCODE	ST.	PREZZO
04 05 37	8004537405378		13,25

**PASSABRODO ACCIAIO INOSSIDABILE
18/8 14CM EVA**

UV1	UV2	IMBALLO
1	6	1/12/72 CD



8 0 0 4 5 3 7 4 0 5 3 7 8



ART	BARCODE	ST.	PREZZO
04 05 38	8004537405385		16,00

**PASSABRODO ACCIAIO INOSSIDABILE
18/8 16CM EVA**

UV1	UV2	IMBALLO
1	6	1/12/72 CD



8 0 0 4 5 3 7 4 0 5 3 8 5



ART	BARCODE	ST.	PREZZO
04 05 39	8004537405392		19,80

**PASSABRODO ACCIAIO INOSSIDABILE
18/8 18CM EVA**

UV1	UV2	IMBALLO
1	6	1/12/48 CD



8 0 0 4 5 3 7 4 0 5 3 9 2



ART	BARCODE	ST.	PREZZO
04 05 40	8004537405408		22,50

**PASSABRODO ACCIAIO INOSSIDABILE
18/8 20CM EVA**

UV1	UV2	IMBALLO
1	6	1/12/48 CD



8 0 0 4 5 3 7 4 0 5 4 0 8



ART	BARCODE	ST.	PREZZO
04 05 62	8004196108085		3,85

COLINO ACCIAIO INOSSIDABILE 18/8 8CM

UV1	UV2	IMBALLO
1	12	1/12/300 SL



8 0 0 4 1 9 6 1 0 8 0 8 5



ART	BARCODE	ST.	PREZZO
04 05 63	8004196108108		4,25

**PASSABRODO ACCIAIO INOSSIDABILE
18/8 10CM**

UV1	UV2	IMBALLO
1	12	1/12/300 SL



8 0 0 4 1 9 6 1 0 8 1 0 8



ART	BARCODE	ST.	PREZZO
04 05 64	8004196108122		6,25

**PASSABRODO ACCIAIO INOSSIDABILE
18/8 12CM**

UV1	UV2	IMBALLO
1	12	1/12/180 SL



8 0 0 4 1 9 6 1 0 8 1 2 2



ART	BARCODE	ST.	PREZZO
04 05 65	8004196108146		8,10

**PASSABRODO ACCIAIO INOSSIDABILE
18/8 14CM**

UV1	UV2	IMBALLO
1	12	1/12/180 SL



8 0 0 4 1 9 6 1 0 8 1 4 6



ART	BARCODE	ST.	PREZZO
04 05 66	8004196108160		9,80

**PASSABRODO ACCIAIO INOSSIDABILE
18/8 16CM**

UV1	UV2	IMBALLO
1	12	1/12/120 SL



8 0 0 4 1 9 6 1 0 8 1 6 0



ART	BARCODE	ST.	PREZZO
04 05 67	8004196108184		12,90

**PASSABRODO ACCIAIO INOSSIDABILE
18/8 18CM**

UV1	UV2	IMBALLO
1	6	1/6/96 SL



8 0 0 4 1 9 6 1 0 8 1 8 4



ART	BARCODE	ST.	PREZZO
04 05 86	8004537405866		2,85

**COLINO ACCIAIO INOSSIDABILE ø8CM
EVA**

UV1	UV2	IMBALLO
1	12	1/12/144 CD



8 0 0 4 5 3 7 4 0 5 8 6 6



ART	BARCODE	ST.	PREZZO
04 05 87	8004537405873		3,25

**PASSABRODO ACCIAIO INOSSIDABILE
ø10CM EVA**

UV1	UV2	IMBALLO
1	12	1/12/144 CD



8 0 0 4 5 3 7 4 0 5 8 7 3



ART	BARCODE	ST.	PREZZO
04 05 88	8004537405880		4,60

PASSABRODO ACCIAIO INOSSIDABILE
Ø12CM EVA

UV1	UV2	IMBALLO
1	12	1/6/72 CD



8 0 0 4 5 3 7 4 0 5 8 8 0



ART	BARCODE	ST.	PREZZO
04 05 89	8004537405897		5,50

PASSABRODO ACCIAIO INOSSIDABILE
Ø14CM EVA

UV1	UV2	IMBALLO
1	6	1/6/48 CD



8 0 0 4 5 3 7 4 0 5 8 9 7



ART	BARCODE	ST.	PREZZO
04 05 90	8004537405903		6,25

PASSABRODO ACCIAIO INOSSIDABILE
Ø16CM EVA

UV1	UV2	IMBALLO
1	6	1/6/48 CD



8 0 0 4 5 3 7 4 0 5 9 0 3



ART	BARCODE	ST.	PREZZO
04 05 91	8004537405910		7,15

PASSABRODO ACCIAIO INOSSIDABILE
Ø18CM EVA

UV1	UV2	IMBALLO
1	6	1/6/48 CD



8 0 0 4 5 3 7 4 0 5 9 1 0



ART	BARCODE	ST.	PREZZO
04 05 33	8004537405330		10,90

3 COLINI ACCIAIO INOSSIDABILE
Ø8-10-14CM EVA

UV1	UV2	IMBALLO
1	6	1/6 HT



8 0 0 4 5 3 7 4 0 5 3 3 0



ART	BARCODE	ST.	PREZZO
04 05 13	8004537405132		9,40

COLINO ACCIAIO INOSSIDABILE
PIATTO+MANICO PLASTICA 19CM EVA

UV1	UV2	IMBALLO
1	6	1/6/36 HT



8 0 0 4 5 3 7 4 0 5 1 3 2



ART	BARCODE	ST.	PREZZO
04 05 14	8004537405149		12,10

COLINO ACCIAIO INOSSIDABILE
PIATTO+MANICO PLASTICA 25CM EVA

UV1	UV2	IMBALLO
1	6	1/6/36 HT



8 0 0 4 5 3 7 4 0 5 1 4 9



ART	BARCODE	ST.	PREZZO
04 05 20	8004537405200		12,70

COLINO ACCIAIO INOSSIDABILE
PROFONDO PIATTO 22,5 CM EVA

UV1	UV2	IMBALLO
1	6	1/48 HT



8 0 0 4 5 3 7 4 0 5 2 0 0



ART	BARCODE	ST.	PREZZO
04 05 48	8004537405484		5,80

COLATUTTO OVALE ACCIAIO
INOSSIDABILE 22X18CM EVA

UV1	UV2	IMBALLO
1	6	1/6/24 HT



8 0 0 4 5 3 7 4 0 5 4 8 4



ART	BARCODE	ST.	PREZZO
04 05 49	8002521174002		20,70

COLATUTTO ACCIAIO INOSSIDABILE 18/8
18X24CM

UV1	UV2	IMBALLO
1	10	1/5/10 SL



8 0 0 2 5 2 1 1 7 4 0 0 2



ART	BARCODE	ST.	PREZZO
04 05 50	8002521158002		14,15

COLATUTTO STAGNATO 18X24 CM

UV1	UV2	IMBALLO
1	10	1/5/10 SL



8 0 0 2 5 2 1 1 5 8 0 0 2



ART	BARCODE	ST.	PREZZO
04 05 51	8004537405514	A	12,00

PASSABRODO ALBERGHIERO ACCIAIO
INOSSIDABILE 18/8 24CM EVA

UV1	UV2	IMBALLO
1	6	1/6/24 HT



8 0 0 4 5 3 7 4 0 5 5 1 4



ART	BARCODE	ST.	PREZZO
04 05 52	8004537405521	A	13,00

PASSABRODO ALBERGHIERO ACCIAIO INOSSIDABILE 18/8 28CM EVA

UV1	UV2	IMBALLO
1	6	1/6/24 HT



8 0 0 4 5 3 7 4 0 5 5 2 1



ART	BARCODE	ST.	PREZZO
04 05 53	8004537405538	A	15,80

PASSABRODO ALBERGHIERO ACCIAIO INOSSIDABILE 18/8 32CM EVA

UV1	UV2	IMBALLO
1	6	1/6/24 HT



8 0 0 4 5 3 7 4 0 5 5 3 8



ART	BARCODE	ST.	PREZZO
04 05 04	8004537405040	A	13,90

CHINOIS ACCIAIO INOSSIDABILE Ø 18 CM EVA

UV1	UV2	IMBALLO
1	6	1/6/12 HT



8 0 0 4 5 3 7 4 0 5 0 4 0



ART	BARCODE	ST.	PREZZO
04 05 05	8004537405057		17,40

CHINOIS ACCIAIO INOSSIDABILE Ø 20 CM EVA

UV1	UV2	IMBALLO
1	6	1/6/12 HT



8 0 0 4 5 3 7 4 0 5 0 5 7



ART	BARCODE	ST.	PREZZO
04 05 06	8004537405064		20,90

CHINOIS ACCIAIO INOSSIDABILE Ø 24.5 CM EVA

UV1	UV2	IMBALLO
1	6	1/6/12 HT



8 0 0 4 5 3 7 4 0 5 0 6 4



ART	BARCODE	ST.	PREZZO
04 05 69	8000355301298		2,80

PARASPRUZZI STAGNATO Ø29CM

UV1	UV2	IMBALLO
1	12	1/36 BK



8 0 0 0 3 5 5 3 0 1 2 9 8



ART	BARCODE	ST.	PREZZO
04 05 41	8002953001860		1,40

COLINO NYLON 8 CM

UV1	UV2	IMBALLO
1	12	1/12/36 BK



8 0 0 2 9 5 3 0 0 1 8 6 0



ART	BARCODE	ST.	PREZZO
04 05 42	8002953001877		2,10

PASSABRODO NYLON 10 CM

UV1	UV2	IMBALLO
1	12	1/12/36 BK



8 0 0 2 9 5 3 0 0 1 8 7 7



ART	BARCODE	ST.	PREZZO
04 05 43	8002953001884		2,40

PASSABRODO NYLON 12 CM

UV1	UV2	IMBALLO
1	12	1/12/36 BK



8 0 0 2 9 5 3 0 0 1 8 8 4



ART	BARCODE	ST.	PREZZO
04 05 44	8002953001891		2,85

PASSABRODO NYLON 14 CM

UV1	UV2	IMBALLO
1	12	1/12/36 BK



8 0 0 2 9 5 3 0 0 1 8 9 1



ART	BARCODE	ST.	PREZZO
04 16 41	8004537416411		6,50

IMBUTO ACCIAIO INOSSIDABILE 18/8 Ø10CM EVA

UV1	UV2	IMBALLO
1	12	1/12/48 HT



8 0 0 4 5 3 7 4 1 6 4 1 1



ART	BARCODE	ST.	PREZZO
04 16 43	8004537416435		8,20

IMBUTO ACCIAIO INOSSIDABILE 18/8 Ø12CM EVA

UV1	UV2	IMBALLO
1	12	1/12/48 HT



8 0 0 4 5 3 7 4 1 6 4 3 5



ART	BARCODE	ST.	PREZZO
04 19 22	4004094511714		3,05

3 IMPUTI PE Ø7/9/10,5 CM WESTMARK

UV1	UV2	IMBALLO
1	12	1/12 BK



4 0 0 4 0 9 4 5 1 1 7 1 4



ART	BARCODE	ST.	PREZZO
04 19 23	4009808487514		4,10

3 IMBUTI PP 9/11/13 CM BUCHSTEINER

UV1	UV2	IMBALLO
1	12	1/60 PG



4 0 0 9 8 0 8 4 8 7 5 1 4



ART	BARCODE	ST.	PREZZO
04 67 20	4028574012102		1,05

IMBUTO HD-PE Ø 8 CM SCHNEIDER

UV1	UV2	IMBALLO
1	6	1/12/108 BK



4 0 2 8 5 7 4 0 1 2 1 0 2



ART	BARCODE	ST.	PREZZO
04 67 21	4028574012119		1,55

IMBUTO HD-PE Ø 10 CM SCHNEIDER

UV1	UV2	IMBALLO
1	6	1/12/108 BK



4 0 2 8 5 7 4 0 1 2 1 1 9



ART	BARCODE	ST.	PREZZO
04 67 22	4028574012126		2,25

IMBUTO HD-PE Ø 12 CM SCHNEIDER

UV1	UV2	IMBALLO
1	6	1/12 BK



4 0 2 8 5 7 4 0 1 2 1 2 6



ART	BARCODE	ST.	PREZZO
04 67 23	4028574012133		3,30

IMBUTO HD-PE Ø 14 CM SCHNEIDER

UV1	UV2	IMBALLO
1	6	1/12 BK



4 0 2 8 5 7 4 0 1 2 1 3 3



ART	BARCODE	ST.	PREZZO
04 67 24	4028574012140		3,80

IMBUTO HD-PE Ø 16,4 CM SCHNEIDER

UV1	UV2	IMBALLO
1	6	1/12 BK



4 0 2 8 5 7 4 0 1 2 1 4 0

Altri Accessori Cucina



ART	BARCODE	ST.	PREZZO
01 40 06	8004537140064		7,10

**CUOCI VERDURA ACCIAIO INOSSIDABILE
24CM EVA**

UV1	UV2	IMBALLO
1	12	1/12/72 CD



8 0 0 4 5 3 7 1 4 0 0 6 4



ART	BARCODE	ST.	PREZZO
01 40 07	8004537140071		9,45

**CUOCI VERDURA ACCIAIO INOSSIDABILE
28CM EVA**

UV1	UV2	IMBALLO
1	12	1/12/48 CD



8 0 0 4 5 3 7 1 4 0 0 7 1



ART	BARCODE	ST.	PREZZO
01 40 11	8004196111177		1,70

SPACCAFIAMMA METALLO 17 CM

UV1	UV2	IMBALLO
1	25	1/25/200 CL



8 0 0 4 1 9 6 1 1 1 1 7 7



ART	BARCODE	ST.	PREZZO
01 40 12	8004196111207		1,75

SPACCAFIAMMA METALLO 20 CM

UV1	UV2	IMBALLO
1	25	1/25/200 CL



8 0 0 4 1 9 6 1 1 1 2 0 7



ART	BARCODE	ST.	PREZZO
01 40 13	8004196150015		1,70

2 RIDUTTORE FORNELLO CROMATI

UV1	UV2	IMBALLO
1	12	1/6/252 PH



8 0 0 4 1 9 6 1 5 0 0 1 5



ART	BARCODE	ST.	PREZZO
01 40 14	8009463099011		14,50

**DIFFUSORE UNIVERSALE INDUZIONE
INOX 14CM FRABOSK**

UV1	UV2	IMBALLO
1	6	1/12 CD



8 0 0 9 4 6 3 0 9 9 0 1 1



ART	BARCODE	ST.	PREZZO
01 40 15	8009463099028		18,90

**DIFFUSORE UNIVERSALE
INDUZIONEINOX 22,5CM FRABOSK**

UV1	UV2	IMBALLO
1	3	1/6 CD



8 0 0 9 4 6 3 0 9 9 0 2 8



ART	BARCODE	ST.	PREZZO
01 40 10	8009463099004		9,95

**DIFFUSORE UNIVERSALE INDUZIONE
INOX 12CM FRABOSK**

UV1	UV2	IMBALLO
1	12	1/12 CD



8 0 0 9 4 6 3 0 9 9 0 0 4



ART	BARCODE	ST.	PREZZO
01 40 16	8004196164005		6,95

4 SPACCAFIAMMA RETE 17/20 CM

UV1	UV2	IMBALLO
1	25	1/50 SP



8 0 0 4 1 9 6 1 6 4 0 0 5



ART	BARCODE	ST.	PREZZO
04 54 23	8004537454239		3,60

ACCENDIGAS FIAMMA EVA

UV1	UV2	IMBALLO
1	6	1/6/72 BC



8 0 0 4 5 3 7 4 5 4 2 3 9



ART	BARCODE	ST.	PREZZO
01 40 21	9003088903004		9,10

**PIASTRA SPACCAFIAMMA ALLUMINIO
Ø16CM**

UV1	UV2	IMBALLO
1	10	1/100 WB



9 0 0 3 0 8 8 9 0 3 0 0 4



ART	BARCODE	ST.	PREZZO
01 40 22	9003088904001		10,95

**PIASTRA SPACCAFIAMMA ALLUMINIO
Ø19CM**

UV1	UV2	IMBALLO
1	10	1/60 WB



9 0 0 3 0 8 8 9 0 4 0 0 1



ART	BARCODE	ST.	PREZZO
01 40 41	4008256080483		5,30

COPRI PIASTRA ACCIAIO INOSSIDABILE 16CM

UV1	UV2	IMBALLO
1	10	1/10 SP



4 0 0 8 2 5 6 0 8 0 4 8 3



ART	BARCODE	ST.	PREZZO
01 40 42	4008256080490		6,60

COPRI PIASTRA ACCIAIO INOSSIDABILE 20CM

UV1	UV2	IMBALLO
1	10	1/10 SP



4 0 0 8 2 5 6 0 8 0 4 9 0



ART	BARCODE	ST.	PREZZO
04 05 68	8004537405682		9,10

PARASPRUZZI ACCIAIO INOSSIDABILE Ø33CM EVA

UV1	UV2	IMBALLO
1	12	1/12/72 HT



8 0 0 4 5 3 7 4 0 5 6 8 2



ART	BARCODE	ST.	PREZZO
04 47 63	8004537447637		2,35

APRITUTTO SILICONE ASSORTITO Ø 15 CM EVA

UV1	UV2	IMBALLO
1	12	1/24/216 CD



8 0 0 4 5 3 7 4 4 7 6 3 7



ART	BARCODE	ST.	PREZZO
05 03 93	7611264816325		7,60

GUANTO ANTI-TAGLIO 'PROTECTO' IN PP MISURA M/L MOHA

UV1	UV2	IMBALLO
1	6	1/6/96 CD



7 6 1 1 2 6 4 8 1 6 3 2 5



ART	BARCODE	ST.	PREZZO
04 68 20	4028574014007		7,20

2 GUANTI DA FORNO IN COTONE SENZA POLSO 27 CM SCHNEIDER

UV1	UV2	IMBALLO
1	6	1/1 PG



4 0 2 8 5 7 4 0 1 4 0 0 7



ART	BARCODE	ST.	PREZZO
04 68 21	4028574014014		8,20

2 GUANTI DA FORNO IN COTONE POLSO CORTO 34 CM SCHNEIDER

UV1	UV2	IMBALLO
1	6	1/1 PG



4 0 2 8 5 7 4 0 1 4 0 1 4



ART	BARCODE	ST.	PREZZO
04 68 22	4028574014021		8,90

2 GUANTI DA FORNO IN COTONE POLSO LUNGO 40 CM SCHNEIDER

UV1	UV2	IMBALLO
1	6	1/1 PG



4 0 2 8 5 7 4 0 1 4 0 2 1



ART	BARCODE	ST.	PREZZO
04 68 25	4028574014069		27,00

2 GUANTI DA FORNO IN CUIOIO 45CM SCHNEIDER

UV1	UV2	IMBALLO
1	5	1/50 PG



4 0 2 8 5 7 4 0 1 4 0 6 9



ART	BARCODE	ST.	PREZZO
01 40 36	4004094156076		10,50

2 GUANTI FORNO ANTISCIVOLO NEOPRENE WESTMARK

UV1	UV2	IMBALLO
1	3	1/6/48 CD



4 0 0 4 0 9 4 1 5 6 0 7 6



ART	BARCODE	ST.	PREZZO
01 40 55	7611264816189		15,50

GUANTO FORNO NEOPRENE 'MAXI PROTECTOR' 30-38CM MOHA

UV1	UV2	IMBALLO
1	12	1/12/48 HT



7 6 1 1 2 6 4 8 1 6 1 8 9



ART	BARCODE	ST.	PREZZO
01 40 57	7611264816097		14,80

GUANTO SILICONE 'OVEN & BBQ' 40CM MOHA

UV1	UV2	IMBALLO
1	6	1/6/36 HT



7 6 1 1 2 6 4 8 1 6 0 9 7



ART	BARCODE	ST.	PREZZO
01 40 37	4004094156274		7,80

2 PRESINE ANTISCIVOLO NEOPRENE WESTMARK

UV1	UV2	IMBALLO
1	3	1/6/48 CD



4 0 0 4 0 9 4 1 5 6 2 7 4

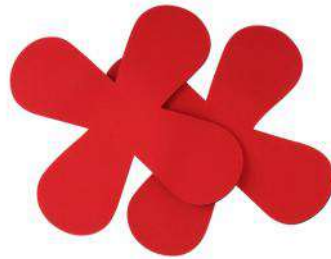

ART	BARCODE	ST.	PREZZO
01 40 45	7611264815106		7,50

2 SALVAPADELLE NEOPRENE 'PAN PROTECTOR' 24CM MOHA

UV1	UV2	IMBALLO
1	12	1/12/72 HB



7 6 1 1 2 6 4 8 1 5 1 0 6



ART	BARCODE	ST.	PREZZO
01 40 46	7611264815113		12,25

2 SALVAPADELLE NEOPRENE 'PAN PROTECTOR' 34CM MOHA

UV1	UV2	IMBALLO
1	12	1/12/72 HB



7 6 1 1 2 6 4 8 1 5 1 1 3



ART	BARCODE	ST.	PREZZO
04 37 60	8004537437607	A	3,95

SAPONE METALLICO ACCIAIO INOSSIDABILE EVA

UV1	UV2	IMBALLO
1	12	1/72 HB



8 0 0 4 5 3 7 4 3 7 6 0 7



ART	BARCODE	ST.	PREZZO
04 38 75	4004094521584		14,30

TERMOMETRO FRIGO DIGITALE ABS/PC/VETRO -20/+50°C WESTMARK

UV1	UV2	IMBALLO
1	6	1/6/30 DC



4 0 0 4 0 9 4 5 2 1 5 8 4



ART	BARCODE	ST.	PREZZO
04 38 31	4004036530209		3,05

TERMOMETRO FREEZER 53020 PLASTICA 21CM -40°/+40° KOCH

UV1	UV2	IMBALLO
1	10	1/20 HB



4 0 0 4 0 3 6 5 3 0 2 0 9



ART	BARCODE	ST.	PREZZO
04 38 88*	8004537438888	H	4,95

TERMOMETRO DA FORNO ACCIAIO INOSSIDABILE EVA

UV1	UV2	IMBALLO
1	6	1/12/96 PB



8 0 0 4 5 3 7 4 3 8 8 8 8



ART	BARCODE	ST.	PREZZO
04 38 60	8004537438604		33,50

TERMOMETRO DIGITALE AD INFRAROSSI -50°C - +520°C EVA

UV1	UV2	IMBALLO
1	6	1/6/48 PB



8 0 0 4 5 3 7 4 3 8 6 0 4



ART	BARCODE	ST.	PREZZO
04 39 10	7611264812990	A	9,40

TIMER DIGITALE CON CLIP 'NOMAD' MOHA

UV1	UV2	IMBALLO
1	6	1/6/24 DC



7 6 1 1 2 6 4 8 1 2 9 9 0



ART	BARCODE	ST.	PREZZO
04 39 00	4004094108884		8,40

TIMER DIGITALE CON MAGNETE WESTMARK

UV1	UV2	IMBALLO
1	6	1/6/30 DC



4 0 0 4 0 9 4 1 0 8 8 8 4



ART	BARCODE	ST.	PREZZO
04 39 20	8004537439205	A	9,90

TIMER DIGITALE NERO CON MAGNETE EVA

UV1	UV2	IMBALLO
1	5	1/100 HB



8 0 0 4 5 3 7 4 3 9 2 0 5



ART	BARCODE	ST.	PREZZO
04 39 12	4004094109188		15,50

TIMER DIGITALE CON MAGNETE "BIG" WESTMARK

UV1	UV2	IMBALLO
1	3	1/3/24 DC



4 0 0 4 0 9 4 1 0 9 1 8 8



ART	BARCODE	ST.	PREZZO
04 39 19	8004537439199		5,20

TIMER DIGITALE BIANCO CON MAGNETE EVA

UV1	UV2	IMBALLO
1	10	1/100 PB



ART	BARCODE	ST.	PREZZO
04 39 11	4004094109263		12,90

TIMER CON MAGNETE "REDONDO" WESTMARK

UV1	UV2	IMBALLO
1	3	1/3/24 HB



ART	BARCODE	ST.	PREZZO
04 39 21	8004537439212		3,50

CONTAMINUTI 'QUADRATO' PLASTICA EVA

UV1	UV2	IMBALLO
1	5	1/25/100 DC



ART	BARCODE	ST.	PREZZO
04 39 24	8004537439243		4,20

CONTAMINUTI 'UOVO' ASSORTITO EVA

UV1	UV2	IMBALLO
1	6	1/24/96 DC



ART	BARCODE	ST.	PREZZO
04 39 27	8004537439274		4,50

CONTAMINUTI 'GALLO' PLASTICA EVA

UV1	UV2	IMBALLO
1	5	1/25/100 DC



ART	BARCODE	ST.	PREZZO
04 39 28	8004537439281	H	3,60

CONTAMINUTI 'UOVO' EVA

UV1	UV2	IMBALLO
1	5	1/25/100 DC



ART	BARCODE	ST.	PREZZO
04 39 29	8004537439298	H	4,75

CONTAMINUTI 'MUCCA' PLASTICA EVA

UV1	UV2	IMBALLO
1	5	1/25/100 DC



ART	BARCODE	ST.	PREZZO
04 39 31	8004537439311		4,20

CONTAMINUTI 'POMODORO' PLASTICA EVA

UV1	UV2	IMBALLO
1	5	1/25/100 DC



ART	BARCODE	ST.	PREZZO
04 39 32	8004537439328	H	3,95

CONTAMINUTI 'LIMONE' PLASTICA EVA

UV1	UV2	IMBALLO
1	5	1/25/100 DC



ART	BARCODE	ST.	PREZZO
04 39 33	8004537439335	H	3,10

CONTAMINUTI 'PERA' PLASTICA EVA

UV1	UV2	IMBALLO
1	5	1/25/100 DC

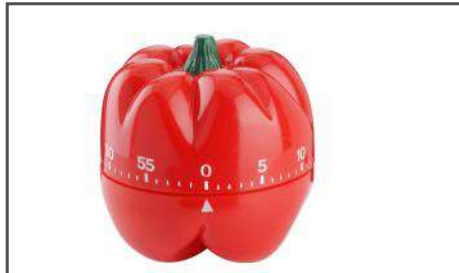
ART	BARCODE	ST.	PREZZO
04 39 37	8004537439373	H	3,95

CONTAMINUTI 'PEPERONE' ROSSO PLASTICA

UV1	UV2	IMBALLO
1	5	1/25/100 DC



ART	BARCODE	ST.	PREZZO
04 39 45	8004537439458		4,95

CONTAMINUTI 'CUOCO' PLASTICA EVA

UV1	UV2	IMBALLO
1	5	1/25/100 DC





ART	BARCODE	ST.	PREZZO
04 39 53	8004537439533		5,50

**CONTAMINUTI QUADRATO ACCIAIO
INOSSIDABILE EVA**

UV1	UV2	IMBALLO
1	5	1/25/100 PV



8 0 0 4 5 3 7 4 3 9 5 3 3



ART	BARCODE	ST.	PREZZO
04 39 54	8004537439540		6,60

**CONTAMINUTI MELA ACCIAIO
INOSSIDABILE EVA**

UV1	UV2	IMBALLO
1	5	1/25/100 PV



8 0 0 4 5 3 7 4 3 9 5 4 0



ART	BARCODE	ST.	PREZZO
04 39 83	8004537439830		6,60

**CONTAMINUTI 'UOVO' ACCIAIO
INOSSIDABILE EVA**

UV1	UV2	IMBALLO
1	5	1/25/100 PV



8 0 0 4 5 3 7 4 3 9 8 3 0



ART	BARCODE	ST.	PREZZO
04 05 84	4004094243240		14,95

**CENTRIFUGA INSALATA 'FORTUNA' PP
5L WESTMARK**

UV1	UV2	IMBALLO
1	3	1/6 SP



4 0 0 4 0 9 4 2 4 3 2 4 0



ART	BARCODE	ST.	PREZZO
04 05 80	7610859148476		13,75

**CENTRIFUGA INSALATA 'FRESH' PP 4,5L
Ø25CM ROTHO**

UV1	UV2	IMBALLO
1	5	1/1 PG



7 6 1 0 8 5 9 1 4 8 4 7 6



ART	BARCODE	ST.	PREZZO
04 05 93	7611264104057		34,00

**CENTRIFUGA INSALATA 'TURBY' BIANCO
Ø24CM MOHA**

UV1	UV2	IMBALLO
1	6	1/6 PB



7 6 1 1 2 6 4 1 0 4 0 5 7



ART	BARCODE	ST.	PREZZO
04 15 99	8004537415995		7,70

**PORTA ROTOLO CUCINA ACCIAIO
INOSSIDABILE SATINATO EVA**

UV1	UV2	IMBALLO
1	12	1/24 PB



8 0 0 4 5 3 7 4 1 5 9 9 5



ART	BARCODE	ST.	PREZZO
07 25 34	4000270812033		8,50

**PORTAROTOLI BAMBU' FSC Ø 14 X 32,5
CM KESPER**

UV1	UV2	IMBALLO
1	4	1/4 SL



4 0 0 0 2 7 0 8 1 2 0 3 3



ART	BARCODE	ST.	PREZZO
04 32 72	4000270280412		18,80

**PORTAROTOLI 3 SCOMPARTI ACACIA
FSC 42X19X5,4 CM KESPER**

UV1	UV2	IMBALLO
1	4	1/4 SL



4 0 0 0 2 7 0 2 8 0 4 1 2



ART	BARCODE	ST.	PREZZO
04 20 49	4006501257239		32,50

**PORTAROTOLI PLUS SENZA ROTOLI
PLASTICA LEIFHEIT**

UV1	UV2	IMBALLO
1	5	1/5 PB



4 0 0 6 5 0 1 2 5 7 2 3 9



ART	BARCODE	ST.	PREZZO
04 54 30	8004537454307		1,45

**2 FILTRO LAVANDINO ACCIAIO
INOSSIDABILE 7 CM EVA**

UV1	UV2	IMBALLO
1	6	1/6/300 BC



8 0 0 4 5 3 7 4 5 4 3 0 7

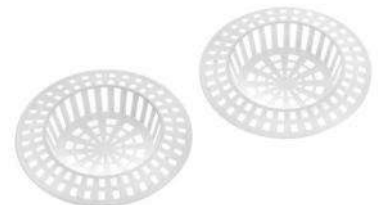

ART	BARCODE	ST.	PREZZO
04 19 50	4004094520778		1,60

**2 FILTRO SCARICO LAVANDINO PP Ø 7
CM WESTMARK**

UV1	UV2	IMBALLO
1	10	1/10/50 CD



4 0 0 4 0 9 4 5 2 0 7 7 8



ART	BARCODE	ST.	PREZZO
04 19 43	4004094518065		5,45

SPAZZOLINO FUNGHI 'CHAMPY' PS/PA Ø 6 CM WESTMARK

UV1	UV2	IMBALLO
1	5	1/5/25 HB



4 0 0 4 0 9 4 5 1 8 0 6 5



ART	BARCODE	ST.	PREZZO
04 17 37	7610859152053		4,95

4 FORME GHIACCIOLI 'WAVE' PP 0,75 L 14,5X6X12 CM ROTHO

UV1	UV2	IMBALLO
1	4	1/4 PH



7 6 1 0 8 5 9 1 5 2 0 5 3



ART	BARCODE	ST.	PREZZO
04 19 75	8004537419757		1,10

DOSATORE CONDIMENTI TRASPARENTE 15CM/290ML EVA

UV1	UV2	IMBALLO
6	12	6/12/144 CT



8 0 0 4 5 3 7 4 1 9 7 5 7



ART	BARCODE	ST.	PREZZO
04 19 86	8004537419863		1,50

DOSATORE CONDIMENTI GIALLO 17CM/410ML EVA

UV1	UV2	IMBALLO
6	12	6/12/144 CT



8 0 0 4 5 3 7 4 1 9 8 6 3



ART	BARCODE	ST.	PREZZO
04 19 87	8004537419870	A	1,30

DOSATORE CONDIMENTI ROSSO 17CM/410ML EVA

UV1	UV2	IMBALLO
6	12	6/12/144 CT



8 0 0 4 5 3 7 4 1 9 8 7 0



ART	BARCODE	ST.	PREZZO
04 19 88	8004537419887		1,50

DOSATORE CONDIMENTI TRASPAR 17CM/410ML EVA

UV1	UV2	IMBALLO
6	12	6/12/144 CT



8 0 0 4 5 3 7 4 1 9 8 8 7



ART	BARCODE	ST.	PREZZO
04 19 91	8004537419917		2,10

DOSATORE CONDIMENTI TRASPARENTE 21CM/720ML EVA

UV1	UV2	IMBALLO
6	12	6/12/72 CT



8 0 0 4 5 3 7 4 1 9 9 1 7

Carne Pesce Crostacei



ART	BARCODE	ST.	PREZZO
02 16 29	4019889136386		6,55

STAMPO HAMBURGER 'SIZE S' Ø 7,3 CM LURCH

UV1	UV2	IMBALLO
1	6	1/6/24 PB



4 0 1 9 8 8 9 1 3 6 3 8 6



ART	BARCODE	ST.	PREZZO
02 16 30	4019889134900		13,70

STAMPO HAMBURGER 'SIZE M+L' 3 PEZZI Ø 9,3+10,8 CM LURCH

UV1	UV2	IMBALLO
1	6	1/6/18 PB



4 0 1 9 8 8 9 1 3 4 9 0 0



ART	BARCODE	ST.	PREZZO
04 10 08	4019889134719		15,30

FORMA 6 PANINI HAMBURGER 'SIZE L - FLEXIFORM' SILICONE LURCH

UV1	UV2	IMBALLO
1	6	1/6/24 PB



4 0 1 9 8 8 9 1 3 4 7 1 9



ART	BARCODE	ST.	PREZZO
02 16 24	8004537216240		6,95

STAMPO HAMBURGER ALLUMINIO/PP Ø12CM EVA

UV1	UV2	IMBALLO
1	6	1/6/48 PB



8 0 0 4 5 3 7 2 1 6 2 4 0



ART	BARCODE	ST.	PREZZO
02 16 21	8004537216219		5,15

STAMPO HAMBURGER ALLUMINIO 9,5CM EVA

UV1	UV2	IMBALLO
1	12	1/12/72 BC



8 0 0 4 5 3 7 2 1 6 2 1 9



ART	BARCODE	ST.	PREZZO
02 16 22	4004094623363		9,90

STAMPO HAMBURGER ABS WESTMARK

UV1	UV2	IMBALLO
1	4	1/4/24 PB



4 0 0 4 0 9 4 6 2 3 3 6 3



ART	BARCODE	ST.	PREZZO
02 25 09*	4003244050059	H	3,50

ACCESSORIO BISCOTTI TRITACARNE NR.5

UV1	UV2	IMBALLO
1	5	1/10/200 BC



4 0 0 3 2 4 4 0 5 0 0 5 9



ART	BARCODE	ST.	PREZZO
02 25 11*	4003244050103	H	3,50

ACCESSORIO BISCOTTI TRITACARNE NR.10

UV1	UV2	IMBALLO
1	5	1/10/200 BC



4 0 0 3 2 4 4 0 5 0 1 0 3



ART	BARCODE	ST.	PREZZO
02 25 41	4004094975066		35,50

TRITACARNE GHISA MISURA 5, FORI Ø 4,5 MM WESTMARK

UV1	UV2	IMBALLO
1	6	1/6 PB



4 0 0 4 0 9 4 9 7 5 0 6 6



ART	BARCODE	ST.	PREZZO
02 25 42	4004094975264		41,70

TRITACARNE GHISA MISURA 8 WESTMARK

UV1	UV2	IMBALLO
1	4	1/4 PB



4 0 0 4 0 9 4 9 7 5 2 6 4



ART	BARCODE	ST.	PREZZO
02 25 46	4004094977763		127,00

TRITACARNE PP/ACCIAIO INOSSIDABILE DISCO Ø 8 MM WESTMARK

UV1	UV2	IMBALLO
1	2	1/4 PB



4 0 0 4 0 9 4 9 7 7 7 6 3



ART	BARCODE	ST.	PREZZO
02 25 45	4005643588423	A	33,00

TRITACARNE ALLUMINIO DISCO Ø 8 MM GSW

UV1	UV2	IMBALLO
1	3	1/3 PB



4 0 0 5 6 4 3 5 8 8 4 2 3



ART	BARCODE	ST.	PREZZO
02 25 51	8004537225518		20,50

TRITACARNE GHISA MISURA 5, FORI Ø 4,5 MM EVA

UV1	UV2	IMBALLO
1	8	1/8 PB



8 0 0 4 5 3 7 2 2 5 5 1 8



ART	BARCODE	ST.	PREZZO
02 25 52	8004537225525		24,00

TRITACARNE GHISA MISURA 8, FORI Ø 4,5 MM EVA

UV1	UV2	IMBALLO
1	6	1/6 PB



8 0 0 4 5 3 7 2 2 5 5 2 5



ART	BARCODE	ST.	PREZZO
02 25 53	8004537225532		29,50

TRITACARNE GHISA 10-4,5MM EVA

UV1	UV2	IMBALLO
1	4	1/4 PB



8 0 0 4 5 3 7 2 2 5 5 3 2



ART	BARCODE	ST.	PREZZO
02 25 57	4004094149337	A	8,30

3 IMBUTI INSACCATI PER TRITACARNE PE DISCO NR 5 WESTMARK

UV1	UV2	IMBALLO
1	6	1/6/48 PH



4 0 0 4 0 9 4 1 4 9 3 3 7



ART	BARCODE	ST.	PREZZO
02 25 58	4004094149436	A	8,70

3 IMBUTI INSACCATI PER TRITACARNE PE DISCO NR.8 WESTMARK

UV1	UV2	IMBALLO
1	6	1/6/48 PH



4 0 0 4 0 9 4 1 4 9 4 3 6



ART	BARCODE	ST.	PREZZO
02 25 59	4004094149535	A	9,10

3 IMBUTI INSACCATI PER TRITACARNE PE DISCO NR.10 WESTMARK

UV1	UV2	IMBALLO
1	6	1/6/48 PH



4 0 0 4 0 9 4 1 4 9 5 3 5



ART	BARCODE	ST.	PREZZO
04 13 85	4004094614286		13,60

SIRINGA PER ARROSTI E MARINATURE PP/INOX WESTMARK

UV1	UV2	IMBALLO
1	4	1/4/24 DC



4 0 0 4 0 9 4 6 1 4 2 8 6



ART	BARCODE	ST.	PREZZO
04 13 82	4004094152573		7,30

SIRINGA PER ARROSTI PP WESTMARK

UV1	UV2	IMBALLO
1	5	1/5/35 CD



4 0 0 4 0 9 4 1 5 2 5 7 3



ART	BARCODE	ST.	PREZZO
04 06 71	4004094152368		4,35

SPAGO ALIMENTARE 2 ROTOLI DA 60 M WESTMARK

UV1	UV2	IMBALLO
1	4	1/4/32 HB



4 0 0 4 0 9 4 1 5 2 3 6 8



ART	BARCODE	ST.	PREZZO
04 06 70	4004094102271		1,50

10 SPIEDINI PER INVOLTINI ACCIAIO INOX 10 CM WESTMARK

UV1	UV2	IMBALLO
1	10	1/10/60 CD



4 0 0 4 0 9 4 1 0 2 2 7 1



ART	BARCODE	ST.	PREZZO
04 06 69	4004094126871		3,10

AGO DA CUCINA ACCIAIO INOSSIDABILE 18 CM WESTMARK

UV1	UV2	IMBALLO
1	10	1/10/100 CD



4 0 0 4 0 9 4 1 2 6 8 7 1



ART	BARCODE	ST.	PREZZO
04 06 75	4004094126772		4,30

AGO PER LARDELLARE ACCIAIO INOSSIDABILE 19 CM WESTMARK

UV1	UV2	IMBALLO
1	5	1/5/150 CD



4 0 0 4 0 9 4 1 2 6 7 7 2



ART	BARCODE	ST.	PREZZO
04 18 99	8004537418996		13,20

PINZA ARROSTO ACCIAIO INOSSIDABILE 25CM EVA

UV1	UV2	IMBALLO
1	12	1/12/48 HB



8 0 0 4 5 3 7 4 1 8 9 9 6



ART	BARCODE	ST.	PREZZO
04 38 87	8004537438871		4,20

TERMOMETRO CARNE ACCIAIO INOSSIDABILE EVA

UV1	UV2	IMBALLO
1	6	1/12/96 BC



8 0 0 4 5 3 7 4 3 8 8 7 1



ART	BARCODE	ST.	PREZZO
02 81 85*	4006160103915		14,50

TERMOMETRO DIGITALE ARROSTI 'DHT1039' -45°/200°C PROFICOOK

UV1	UV2	IMBALLO
1	6	1/12 HB



4 0 0 6 1 6 0 1 0 3 9 1 5



ART	BARCODE	ST.	PREZZO
04 38 78	4004094127885		19,30

TERMOMETRO A SONDA DIGITALE 0/200°C WESTMARK

UV1	UV2	IMBALLO
1	6	1/12/30 DC



4 0 0 4 0 9 4 1 2 7 8 8 5



ART	BARCODE	ST.	PREZZO
04 38 90	8004537438901		12,00

TERMOMETRO DIGITALE A SONDA 20CM -50°/+200° EVA

UV1	UV2	IMBALLO
1	4	1/12/144 SC



8 0 0 4 5 3 7 4 3 8 9 0 1



ART	BARCODE	ST.	PREZZO
04 38 76	4004094129186		22,40

TERMOMETRO ARROSTI DIGITALE +SONDA 0/250°C WESTMARK

UV1	UV2	IMBALLO
1	6	1/12/30 DC



4 0 0 4 0 9 4 1 2 9 1 8 6



ART	BARCODE	ST.	PREZZO
04 06 99	8004537406993		3,60

PINZA TOGLI-LISCHE ACCIAIO INOSSIDABILE 12CM EVA

UV1	UV2	IMBALLO
1	20	1/20/200 CD



8 0 0 4 5 3 7 4 0 6 9 9 3



ART	BARCODE	ST.	PREZZO
04 13 26	4004094660887		11,20

PINZA LEVA LISCHE ACCIAIO INOSSIDABILE 14 CM WESTMARK

UV1	UV2	IMBALLO
1	6	1/6/72 BC



4 0 0 4 0 9 4 6 6 0 8 8 7



ART	BARCODE	ST.	PREZZO
04 13 27*	4004094650062		14,95

SQUAMA PESCE SCALEX ALLUMINIO/ACCIAIO INOSSIDABILE WESTMARK

UV1	UV2	IMBALLO
1	5	1/5/65 HB



4 0 0 4 0 9 4 6 5 0 0 6 2



ART	BARCODE	ST.	PREZZO
05 28 05	7611264255032		9,80

FORBICE PER CROSTACEI INOX/ABS 'SCAMPO' 19CM MOHA

UV1	UV2	IMBALLO
1	6	1/6/48 CD



7 6 1 1 2 6 4 2 5 5 0 3 2



ART	BARCODE	ST.	PREZZO
04 07 77	8004537407778		5,60

APRIOSTRICHE SOFT GRIP ACCIAIO INOSSIDABILE 18CM EVA

UV1	UV2	IMBALLO
1	6	1/12/144 CD



8 0 0 4 5 3 7 4 0 7 7 7 8



ART	BARCODE	ST.	PREZZO
04 06 97*	8004537406979	H	4,50

FORBICE PER CROSTACEI ACCIAIO INOSSIDABILE/PP 22CM EVA

UV1	UV2	IMBALLO
1	12	1/12/72 CD



8 0 0 4 5 3 7 4 0 6 9 7 9



ART	BARCODE	ST.	PREZZO
04 07 78	8004537407785		3,60

ROMPIGAMBERO ALLUMINIO 14 CM EVA

UV1	UV2	IMBALLO
1	12	1/12/72 BC



8 0 0 4 5 3 7 4 0 7 7 8 5



ART	BARCODE	ST.	PREZZO
04 06 98	8004537406986	A	2,50

ROMPIGAMBERO ALLUMINIO ROSSO EVA

UV1	UV2	IMBALLO
1	6	1/12/72 CD



8 0 0 4 5 3 7 4 0 6 9 8 6



ART	BARCODE	ST.	PREZZO
04 13 41	4004094660078		11,70

PINZA PER ARAGOSTE 'CRACKY' ALLUMINIO 14 CM WESTMARK

UV1	UV2	IMBALLO
1	5	1/5/80 CD



4 0 0 4 0 9 4 6 6 0 0 7 8



ART	BARCODE	ST.	PREZZO
04 13 42	4004094661075		15,10

PINZA PER ARAGOSTE CON PINZETTA AL/INOX 21 CM WESTMARK

UV1	UV2	IMBALLO
1	5	1/5/40 CD



4 0 0 4 0 9 4 6 6 1 0 7 5



ART	BARCODE	ST.	PREZZO
04 13 39	4004094661389		19,60

PINZA PER ARAGOSTE 'CAMMARUS' ACCIAIO INOSSIDABILE WESTMARK

UV1	UV2	IMBALLO
1	6	1/6/48 HB



4 0 0 4 0 9 4 6 6 1 3 8 9

Pasta Gnocchetti Pizza



ART	BARCODE	ST.	PREZZO
04 07 58	8008636033128		4,20

ROTELLA TAGLIAPASTA MANICO LEGNO GHIDINI CIPRIANO

UV1	UV2	IMBALLO
1	12	1/12/72 CD



8 0 0 8 6 3 6 0 3 3 1 2 8



ART	BARCODE	ST.	PREZZO
04 07 59	8004537407594		3,70

ROTELLA TAGLIAPASTA DOPPIO USO ACCIAIO INOSSIDABILE EVA

UV1	UV2	IMBALLO
1	12	1/12/144 CD



8 0 0 4 5 3 7 4 0 7 5 9 4



ART	BARCODE	ST.	PREZZO
04 04 79	8004537404791		3,15

TAGLIARAVIOLI ALLUMINIO MANICO LEGNO Ø6CM EVA

UV1	UV2	IMBALLO
1	12	1/12/144 CD



8 0 0 4 5 3 7 4 0 4 7 9 1



ART	BARCODE	ST.	PREZZO
04 04 80	8004537404807	A	2,95

TAGLIARAVIOLI ALLUMINIO MANICO LEGNO 6X6CM EVA

UV1	UV2	IMBALLO
1	12	1/12/144 CD



8 0 0 4 5 3 7 4 0 4 8 0 7



ART	BARCODE	ST.	PREZZO
04 04 76	8014405021494		11,90

RAVIOLATORE ALLU 24PZ QUADRATI+MATTARELLO 27X10CM

UV1	UV2	IMBALLO
1	4	1/40 HB



8 0 1 4 4 0 5 0 2 1 4 9 4



ART	BARCODE	ST.	PREZZO
04 04 77	8014405021517		12,80

RAVIOLATORE ALLU 24PZ ROTONDI+MATTARELLO 32X12CM

UV1	UV2	IMBALLO
1	4	1/36 HB



8 0 1 4 4 0 5 0 2 1 5 1 7



ART	BARCODE	ST.	PREZZO
04 04 78	8014405021524		14,75

RAVIOLATORE ALLU 12PZ ROTONDI+MATTARELLO 32X11CM

UV1	UV2	IMBALLO
1	4	1/36 HB



8 0 1 4 4 0 5 0 2 1 5 2 4



ART	BARCODE	ST.	PREZZO
04 05 74	4004094611377		6,65

GRATTUGIA PER GNOCCHI ABS "SPATZL" 32CM WESTMARK

UV1	UV2	IMBALLO
1	3	1/3/18 CD



4 0 0 4 0 9 4 6 1 1 3 7 7



ART	BARCODE	ST.	PREZZO
04 05 73	8004537405736		8,00

MACCHINA GNOCCHI ACCIAIO INOSSIDABILE+PLASTICA 32CM EVA

UV1	UV2	IMBALLO
1	12	1/12/48 CT



8 0 0 4 5 3 7 4 0 5 7 3 6



ART	BARCODE	ST.	PREZZO
04 05 75	8004537405750		15,50

MACCHINA GNOCCHI ACCIAIO INOSSIDABILE 18/8 32CM EVA

UV1	UV2	IMBALLO
1	12	1/6/48 CT



8 0 0 4 5 3 7 4 0 5 7 5 0



ART	BARCODE	ST.	PREZZO
04 05 77	4010411103005		99,50

MACCHINA PER SPATZLE PROFI ACCIAIO INOSSIDABILE 54CM WEIS

UV1	UV2	IMBALLO
1	2	1/2/24 HT



4 0 1 0 4 1 1 1 0 3 0 0 5



ART	BARCODE	ST.	PREZZO
04 05 79	8004537405798	A	8,90

GRATTUGIA ROTONDA GNOCCHI ACCIAIO INOSSIDABILE 27CM EVA

UV1	UV2	IMBALLO
1	6	1/6/24 SP



8 0 0 4 5 3 7 4 0 5 7 9 8



ART	BARCODE	ST.	PREZZO
04 20 59	8004537420593	H	8,90

**MANICO UNIVERSALE ACCIAIO
INOSSIDABILE/SILICONE EVA**

UV1	UV2	IMBALLO
1	6	1/12/96 CD



8 0 0 4 5 3 7 4 2 0 5 9 3



ART	BARCODE	ST.	PREZZO
04 07 54	8004537407549		5,75

**ROTELLA TAGLIAPIZZA JUMBO Ø10CM
EVA**

UV1	UV2	IMBALLO
1	12	1/12/72 CD



8 0 0 4 5 3 7 4 0 7 5 4 9



ART	BARCODE	ST.	PREZZO
05 31 17	7611264509791		9,25

**ROTELLA PIZZA 'TAGLIO' INOX/PP Ø 7CM
MOHA**

UV1	UV2	IMBALLO
1	6	1/6/72 CD



7 6 1 1 2 6 4 5 0 9 7 9 1



ART	BARCODE	ST.	PREZZO
01 36 70	8004537136708		11,90

**PIETRA CUOCIPIZZA
CERAMICA+SUPPORTO Ø33CM EVA**

UV1	UV2	IMBALLO
1	6	1/6 PB



8 0 0 4 5 3 7 1 3 6 7 0 8



ART	BARCODE	ST.	PREZZO
01 36 72	4004094324062	A	20,50

**PIETRA CUOCIPIZZA
CERAMICA+SUPPORTO Ø33CM
WESTMARK**

UV1	UV2	IMBALLO
1	3	1/3/6 PB



4 0 0 4 0 9 4 3 2 4 0 6 2



ART	BARCODE	ST.	PREZZO
01 36 73	4004094324260		23,40

**PIETRA CUOCIPIZZA
CERAMICA+SUPPORTO 38X30CM
WESTMARK**

UV1	UV2	IMBALLO
1	4	1/2/4 PB



4 0 0 4 0 9 4 3 2 4 2 6 0



ART	BARCODE	ST.	PREZZO
05 31 19	4004094324475		12,15

**PALA PER PIZZA IN LEGNO 45X29CM
WESTMARK**

UV1	UV2	IMBALLO
1	3	1/3/12 AL



4 0 0 4 0 9 4 3 2 4 4 7 5



ART	BARCODE	ST.	PREZZO
05 31 21	8004537531213	A	8,50

**SPATOLA PIZZA ACCIAIO INOSSIDABILE
MANICO PP 35CM EVA**

UV1	UV2	IMBALLO
1	6	1/6/36 HT



8 0 0 4 5 3 7 5 3 1 2 1 3



ART	BARCODE	ST.	PREZZO
04 74 74	8004537474749		7,75

**TEGLIA PIZZA TONDA ANTIADERENTE
Ø32CM EVA**

UV1	UV2	IMBALLO
1	10	1/10 CL



8 0 0 4 5 3 7 4 7 4 7 4 9



ART	BARCODE	ST.	PREZZO
04 76 08	4000823087147		27,20

**TEGLIA PIZZA 'FM PROFESSIONALE'
60X40CM ZENKER**

UV1	UV2	IMBALLO
1	5	1/5 AL



4 0 0 0 8 2 3 0 8 7 1 4 7



ART	BARCODE	ST.	PREZZO
04 14 51	8002942003639		8,80

**CASSETTA PORTAIMPASTI SOVRAPP.
'SERVICE' HDPE 10L 30X40X10CM**

UV1	UV2	IMBALLO
1	3	1/3 AL



8 0 0 2 9 4 2 0 0 3 6 3 9



ART	BARCODE	ST.	PREZZO
04 14 52	8002942018176		6,00

**COPERCHIO PER CASSETTA 'SERVICE'
HDPE 10L 30X40X10 CM**

UV1	UV2	IMBALLO
1	6	1/6 AL



8 0 0 2 9 4 2 0 1 8 1 7 6

Gadget Utensili Da Cucina



ART	BARCODE	ST.	PREZZO
04 52 07*	8004537452075	H	10,00

**FORCHETTONE 'OVALY' ACCIAIO
INOSSIDABILE 34 CM EVA**

UV1	UV2	IMBALLO
1	6	1/12/120 HT



8 0 0 4 5 3 7 4 5 2 0 7 5



ART	BARCODE	ST.	PREZZO
04 52 83*	8004537452839	H	14,80

**PALETTA PER PESCE 'OVALY' ACCIAIO
INOSSIDABILE EVA**

UV1	UV2	IMBALLO
1	6	1/6/72 HT



8 0 0 4 5 3 7 4 5 2 8 3 9



ART	BARCODE	ST.	PREZZO
04 01 50	8004537401509		11,50

**MESTOLO 'JUPITER' ACCIAIO
INOSSIDABILE 18/10 30CM Ø6CM**

UV1	UV2	IMBALLO
1	5	1/5/50 BK



8 0 0 4 5 3 7 4 0 1 5 0 9



ART	BARCODE	ST.	PREZZO
04 01 51	8004537401516		13,50

**MESTOLO 'JUPITER' ACCIAIO
INOSSIDABILE 18/10 32CM Ø9CM**

UV1	UV2	IMBALLO
1	5	1/5/50 BK



8 0 0 4 5 3 7 4 0 1 5 1 6



ART	BARCODE	ST.	PREZZO
04 01 52	8004537401523		13,50

**SCHIUMAROLA 'JUPITER' ACCIAIO
INOSSID. 18/10 35CM Ø11,5CM**

UV1	UV2	IMBALLO
1	5	1/5/50 BK



8 0 0 4 5 3 7 4 0 1 5 2 3



ART	BARCODE	ST.	PREZZO
04 01 53	8004537401530		10,50

**CUCCHIAIONE 'JUPITER' ACCIAIO
INOSSIDABILE 18/10 34CM**

UV1	UV2	IMBALLO
1	5	1/5/50 BK



8 0 0 4 5 3 7 4 0 1 5 3 0



ART	BARCODE	ST.	PREZZO
04 01 54	8004537401547		9,90

**FORCHETTONE 'JUPITER' ACCIAIO
INOSSIDABILE 18/10 35CM**

UV1	UV2	IMBALLO
1	5	1/5/50 BK



8 0 0 4 5 3 7 4 0 1 5 4 7



ART	BARCODE	ST.	PREZZO
04 01 55	8004537401554	A	13,50

**PALA FRITTI 'JUPITER' ACCIAIO INOSSID.
18/10 37,5CM Ø12CM**

UV1	UV2	IMBALLO
1	5	1/5/50 BK



8 0 0 4 5 3 7 4 0 1 5 5 4



ART	BARCODE	ST.	PREZZO
04 01 56	8004537401561		11,50

**SERVISPAGHETTI 'JUPITER' ACCIAIO
INOSSIDABILE 18/10 33CM**

UV1	UV2	IMBALLO
1	5	1/5/50 BK



8 0 0 4 5 3 7 4 0 1 5 6 1



ART	BARCODE	ST.	PREZZO
04 51 54	4004094183577	A	14,60

**PALETTA FORATA 'GLORY' ACCIAIO
INOSSIDABILE 34 CM WESTMARK**

UV1	UV2	IMBALLO
1	6	1/6/60 HT



4 0 0 4 0 9 4 1 8 3 5 7 7



ART	BARCODE	ST.	PREZZO
04 51 57	4004094184673	A	12,50

**FORCHETTONE 'GLORY' ACCIAIO
INOSSIDABILE 35 CM WESTMARK**

UV1	UV2	IMBALLO
1	6	1/6/72 HT



4 0 0 4 0 9 4 1 8 4 6 7 3



ART	BARCODE	ST.	PREZZO
04 51 58	4004094184871	A	16,55

**SCHIACCIAPATATE 'GLORY' ACCIAIO
INOSSIDABILE WESTMARK**

UV1	UV2	IMBALLO
1	6	1/6/36 HT



4 0 0 4 0 9 4 1 8 4 8 7 1



ART	BARCODE	ST.	PREZZO
04 51 70	4004094181474	A	7,30

FORCHETTA PATATE 'GLORY' ACCIAIO INOSSIDABILE WESTMARK

UV1	UV2	IMBALLO
1	6	1/6/54 HT



4 0 0 4 0 9 4 1 8 1 4 7 4



ART	BARCODE	ST.	PREZZO
04 51 67	4004094180477	A	8,10

PELAPATATE LAMA OSCILLANTE 'GLORY' ACCIAIO INOSSID WESTMARK

UV1	UV2	IMBALLO
1	6	1/6/96 HT



4 0 0 4 0 9 4 1 8 0 4 7 7



ART	BARCODE	ST.	PREZZO
04 51 76	4004094182877	A	9,30

ROTELLA PIZZA 'GLORY' ACCIAIO INOSSIDABILE Ø68MM WESTMARK

UV1	UV2	IMBALLO
1	6	1/6/24 HT



4 0 0 4 0 9 4 1 8 2 8 7 7



ART	BARCODE	ST.	PREZZO
04 51 52	4004094185670	A	16,30

MESTOLO 'GLORY' ACCIAIO INOSSIDABILE 9 CM WESTMARK

UV1	UV2	IMBALLO
1	6	1/6/36 HT



4 0 0 4 0 9 4 1 8 5 6 7 0



ART	BARCODE	ST.	PREZZO
04 51 55	4004094185175	A	16,30

SCHIUMAROLA 'GLORY' ACCIAIO INOSSIDABILE 11 CM WESTMARK

UV1	UV2	IMBALLO
1	6	1/6/72 HT



4 0 0 4 0 9 4 1 8 5 1 7 5



ART	BARCODE	ST.	PREZZO
04 51 56	4004094185571	A	16,30

SERVISPAGHETTI 'GLORY' ACCIAIO INOSSIDABILE 33 CM WESTMARK

UV1	UV2	IMBALLO
1	6	1/6/60 HT



4 0 0 4 0 9 4 1 8 5 5 7 1



ART	BARCODE	ST.	PREZZO
04 51 69	4004094180873	A	8,10

LEVACAPSULE 'GLORY' ACCIAIO INOSSIDABILE WESTMARK

UV1	UV2	IMBALLO
1	6	1/6/36 HT



4 0 0 4 0 9 4 1 8 0 8 7 3



ART	BARCODE	ST.	PREZZO
04 51 75	4004094182778	A	9,65

TAGLIAFORMAGGIO A FILO 'GLORY' ACCIAIO INOSSIDABIL WESTMARK

UV1	UV2	IMBALLO
1	6	1/6/18 HT



4 0 0 4 0 9 4 1 8 2 7 7 8



ART	BARCODE	ST.	PREZZO
04 51 79	4004094183478	A	8,10

SBUCCIATORE PER ARANCE 'GLORY' ACCIAIO INOSSIDABILE WESTMARK

UV1	UV2	IMBALLO
1	6	1/6/36 HT



4 0 0 4 0 9 4 1 8 3 4 7 8



ART	BARCODE	ST.	PREZZO
04 01 60	8004537401608	A	12,90

MESTOLO 'ARCO' ACCIAIO INOSSIDABILE 18/10 Ø 9 CM EVA

UV1	UV2	IMBALLO
1	6	1/6/48 CD



8 0 0 4 5 3 7 4 0 1 6 0 8



ART	BARCODE	ST.	PREZZO
04 01 61	8004537401615	A	8,50

MESTOLO SALSA 'ARCO' ACCIAIO INOSSIDABILE 18/10 Ø 7 CM EVA

UV1	UV2	IMBALLO
1	6	1/6/48 CD



8 0 0 4 5 3 7 4 0 1 6 1 5



ART	BARCODE	ST.	PREZZO
04 01 62	8004537401622	A	14,50

SCHIUMAROLA 'ARCO' ACCIAIO INOSSIDABILE 18/10 35 CM EVA

UV1	UV2	IMBALLO
1	6	1/6/48 CD



8 0 0 4 5 3 7 4 0 1 6 2 2



ART	BARCODE	ST.	PREZZO
04 01 63	8004537401639	A	11,50

CUCCHIAIONE 'ARCO' ACCIAIO INOSSIDABILE 18/10 31,5 CM EVA

UV1	UV2	IMBALLO
1	6	1/6/48 CD



8 0 0 4 5 3 7 4 0 1 6 3 9



ART	BARCODE	ST.	PREZZO
04 01 64	8004537401646	A	10,50

FORCHETTONE 'ARCO' ACCIAIO INOSSIDABILE 18/10 34 CM EVA

UV1	UV2	IMBALLO
1	6	1/6/48 CD



8 0 0 4 5 3 7 4 0 1 6 4 6



ART	BARCODE	ST.	PREZZO
04 01 65	8004537401653	A	12,50

PALETTA PER FRIGGERE 'ARCO' ACCIAIO INOX 18/10 34,5CM EVA

UV1	UV2	IMBALLO
1	6	1/6/48 CD



8 0 0 4 5 3 7 4 0 1 6 5 3



ART	BARCODE	ST.	PREZZO
04 01 66	8004537401660	A	11,00

SERVISPAGHETTI 'ARCO' ACCIAIO INOSSIDABILE 18/10 29,5CM EVA

UV1	UV2	IMBALLO
1	6	1/6/48 CD



8 0 0 4 5 3 7 4 0 1 6 6 0



ART	BARCODE	ST.	PREZZO
04 01 67	8004537401677	A	13,50

SCHIACCIAPATATE 'ARCO' ACCIAIO INOSSIDABILE 18/10 30 CM EVA

UV1	UV2	IMBALLO
1	6	1/6/48 CD



8 0 0 4 5 3 7 4 0 1 6 7 7



ART	BARCODE	ST.	PREZZO
04 01 70	8004537401707	A	9,50

MESTOLO 'MONO' ACCIAIO INOSSIDABILE 18/10 Ø 8,5 CM EVA

UV1	UV2	IMBALLO
1	12	1/12/72 HT



8 0 0 4 5 3 7 4 0 1 7 0 7



ART	BARCODE	ST.	PREZZO
04 01 71	8004537401714	A	7,90

MESTOLO SALSA 'MONO' ACCIAIO INOSSIDABILE 18/10 Ø 7 CM EVA

UV1	UV2	IMBALLO
1	12	1/12/72 HT



8 0 0 4 5 3 7 4 0 1 7 1 4



ART	BARCODE	ST.	PREZZO
04 01 72	8004537401721	A	9,50

SCHIUMAROLA 'MONO' ACCIAIO INOSSIDABILE 18/10 34,5 CM EVA

UV1	UV2	IMBALLO
1	12	1/12/72 HT



8 0 0 4 5 3 7 4 0 1 7 2 1



ART	BARCODE	ST.	PREZZO
04 01 73	8004537401738	A	7,90

CUCCHIAIONE 'MONO' ACCIAIO INOSSIDABILE 18/10 33 CM EVA

UV1	UV2	IMBALLO
1	12	1/12/72 HT



8 0 0 4 5 3 7 4 0 1 7 3 8



ART	BARCODE	ST.	PREZZO
04 01 76	8004537401769	A	8,90

SERVISPAGHETTI 'MONO' ACCIAIO INOSSIDABILE 18/10 30,5CM EVA

UV1	UV2	IMBALLO
1	12	1/12/72 HT



8 0 0 4 5 3 7 4 0 1 7 6 9



ART	BARCODE	ST.	PREZZO
04 01 75	8004537401752	A	7,90

PALETTA PER FRIGGERE 'MONO' ACCIAIO INOX 18/10 34,5CM EVA

UV1	UV2	IMBALLO
1	12	1/12/72 HT



8 0 0 4 5 3 7 4 0 1 7 5 2



ART	BARCODE	ST.	PREZZO
04 01 77	8004537401776	A	9,80

SCHIACCIAPATATE 'MONO' ACCIAIO INOSSIDABILE 18/10 23 CM EVA

UV1	UV2	IMBALLO
1	12	1/12/72 HT



8 0 0 4 5 3 7 4 0 1 7 7 6



ART	BARCODE	ST.	PREZZO
04 01 74	8004537401745	A	6,50

FORCHETTONE 'MONO' ACCIAIO INOSSIDABILE 18/10 32,5 CM EVA

UV1	UV2	IMBALLO
1	12	1/12/72 HT



8 0 0 4 5 3 7 4 0 1 7 4 5



ART	BARCODE	ST.	PREZZO
04 05 25	8004537405255		5,60

SCHIUMAROLA FILO ACCIAIO INOSSIDABILE Ø14CM EVA

UV1	UV2	IMBALLO
1	12	1/12/72 HT



8 0 0 4 5 3 7 4 0 5 2 5 5



ART	BARCODE	ST.	PREZZO
04 05 26	8004537405262		6,10

SCHIUMAROLA FILO ACCIAIO INOSSIDABILE Ø16CM EVA

UV1	UV2	IMBALLO
1	12	1/12/72 HT



8 0 0 4 5 3 7 4 0 5 2 6 2



ART	BARCODE	ST.	PREZZO
04 05 27	8004537405279		6,60

SCHIUMAROLA FILO ACCIAIO INOSSIDABILE Ø18CM EVA

UV1	UV2	IMBALLO
1	12	1/12/72 HT



8 0 0 4 5 3 7 4 0 5 2 7 9



ART	BARCODE	ST.	PREZZO
04 05 23	8004537405231		9,75

SCHIUMAROLA RETE ACCIAIO INOSSIDABILE 14 CM

UV1	UV2	IMBALLO
1	10	1/5/20 BK



8 0 0 4 5 3 7 4 0 5 2 3 1



ART	BARCODE	ST.	PREZZO
04 55 30	8004537455304		5,90

MESTOLO SALSA ACCIAIO INOSSIDABILE "DISEGNA" 6 CM EVA

UV1	UV2	IMBALLO
1	12	1/12/48 CD



8 0 0 4 5 3 7 4 5 5 3 0 4



ART	BARCODE	ST.	PREZZO
04 55 31	8004537455311		6,40

MESTOLO ACCIAIO INOSSIDABILE "DISEGNA" 9X33 CM EVA

UV1	UV2	IMBALLO
1	12	1/12/48 CD



8 0 0 4 5 3 7 4 5 5 3 1 1



ART	BARCODE	ST.	PREZZO
04 55 32	8004537455328		6,90

SCHIUMAROLA ACCIAIO INOSSIDABILE "DISEGNA" 11X37 CM EVA

UV1	UV2	IMBALLO
1	12	1/12/48 CD



8 0 0 4 5 3 7 4 5 5 3 2 8



ART	BARCODE	ST.	PREZZO
04 55 33	8004537455335		6,50

PALETTA PER FRIGGERE ACCIAIO INOSS. "DISEGNA" 9X37 CM EVA

UV1	UV2	IMBALLO
1	12	1/12/48 CD



8 0 0 4 5 3 7 4 5 5 3 3 5



ART	BARCODE	ST.	PREZZO
04 55 34	8004537455342		10,50

PALETTA PESCE E ASPARAGI ACCIAIO INOSS. "DISEGNA" 38X21CM EVA

UV1	UV2	IMBALLO
1	12	1/12/48 CD



8 0 0 4 5 3 7 4 5 5 3 4 2



ART	BARCODE	ST.	PREZZO
04 55 35	8004537455359		6,50

CUCCHIAIONE ACCIAIO INOSSIDABILE "DISEGNA" 36X7 CM EVA

UV1	UV2	IMBALLO
1	12	1/12/48 CD



8 0 0 4 5 3 7 4 5 5 3 5 9



ART	BARCODE	ST.	PREZZO
04 55 36	8004537455366		6,50

SERVI-SPAGHETTI ACCIAIO INOSSIDABILE "DISEGNA" 8X34 EVA

UV1	UV2	IMBALLO
1	12	1/12/48 CD



8 0 0 4 5 3 7 4 5 5 3 6 6



ART	BARCODE	ST.	PREZZO
04 55 37	8004537455373		6,50

SCHIACCIAPATATE ACCIAIO INOSSIDABILE "DISEGNA" 8X31 CM EVA

UV1	UV2	IMBALLO
1	12	1/12/48 CD



8 0 0 4 5 3 7 4 5 5 3 7 3



ART	BARCODE	ST.	PREZZO
04 55 38	8004537455380		3,90

FRUSTA ACCIAIO INOSSIDABILE "DISEGNA" 6.5X31 CM EVA

UV1	UV2	IMBALLO
1	12	1/12/48 CD



8 0 0 4 5 3 7 4 5 5 3 8 0



ART	BARCODE	ST.	PREZZO
04 55 39	8004537455397		3,50

GRATTUGIA ACCIAIO INOSSIDABILE "DISEGNA" 6X24 CM EVA

UV1	UV2	IMBALLO
1	12	1/12/48 CD



8 0 0 4 5 3 7 4 5 5 3 9 7



ART	BARCODE	ST.	PREZZO
04 55 40	8004537455403		6,90

APRISCATOLE ACCIAIO INOSSIDABILE "DISEGNA" 5X20 CM EVA

UV1	UV2	IMBALLO
1	12	1/12/48 CD



8 0 0 4 5 3 7 4 5 5 4 0 3



ART	BARCODE	ST.	PREZZO
04 55 41	8004537455410		6,90

SPREMIAGLIO ACCIAIO INOSSIDABILE "DISEGNA" 3X18CM EVA

UV1	UV2	IMBALLO
1	12	1/12/48 CD



8 0 0 4 5 3 7 4 5 5 4 1 0



ART	BARCODE	ST.	PREZZO
04 55 42	8004537455427		4,50

ROTELLA TAGLIAPIZZA ACCIAIO INOSS. "DISEGNA" 7,5X20 CM EVA

UV1	UV2	IMBALLO
1	12	1/12/48 CD



8 0 0 4 5 3 7 4 5 5 4 2 7



ART	BARCODE	ST.	PREZZO
04 55 43	8004537455434		2,90

SBUCCIATORE ACCIAIO INOSSIDABILE "DISEGNA" 19CM EVA

UV1	UV2	IMBALLO
1	12	1/12/48 CD



8 0 0 4 5 3 7 4 5 5 4 3 4



ART	BARCODE	ST.	PREZZO
04 55 44	8004537455441		3,50

SCAVINO 3CM ACCIAIO INOSSIDABILE "DISEGNA" 19CM EVA

UV1	UV2	IMBALLO
1	12	1/12/48 CD



8 0 0 4 5 3 7 4 5 5 4 4 1



ART	BARCODE	ST.	PREZZO
04 55 45	8004537455458		3,50

LEVATORSOLO ACCIAIO INOSSIDABILE "DISEGNA" 2X20CM EVA

UV1	UV2	IMBALLO
1	12	1/12/48 CD



8 0 0 4 5 3 7 4 5 5 4 5 8



ART	BARCODE	ST.	PREZZO
04 55 01*	8004537455014	H	3,70

SCAVINO "LOGIC" ACCIAIO INOSSIDABILE / PP Ø 10 MM EVA

UV1	UV2	IMBALLO
1	12	1/12/144 CD



8 0 0 4 5 3 7 4 5 5 0 1 4



ART	BARCODE	ST.	PREZZO
04 55 02*	8004537455021	H	3,70

SCAVINO "LOGIC" ACCIAIO INOSSIDABILE / PP Ø 15 MM EVA

UV1	UV2	IMBALLO
1	12	1/12/144 CD



8 0 0 4 5 3 7 4 5 5 0 2 1



ART	BARCODE	ST.	PREZZO
04 55 03*	8004537455038	H	3,70

SCAVINO "LOGIC" ACCIAIO INOSSIDABILE / PP Ø 18 MM EVA

UV1	UV2	IMBALLO
1	12	1/12/144 CD



8 0 0 4 5 3 7 4 5 5 0 3 8



ART	BARCODE	ST.	PREZZO
04 55 04	8004537455045	H	3,80

SCAVINO "LOGIC" ACCIAIO
INOSSIDABILE / PP Ø 22 MM EVA

UV1	UV2	IMBALLO
1	12	1/12/144 CD



8 0 0 4 5 3 7 4 5 5 0 4 5



ART	BARCODE	ST.	PREZZO
04 55 05	8004537455052	H	3,80

SCAVINO "LOGIC" ACCIAIO
INOSSIDABILE / PP Ø 25 MM EVA

UV1	UV2	IMBALLO
1	12	1/12/144 CD



8 0 0 4 5 3 7 4 5 5 0 5 2



ART	BARCODE	ST.	PREZZO
04 55 06	8004537455069	H	4,00

SCAVINO "LOGIC" ACCIAIO
INOSSIDABILE / PP Ø 30 MM EVA

UV1	UV2	IMBALLO
1	12	1/12/144 CD



8 0 0 4 5 3 7 4 5 5 0 6 9



ART	BARCODE	ST.	PREZZO
04 55 07	8004537455076	H	3,80

SCAVINO PER POMODORI "LOGIC"
ACCIAIO INOSSIDABILE / PP EVA

UV1	UV2	IMBALLO
1	12	1/12/144 CD



8 0 0 4 5 3 7 4 5 5 0 7 6



ART	BARCODE	ST.	PREZZO
04 55 08	8004537455083	H	3,70

SCAVINO OVALE "LOGIC" ACCIAIO
INOSSIDABILE / PP EVA

UV1	UV2	IMBALLO
1	12	1/12/144 CD



8 0 0 4 5 3 7 4 5 5 0 8 3



ART	BARCODE	ST.	PREZZO
04 55 09	8004537455090	H	3,80

SCAVINO OVALE FESTONATO "LOGIC"
ACCIAIO INOSSIDABILE/PP EVA

UV1	UV2	IMBALLO
1	12	1/12/144 CD



8 0 0 4 5 3 7 4 5 5 0 9 0



ART	BARCODE	ST.	PREZZO
04 55 10	8004537455106	H	2,75

DECORATORE/CESELLATORE "LOGIC"
ACCIAIO INOSSIDABILE / PP EVA

UV1	UV2	IMBALLO
1	12	1/12/144 CD



8 0 0 4 5 3 7 4 5 5 1 0 6



ART	BARCODE	ST.	PREZZO
04 55 11	8004537455113	H	3,10

RIGA-LIMONI / ZESTER "LOGIC" ACCIAIO
INOSSIDABILE / PP EVA

UV1	UV2	IMBALLO
1	12	1/12/144 CD



8 0 0 4 5 3 7 4 5 5 1 1 3



ART	BARCODE	ST.	PREZZO
04 55 12	8004537455120	H	3,20

RIGA-LIMONI / ZESTER+FORO "LOGIC"
ACCIAIO INOSSIDABILE/PP EVA

UV1	UV2	IMBALLO
1	12	1/12/144 CD



8 0 0 4 5 3 7 4 5 5 1 2 0



ART	BARCODE	ST.	PREZZO
04 55 13	8004537455137	H	3,35

COLTELLO DECORATORE LAMA A "V"
"LOGIC" ACCIAIO INOSS/PP EVA

UV1	UV2	IMBALLO
1	12	1/12/144 CD



8 0 0 4 5 3 7 4 5 5 1 3 7



ART	BARCODE	ST.	PREZZO
04 55 14	8004537455144	H	3,00

LEVATORSOLI Ø 16MM "LOGIC" ACCIAIO
INOSSIDABILE / PP EVA

UV1	UV2	IMBALLO
1	12	1/12/144 CD



8 0 0 4 5 3 7 4 5 5 1 4 4



ART	BARCODE	ST.	PREZZO
04 55 16	8004537455168	H	3,35

SBUCCIA-ARANZE "LOGIC" ACCIAIO
INOSSIDABILE / PP EVA

UV1	UV2	IMBALLO
1	12	1/12/144 CD



8 0 0 4 5 3 7 4 5 5 1 6 8



ART	BARCODE	ST.	PREZZO
04 55 17*	8004537455175	H	4,75

COLTELLO PER POMPELMI "LOGIC"
ACCIAIO INOSSIDABILE / PP EVA

UV1	UV2	IMBALLO
1	12	1/12/144 CD



8 0 0 4 5 3 7 4 5 5 1 7 5



ART	BARCODE	ST.	PREZZO
04 55 18*	8004537455182	H	2,80

PELATAPATE "LOGIC" ACCIAIO
INOSSIDABILE / PP EVA

UV1	UV2	IMBALLO
1	12	1/12/144 CD



8 0 0 4 5 3 7 4 5 5 1 8 2



ART	BARCODE	ST.	PREZZO
04 55 22*	8004537455229	H	3,60

FORCHETTA PER PATATE "LOGIC"
ACCIAIO INOSSIDABILE / PP EVA

UV1	UV2	IMBALLO
1	12	1/12/144 CD



8 0 0 4 5 3 7 4 5 5 2 2 9



ART	BARCODE	ST.	PREZZO
04 55 19*	8004537455199	H	3,35

VUOTAZUCCHINE "LOGIC" ACCIAIO
INOSSIDABILE / PP EVA

UV1	UV2	IMBALLO
1	12	1/12/144 CD



8 0 0 4 5 3 7 4 5 5 1 9 9



ART	BARCODE	ST.	PREZZO
04 55 20*	8004537455205	H	4,20

ARRICCIABURRO "LOGIC" ACCIAIO
INOSSIDABILE / PP EVA

UV1	UV2	IMBALLO
1	12	1/12/144 CD



8 0 0 4 5 3 7 4 5 5 2 0 5



ART	BARCODE	ST.	PREZZO
04 51 30	4004094014116		5,70

PALETTA FORATA 'MASTER LINE'
ANGOLARE FLEXI 27.5 CM WESTMARK

UV1	UV2	IMBALLO
1	3	1/3/24 HT



4 0 0 4 0 9 4 0 1 4 1 1 6



ART	BARCODE	ST.	PREZZO
04 51 31	4004094133572		8,30

PALETTA FORATA 'MASTER LINE' DRITTA
FLEXI 29.5CM WESTMARK

UV1	UV2	IMBALLO
1	3	1/3/24 HT



4 0 0 4 0 9 4 1 3 3 5 7 2



ART	BARCODE	ST.	PREZZO
04 51 32	4004094014123		7,20

PALETTA 'MASTER LINE' ANGOLARE
CHIUSA FLEXI 31.5CM WESTMARK

UV1	UV2	IMBALLO
1	3	1/3/24 HT



4 0 0 4 0 9 4 0 1 4 1 2 3



ART	BARCODE	ST.	PREZZO
04 51 33	4004094133770		7,20

PALETTA 'MASTER LINE' ANGOLARE A
FORI 31.5CM WESTMARK

UV1	UV2	IMBALLO
1	3	1/3/24 HT



4 0 0 4 0 9 4 1 3 3 7 7 0



ART	BARCODE	ST.	PREZZO
04 51 34	4004094133879		7,70

PALETTA 'MASTER LINE' ANGOLARE
CHIUSA FLEXI 36.5CM WESTMARK

UV1	UV2	IMBALLO
1	3	1/3/24 HT



4 0 0 4 0 9 4 1 3 3 8 7 9



ART	BARCODE	ST.	PREZZO
04 51 35	4004094133978		7,70

PALETTA 'MASTER LINE' ANGOLARE A
FORI 36.5CM WESTMARK

UV1	UV2	IMBALLO
1	3	1/3/24 HT



4 0 0 4 0 9 4 1 3 3 9 7 8



ART	BARCODE	ST.	PREZZO
04 51 36	4004094311871		4,50

SPATOLA PASTICCERIA 'MASTER LINE'
DRITTA FLEXI 22.5CM WESTMA

UV1	UV2	IMBALLO
1	3	1/3/24 CD



4 0 0 4 0 9 4 3 1 1 8 7 1



ART	BARCODE	ST.	PREZZO
04 51 37	4004094311970		5,30

SPATOLA PASTICCERIA 'MASTER LINE'
DRITTA FLEXI 26CM WESTMARK

UV1	UV2	IMBALLO
1	3	1/3/24 CD



4 0 0 4 0 9 4 3 1 1 9 7 0



ART	BARCODE	ST.	PREZZO
04 51 43	4004094312670		3,95

SPATOLA PASTICCERIA 'MASTER LINE'
ANGOLARE FLEXI 29,5CM WEST

UV1	UV2	IMBALLO
1	3	1/3/36 CD



4 0 0 4 0 9 4 3 1 2 6 7 0



ART	BARCODE	ST.	PREZZO
04 51 38	4004094312175		6,00

SPATOLA PASTICCERIA 'MASTER LINE'
DRITTA FLEXI 30CM WESTMARK

UV1	UV2	IMBALLO
1	3	1/3/24 CD



4 0 0 4 0 9 4 3 1 2 1 7 5



ART	BARCODE	ST.	PREZZO
04 51 42	4004094312571		3,20

SPATOLA PASTICCERIA 'MASTER LINE'
ANGOLARE FLEXI 25CM WESTMA

UV1	UV2	IMBALLO
1	3	1/3/24 CD



4 0 0 4 0 9 4 3 1 2 5 7 1



ART	BARCODE	ST.	PREZZO
04 51 46	4004094135774		5,40

COLTELLO PER BURRO 'MASTER LINE'
18.5CM WESTMARK

UV1	UV2	IMBALLO
1	3	1/3/24 CD



4 0 0 4 0 9 4 1 3 5 7 7 4



ART	BARCODE	ST.	PREZZO
04 20 94	8004537420944		2,60

PALA CREPES 'HIGHGRADE' 33 CM EVA

UV1	UV2	IMBALLO
1	6	1/6/150 CD



8 0 0 4 5 3 7 4 2 0 9 4 4



ART	BARCODE	ST.	PREZZO
04 20 93	8004537420937		2,60

SERVISPAGHETTI 'HIGHGRADE' 33 CM
EVA

UV1	UV2	IMBALLO
1	6	1/6/150 CD



8 0 0 4 5 3 7 4 2 0 9 3 7



ART	BARCODE	ST.	PREZZO
04 20 86	8004537420869		2,50

CUCCHIAIONE 'HIGHGRADE' 30CM EVA

UV1	UV2	IMBALLO
1	6	1/6/150 CD



8 0 0 4 5 3 7 4 2 0 8 6 9



ART	BARCODE	ST.	PREZZO
04 20 88	8004537420883		3,10

MESTOLO HIGHGRADE 9X33CM EVA

UV1	UV2	IMBALLO
1	6	1/6/72 CD



8 0 0 4 5 3 7 4 2 0 8 8 3



ART	BARCODE	ST.	PREZZO
04 20 90	8004537420906		2,95

SCHIUMAROLA HIGHGRADE 33CM EVA

UV1	UV2	IMBALLO
1	6	1/6/150 CD



8 0 0 4 5 3 7 4 2 0 9 0 6



ART	BARCODE	ST.	PREZZO
04 20 89	8004537420890		2,60

PALETTA FORATA HIGHGRADE 34CM
EVA

UV1	UV2	IMBALLO
1	6	1/6/150 CD



8 0 0 4 5 3 7 4 2 0 8 9 0



ART	BARCODE	ST.	PREZZO
04 20 81	8004537420814		2,50

PINZA CHEF 'HIGHGRADE' 27CM EVA

UV1	UV2	IMBALLO
1	6	1/6/150 CD



8 0 0 4 5 3 7 4 2 0 8 1 4



ART	BARCODE	ST.	PREZZO
04 20 82	8004537420821	A	3,10

PINZA ARROSTO 'HIGHGRADE' 27CM EVA

UV1	UV2	IMBALLO
1	6	1/6/150 CD



8 0 0 4 5 3 7 4 2 0 8 2 1



ART	BARCODE	ST.	PREZZO
04 20 83*	8004537420838	A	3,70

PINZA PESCE+ASPARAGI 'HIGHGRADE' 27X15CM EVA

UV1	UV2	IMBALLO
1	6	1/6/150 CD



8 0 0 4 5 3 7 4 2 0 8 3 8



ART	BARCODE	ST.	PREZZO
04 20 84	8004537420845		3,40

PINZA INSALATA 'HIGHGRADE' 27CM EVA

UV1	UV2	IMBALLO
1	6	1/6/150 CD



8 0 0 4 5 3 7 4 2 0 8 4 5



ART	BARCODE	ST.	PREZZO
04 20 85	8004537420852		3,40

MOLLA PER SPAGHETTI 'HIGHGRADE' 27CM EVA

UV1	UV2	IMBALLO
1	6	1/6/90 CD



8 0 0 4 5 3 7 4 2 0 8 5 2



ART	BARCODE	ST.	PREZZO
04 20 87	8004537420876		2,50

PALETTA LASAGNE 'HIGHGRADE' 26CM EVA

UV1	UV2	IMBALLO
1	6	1/6/150 CD



8 0 0 4 5 3 7 4 2 0 8 7 6



ART	BARCODE	ST.	PREZZO
04 20 91	8004537420913		2,70

PALETTA FORATA LASAGNE 'HIGHGRADE' 29 CM EVA

UV1	UV2	IMBALLO
1	6	1/6/150 CD



8 0 0 4 5 3 7 4 2 0 9 1 3



ART	BARCODE	ST.	PREZZO
04 20 92	8004537420920		2,60

PALETTA MULTIUSO 'HIGHGRADE' 34CM EVA

UV1	UV2	IMBALLO
1	6	1/6/150 CD



8 0 0 4 5 3 7 4 2 0 9 2 0



ART	BARCODE	ST.	PREZZO
04 53 86	4004094283277		4,00

ROTELLA TAGLIAPASTA 'GENTLE' PP/LAMA IN INOX WESTMARK

UV1	UV2	IMBALLO
1	6	1/6/60 CD



4 0 0 4 0 9 4 2 8 3 2 7 7



ART	BARCODE	ST.	PREZZO
04 53 85	4004094283079		5,50

RIGALIMONI 'GENTLE' PP/LAMA IN ACCIAIO INOSSIDABILE WESTMARK

UV1	UV2	IMBALLO
1	6	1/6/72 CD



4 0 0 4 0 9 4 2 8 3 0 7 9



ART	BARCODE	ST.	PREZZO
04 53 84	4004094282874		6,50

ROTELLA PIZZA 'GENTILE' PP/LAMA IN ACCIAIO INOSSID. WESTMARK

UV1	UV2	IMBALLO
1	6	1/6/72 CD



4 0 0 4 0 9 4 2 8 2 8 7 4



ART	BARCODE	ST.	PREZZO
04 53 83	4004094281471		3,70

FORCHETTA PATATE 'GENTILE' PP/LAMA IN ACCIAIO INOX WESTMARK

UV1	UV2	IMBALLO
1	6	1/6/72 CD



4 0 0 4 0 9 4 2 8 1 4 7 1



ART	BARCODE	ST.	PREZZO
04 53 82	4004094281174		4,85

SBUCCIATORE 'GENTILE' PP/LAMA IN CERAMICA WESTMARK

UV1	UV2	IMBALLO
1	6	1/6/90 CD



4 0 0 4 0 9 4 2 8 1 1 7 4



ART	BARCODE	ST.	PREZZO
04 53 81	4004094281075	H	2,25

FORA LATTINE 'GENTLE' PP/ACCIAIO WESTMARK

UV1	UV2	IMBALLO
1	6	1/6/72 CD



4 0 0 4 0 9 4 2 8 1 0 7 5



ART	BARCODE	ST.	PREZZO
04 53 79	4004094280672		3,70

PELAPATATE 'GENTLE' PP/ACCIAIO INOSSIDABILE WESTMARK

UV1	UV2	IMBALLO
1	6	1/6/48 CD



4 0 0 4 0 9 4 2 8 0 6 7 2



ART	BARCODE	ST.	PREZZO
04 53 75	4004094281877		3,90

LEVATORSOLO 'GENTLE' PP/ACCIAIO INOSSIDABILE WESTMARK

UV1	UV2	IMBALLO
1	6	1/6/60 CD



4 0 0 4 0 9 4 2 8 1 8 7 7



ART	BARCODE	ST.	PREZZO
04 53 73	4004094280474		4,25

SBUCCIATORE 'GENTLE' PP/ACCIAIO WESTMARK

UV1	UV2	IMBALLO
1	6	1/6/96 CD



4 0 0 4 0 9 4 2 8 0 4 7 4



ART	BARCODE	ST.	PREZZO
04 53 72	4004094280375	A	4,70

SBUCCIATORE PER MANCINI 'GENTLE' PP/ACCIAIO WESTMARK

UV1	UV2	IMBALLO
1	6	1/6/96 CD



4 0 0 4 0 9 4 2 8 0 3 7 5



ART	BARCODE	ST.	PREZZO
04 53 71	4004094280276		3,50

SBUCCIATORE 'GENTLE' PP/ACCIAIO WESTMARK

UV1	UV2	IMBALLO
1	6	1/6/90 CD



4 0 0 4 0 9 4 2 8 0 2 7 6



ART	BARCODE	ST.	PREZZO
04 53 68	4004094286872		4,10

FRUSTA 'GENTLE' PA 28 CM WESTMARK

UV1	UV2	IMBALLO
1	6	1/6/30 CD



4 0 0 4 0 9 4 2 8 6 8 7 2



ART	BARCODE	ST.	PREZZO
04 53 67	4004094286674		3,90

SPATOLA CREPES 'GENTLE' PA 33 CM WESTMARK

UV1	UV2	IMBALLO
1	6	1/6/60 CD



4 0 0 4 0 9 4 2 8 6 6 7 4



ART	BARCODE	ST.	PREZZO
04 53 66	4004094286575		3,90

CUCCHIAIONE WOK 'GENTLE' PA 32 CM WESTMARK

UV1	UV2	IMBALLO
1	6	1/6/60 CD



4 0 0 4 0 9 4 2 8 6 5 7 5



ART	BARCODE	ST.	PREZZO
04 53 65	4004094286070		3,90

SERVISPAGHETTI 'GENTLE' PA 31 CM WESTMARK

UV1	UV2	IMBALLO
1	6	1/6/60 CD



4 0 0 4 0 9 4 2 8 6 0 7 0



ART	BARCODE	ST.	PREZZO
04 53 64	4004094283574		4,15

PALETTA FORATA 'GENTLE' PA 30 CM WESTMARK

UV1	UV2	IMBALLO
1	6	1/6/72 CD



4 0 0 4 0 9 4 2 8 3 5 7 4



ART	BARCODE	ST.	PREZZO
04 53 63	4004094285073		3,90

SCHIUMAROLA 'GENTLE' PA 32 CM WESTMARK

UV1	UV2	IMBALLO
1	6	1/6/60 CD



4 0 0 4 0 9 4 2 8 5 0 7 3



ART	BARCODE	ST.	PREZZO
04 53 62	4004094285677		3,90

MESTOLO MINESTRA 'GENTLE' PA 32 CM WESTMARK

UV1	UV2	IMBALLO
1	6	1/6/36 CD



4 0 0 4 0 9 4 2 8 5 6 7 7



ART	BARCODE	ST.	PREZZO
04 53 61	4004094285479		3,90

MESTOLO SALSA 'GENTLE' PA 29 CM WESTMARK

UV1	UV2	IMBALLO
1	6	1/6/60 CD



4 0 0 4 0 9 4 2 8 5 4 7 9



ART	BARCODE	ST.	PREZZO
04 53 88	4004094288470		3,70

CUCCHIAIO DA CUCINA 'GENTLE' PA 30 CM WESTMARK

UV1	UV2	IMBALLO
1	6	1/6/60 CD



4 0 0 4 0 9 4 2 8 8 4 7 0



ART	BARCODE	ST.	PREZZO
04 53 89	4004094286377		4,10

SCHIACCIA PATATE 'GENTLE' PA 27,5 CM WESTMARK

UV1	UV2	IMBALLO
1	4	1/4/32 CD



4 0 0 4 0 9 4 2 8 6 3 7 7



ART	BARCODE	ST.	PREZZO
04 53 06	7611264508077		6,50

SPATOLA PASTICCERIA 'CULINARIO' NYLON/SILICONE 4X27 CM MOHA

UV1	UV2	IMBALLO
1	6	1/6/48 HT



7 6 1 1 2 6 4 5 0 8 0 7 7



ART	BARCODE	ST.	PREZZO
04 53 05	7611264508039		7,50

SPATOLA PASTICCERIA 'CULINARIO' NYLON/SILICONE 5X27CM MOHA

UV1	UV2	IMBALLO
1	6	1/6/48 HT



7 6 1 1 2 6 4 5 0 8 0 3 9



ART	BARCODE	ST.	PREZZO
04 53 07	7611264508060		6,00

SPATOLINA 'CULINARIO' NYLON/SILICONE 3X18 CM MOHA

UV1	UV2	IMBALLO
1	6	1/6/48 HT



7 6 1 1 2 6 4 5 0 8 0 6 0



ART	BARCODE	ST.	PREZZO
04 53 08	7611264508046		9,00

PENNELLO PASTICCERIA 'CULINARIO' NYLON/SILICONE 27.5CM MOHA

UV1	UV2	IMBALLO
1	6	1/6/48 HT



7 6 1 1 2 6 4 5 0 8 0 4 6



ART	BARCODE	ST.	PREZZO
04 53 01	7611264508008		9,50

MESTOLO 'CULINARIO' NYLON+SILICONE 9X31 CM MOHA

UV1	UV2	IMBALLO
1	6	1/6/24 HT



7 6 1 1 2 6 4 5 0 8 0 0 8



ART	BARCODE	ST.	PREZZO
04 53 02	7611264508022		9,50

SCHIUMAROLA 'CULINARIO' NYLON+SILICONE 11X34 CM MOHA

UV1	UV2	IMBALLO
1	6	1/6/24 HT



7 6 1 1 2 6 4 5 0 8 0 2 2



ART	BARCODE	ST.	PREZZO
04 53 03	7611264507995		9,50

PALETTA FORATA 'CULINARIO' NYLON+SILICONE 9X34 CM MOHA

UV1	UV2	IMBALLO
1	6	1/6/24 HT



7 6 1 1 2 6 4 5 0 7 9 9 5



ART	BARCODE	ST.	PREZZO
04 53 04	7611264508015		9,50

CUCCHIAIONE 'CULINARIO' NYLON+SILICONE 6.5X34 CM MOHA

UV1	UV2	IMBALLO
1	6	1/6/24 HT



7 6 1 1 2 6 4 5 0 8 0 1 5



ART	BARCODE	ST.	PREZZO
04 13 04	4004094203572		5,10

PALETTA 'FLONAL' PA 28 CM WESTMARK

UV1	UV2	IMBALLO
1	5	1/10/100 CD



4 0 0 4 0 9 4 2 0 3 5 7 2



ART	BARCODE	ST.	PREZZO
04 18 76	8004537418767		5,50

PINZA 'CHEF' ACCIAIO INOSSIDABILE 18/10 32CM EVA

UV1	UV2	IMBALLO
1	5	1/100 CD



8 0 0 4 5 3 7 4 1 8 7 6 7



ART	BARCODE	ST.	PREZZO
04 20 78	4004094136979		3,60

PINZA DA CUCINA PA NERO 29CM WESTMARK

UV1	UV2	IMBALLO
1	6	1/6/48 CD



4 0 0 4 0 9 4 1 3 6 9 7 9



ART	BARCODE	ST.	PREZZO
04 20 79	4004094286971		4,75

PINZA SERVIRE/CUCINA PA NERO 33CM WESTMARK

UV1	UV2	IMBALLO
1	6	1/6/36 CD



4 0 0 4 0 9 4 2 8 6 9 7 1



ART	BARCODE	ST.	PREZZO
04 20 75	8004537420753	H	4,90

PINZA CUCINA LEGNO FAGGIO 28CM

UV1	UV2	IMBALLO
1	6	1/25 PH



8 0 0 4 5 3 7 4 2 0 7 5 3



ART	BARCODE	ST.	PREZZO
04 18 79	8004537418798		2,40

PINZA INSALATA PLASTICA 28 CM EVA

UV1	UV2	IMBALLO
1	12	1/12/144 CD



8 0 0 4 5 3 7 4 1 8 7 9 8



ART	BARCODE	ST.	PREZZO
04 20 56	8004537420562	H	2,50

PINZA INSALATA ACCIAIO INOSSIDABILE 19CM EVA

UV1	UV2	IMBALLO
1	12	1/12/72 CD



8 0 0 4 5 3 7 4 2 0 5 6 2



ART	BARCODE	ST.	PREZZO
04 20 57	8004537420579	H	2,95

PINZA PER SERVIRE ACCIAIO INOSSIDABILE 19CM EVA

UV1	UV2	IMBALLO
1	12	1/12/72 CD



8 0 0 4 5 3 7 4 2 0 5 7 9



ART	BARCODE	ST.	PREZZO
04 18 93	4004094627668		4,90

PINZA GHIACCIO "ARCTICA" ACCIAIO INOSSIDABILE 18 CM WESTMARK

UV1	UV2	IMBALLO
1	3	1/3/24 HB



4 0 0 4 0 9 4 6 2 7 6 6 8



ART	BARCODE	ST.	PREZZO
04 18 94	4004094626579		3,95

PINZA PER ZUCCHERO ACCIAIO INOSSIDABILE 12.5 CM WESTMARK

UV1	UV2	IMBALLO
1	3	1/3/60 CD



4 0 0 4 0 9 4 6 2 6 5 7 9



ART	BARCODE	ST.	PREZZO
04 02 50	7611264813904		5,05

PINZA ACCIAIO INOSSIDABILE 18/10+SILICONE 'MANI' 13CM MOHA

UV1	UV2	IMBALLO
1	12	1/12/144 CD



7 6 1 1 2 6 4 8 1 3 9 0 4



ART	BARCODE	ST.	PREZZO
04 03 51	4000270698019		0,90

CUCCHIAIO ROTONDO LEGNO DI FAGGIO FSC 25CM KESPER

UV1	UV2	IMBALLO
1	10	1/10/100 CD



4 0 0 0 2 7 0 6 9 8 0 1 9



ART	BARCODE	ST.	PREZZO
04 03 52	4000270698026		1,00

**CUCCHIAIO ROTONDO LEGNO DI FAGGIO
FSC 28CM KESPER**

UV1	UV2	IMBALLO
1	10	1/10/100 CD



4 0 0 0 2 7 0 6 9 8 0 2 6



ART	BARCODE	ST.	PREZZO
04 03 53	4000270698033		1,10

**CUCCHIAIO ROTONDO LEGNO DI FAGGIO
FSC 32CM KESPER**

UV1	UV2	IMBALLO
1	10	1/10/100 CD



4 0 0 0 2 7 0 6 9 8 0 3 3



ART	BARCODE	ST.	PREZZO
04 03 54	4000270698040		1,30

**CUCCHIAIO ROTONDO LEGNO DI FAGGIO
FSC 35CM KESPER**

UV1	UV2	IMBALLO
1	10	1/10/100 CD



4 0 0 0 2 7 0 6 9 8 0 4 0



ART	BARCODE	ST.	PREZZO
04 03 55	4000270698057		1,60

**CUCCHIAIO ROTONDO LEGNO DI FAGGIO
FSC 40CM KESPER**

UV1	UV2	IMBALLO
1	10	1/10/100 CD



4 0 0 0 2 7 0 6 9 8 0 5 7



ART	BARCODE	ST.	PREZZO
04 03 56	4000270698064		2,75

**CUCCHIAIO ROTONDO LEGNO DI FAGGIO
FSC 45CM KESPER**

UV1	UV2	IMBALLO
1	10	1/10/100 CD



4 0 0 0 2 7 0 6 9 8 0 6 4



ART	BARCODE	ST.	PREZZO
04 03 57	4000270698071		3,95

**CUCCHIAIO ROTONDO LEGNO DI FAGGIO
FSC 50CM KESPER**

UV1	UV2	IMBALLO
1	10	1/10/100 CD



4 0 0 0 2 7 0 6 9 8 0 7 1



ART	BARCODE	ST.	PREZZO
04 03 58	4000270698088		6,50

**CUCCHIAIO ROTONDO LEGNO DI FAGGIO
FSC 60CM KESPER**

UV1	UV2	IMBALLO
1	10	1/5/50 CD



4 0 0 0 2 7 0 6 9 8 0 8 8



ART	BARCODE	ST.	PREZZO
04 03 59	4000270698095	A	8,95

**CUCCHIAIO ROTONDO LEGNO DI FAGGIO
FSC 70CM KESPER**

UV1	UV2	IMBALLO
1	5	1/5/50 CD



4 0 0 0 2 7 0 6 9 8 0 9 5



ART	BARCODE	ST.	PREZZO
04 03 60	4000270698309		0,95

**CUCCHIAIO OVALE LEGNO DI FAGGIO
FSC 25CM KESPER**

UV1	UV2	IMBALLO
1	10	1/10/100 CD



4 0 0 0 2 7 0 6 9 8 3 0 9



ART	BARCODE	ST.	PREZZO
04 03 61	4000270698316		1,10

**CUCCHIAIO OVALE LEGNO DI FAGGIO
FSC 30CM KESPER**

UV1	UV2	IMBALLO
1	10	1/10/100 CD



4 0 0 0 2 7 0 6 9 8 3 1 6



ART	BARCODE	ST.	PREZZO
04 03 62	4000270698323		1,25

**CUCCHIAIO OVALE LEGNO DI FAGGIO
FSC 35CM KESPER**

UV1	UV2	IMBALLO
1	10	1/10/100 CD



4 0 0 0 2 7 0 6 9 8 3 2 3



ART	BARCODE	ST.	PREZZO
04 03 63	4000270698354		1,60

**CUCCHIAIO OVALE LEGNO DI FAGGIO
FSC 40CM KESPER**

UV1	UV2	IMBALLO
1	10	1/10/100 CD



4 0 0 0 2 7 0 6 9 8 3 5 4



ART	BARCODE	ST.	PREZZO
04 03 69	8004537403695		2,95

3 CUCCHIAI IN LEGNO DI FAGGIO FSC OVALE 25/30/35CM EVA

UV1	UV2	IMBALLO
1	12	1/12 CD



8 0 0 4 5 3 7 4 0 3 6 9 5



ART	BARCODE	ST.	PREZZO
04 03 71	8004537403718		3,50

4 CUCCHIAI LEGNO DI FAGGIO FSC ASSORTITI 25/30/35CM EVA

UV1	UV2	IMBALLO
1	12	1/12 CD



8 0 0 4 5 3 7 4 0 3 7 1 8



ART	BARCODE	ST.	PREZZO
04 03 74	4000270694400		0,95

PALETTA LEGNO DI FAGGIO FSC 30 CM KESPER

UV1	UV2	IMBALLO
1	10	1/10/200 CD



4 0 0 0 2 7 0 6 9 4 4 0 0



ART	BARCODE	ST.	PREZZO
04 50 71	4009085003506	A	2,00

CUCCHIAIO SERVI-INSALATA SAN TRASPARENTE 23,5 CM WACA

UV1	UV2	IMBALLO
1	10	1/1 PG



4 0 0 9 0 8 5 0 0 3 5 0 6



ART	BARCODE	ST.	PREZZO
04 50 74	4009085003414	A	2,00

CUCCHIAIO FORATO SERVI-INSALATA SAN TRASPARENTE 23,5 CM WACA

UV1	UV2	IMBALLO
1	10	1/1 PG



4 0 0 9 0 8 5 0 0 3 4 1 4



ART	BARCODE	ST.	PREZZO
04 50 77	4009085034241	A	3,10

CUCCHIAIO PER DRESSING SAN TRASPARENTE 34 CM WACA

UV1	UV2	IMBALLO
1	10	1/5 CD



4 0 0 9 0 8 5 0 3 4 2 4 1



ART	BARCODE	ST.	PREZZO
04 50 89	4009085009218	A	2,20

PALETTA PER DOLCI SAN BIANCO 23.5CM WACA

UV1	UV2	IMBALLO
1	10	1/5 BK



4 0 0 9 0 8 5 0 0 9 2 1 8



ART	BARCODE	ST.	PREZZO
04 50 94	4009085099202	A	4,95

PINZA A FORBICE SAN BIANCO 27.5CM WACA

UV1	UV2	IMBALLO
1	10	1/1 PG



4 0 0 9 0 8 5 0 9 9 2 0 2



ART	BARCODE	ST.	PREZZO
04 50 95	4009085257084	A	4,95

PINZA A FORBICE SAN NERO 27.5CM WACA

UV1	UV2	IMBALLO
1	10	1/5 CD



4 0 0 9 0 8 5 2 5 7 0 8 4



ART	BARCODE	ST.	PREZZO
04 18 86	8004537418866		10,25

APPOGGIAMESTOLI ACCIAIO INOSSIDABILE 18/8 EVA

UV1	UV2	IMBALLO
1	12	1/12/96 CD



8 0 0 4 5 3 7 4 1 8 8 6 6

KAUFGUT[®]



Pasticceria - Backen

Tortiere Stampi



ART	BARCODE	ST.	PREZZO
01 27 92	8593419415586		8,75

STAMPO CROSTATATA VETRO Ø28CM
SIMAX

UV1	UV2	IMBALLO
1	6	1/6 CL



8 5 9 3 4 1 9 4 1 5 5 8 6



ART	BARCODE	ST.	PREZZO
01 27 93	8593419415562		8,55

STAMPO CROSTATATA VETRO Ø26CM
SIMAX

UV1	UV2	IMBALLO
1	6	1/6 CL



8 5 9 3 4 1 9 4 1 5 5 6 2



ART	BARCODE	ST.	PREZZO
04 08 60	4044935069028		11,20

TORTIERA 1 FONDO 'ENERGY'
ANTIADERENTE Ø24CM ZENKER

UV1	UV2	IMBALLO
1	3	1/3 SL



4 0 4 4 9 3 5 0 6 9 0 2 8



ART	BARCODE	ST.	PREZZO
04 08 51	4044935069035		11,90

TORTIERA 1 FONDO 'ENERGY'
ANTIADERENTE Ø26CM ZENKER

UV1	UV2	IMBALLO
1	3	1/3 SL



4 0 4 4 9 3 5 0 6 9 0 3 5



ART	BARCODE	ST.	PREZZO
04 08 52	4044935069042		12,60

TORTIERA 1 FONDO 'ENERGY'
ANTIADERENTE Ø28CM ZENKER

UV1	UV2	IMBALLO
1	3	1/3 SL



4 0 4 4 9 3 5 0 6 9 0 4 2



ART	BARCODE	ST.	PREZZO
04 08 54	4044935069080		17,30

TORTIERA 2FONDI 'ENERGY' ANTIADER.
Ø26CM ZENKER

UV1	UV2	IMBALLO
1	3	1/3 SL



4 0 4 4 9 3 5 0 6 9 0 8 0



ART	BARCODE	ST.	PREZZO
04 08 55	4044935069097		18,60

TORTIERA 2FONDI 'ENERGY' ANTIADER.
Ø28CM ZENKER

UV1	UV2	IMBALLO
1	3	1/3 SL



4 0 4 4 9 3 5 0 6 9 0 9 7



ART	BARCODE	ST.	PREZZO
04 08 56	4044935069219		5,80

STAMPO CROSTATATA 'ENERGY'
ANTIADERENTE 28CM ZENKER

UV1	UV2	IMBALLO
1	5	1/5 SL



4 0 4 4 9 3 5 0 6 9 2 1 9



ART	BARCODE	ST.	PREZZO
04 08 58	4044935069141		7,15

STAMPO PLUM CAKE 'ENERGY'
ANTIADERENTE 30CM ZENKER

UV1	UV2	IMBALLO
1	5	1/5 SL



4 0 4 4 9 3 5 0 6 9 1 4 1



ART	BARCODE	ST.	PREZZO
04 74 50*	8004537474503		11,90

STAMPO PANE/PANETTONE
'EASYCLEAN' 18X10CM EVA

UV1	UV2	IMBALLO
1	5	1/5 PB



8 0 0 4 5 3 7 4 7 4 5 0 3



ART	BARCODE	ST.	PREZZO
04 74 02*	8004537474022		6,00

TORTIERA 1FONDO 'EASYCLEAN' Ø18CM
EVA

UV1	UV2	IMBALLO
1	12	1/12 CL



8 0 0 4 5 3 7 4 7 4 0 2 2



ART	BARCODE	ST.	PREZZO
04 74 03*	8004537474039		6,20

TORTIERA 1FONDO 'EASYCLEAN' Ø20CM
EVA

UV1	UV2	IMBALLO
1	12	1/12 CL



8 0 0 4 5 3 7 4 7 4 0 3 9



ART	BARCODE	ST.	PREZZO
04 74 04	8004537474046		6,40

TORTIERA 1 FONDO 'EASYCLEAN' Ø22CM EVA

UV1	UV2	IMBALLO
1	12	1/12 CL



8 0 0 4 5 3 7 4 7 4 0 4 6



ART	BARCODE	ST.	PREZZO
04 74 05	8004537474053		6,50

TORTIERA 1 FONDO 'EASYCLEAN' Ø24CM EVA

UV1	UV2	IMBALLO
1	12	1/12 CL



8 0 0 4 5 3 7 4 7 4 0 5 3



ART	BARCODE	ST.	PREZZO
04 74 06	8004537474060		6,65

TORTIERA 1 FONDO 'EASYCLEAN' Ø26CM EVA

UV1	UV2	IMBALLO
1	12	1/12 CL



8 0 0 4 5 3 7 4 7 4 0 6 0



ART	BARCODE	ST.	PREZZO
04 74 07	8004537474077		6,90

TORTIERA 1 FONDO 'EASYCLEAN' Ø28CM EVA

UV1	UV2	IMBALLO
1	10	1/10 CL



8 0 0 4 5 3 7 4 7 4 0 7 7



ART	BARCODE	ST.	PREZZO
04 74 08	8004537474084		7,15

TORTIERA 1 FONDO 'EASYCLEAN' Ø30CM EVA

UV1	UV2	IMBALLO
1	6	1/6 CL



8 0 0 4 5 3 7 4 7 4 0 8 4



ART	BARCODE	ST.	PREZZO
04 74 12	8004537474121		8,90

TORTIERA 2 FONDI 'EASYCLEAN' Ø18CM EVA

UV1	UV2	IMBALLO
1	10	1/10 SP



8 0 0 4 5 3 7 4 7 4 1 2 1



ART	BARCODE	ST.	PREZZO
04 74 13	8004537474138		9,15

TORTIERA 2 FONDI 'EASYCLEAN' Ø20CM EVA

UV1	UV2	IMBALLO
1	8	1/8 SP



8 0 0 4 5 3 7 4 7 4 1 3 8



ART	BARCODE	ST.	PREZZO
04 74 14	8004537474145		9,70

TORTIERA 2 FONDI 'EASYCLEAN' Ø22CM EVA

UV1	UV2	IMBALLO
1	10	1/10 SP



8 0 0 4 5 3 7 4 7 4 1 4 5



ART	BARCODE	ST.	PREZZO
04 74 15	8004537474152		9,95

TORTIERA 2 FONDI 'EASYCLEAN' Ø24CM EVA

UV1	UV2	IMBALLO
1	10	1/10 SP



8 0 0 4 5 3 7 4 7 4 1 5 2



ART	BARCODE	ST.	PREZZO
04 74 16	8004537474169		10,50

TORTIERA 2 FONDI 'EASYCLEAN' Ø26CM EVA

UV1	UV2	IMBALLO
1	10	1/10 SP



8 0 0 4 5 3 7 4 7 4 1 6 9



ART	BARCODE	ST.	PREZZO
04 74 17	8004537474176		10,85

TORTIERA 2 FONDI 'EASYCLEAN' Ø28CM EVA

UV1	UV2	IMBALLO
1	8	1/8 SP



8 0 0 4 5 3 7 4 7 4 1 7 6



ART	BARCODE	ST.	PREZZO
04 74 18	8004537474183		11,50

TORTIERA 2 FONDI 'EASYCLEAN' Ø30CM EVA

UV1	UV2	IMBALLO
1	5	1/5 SP



8 0 0 4 5 3 7 4 7 4 1 8 3



ART	BARCODE	ST.	PREZZO
04 74 41*	8004537474411	A	8,50

STAMPO BUDINO 'EASYCLEAN' 18CM EVA

UV1	UV2	IMBALLO
1	5	1/10 CL



8 0 0 4 5 3 7 4 7 4 4 1 1



ART	BARCODE	ST.	PREZZO
04 74 42*	8004537474428		8,80

STAMPO BUDINO 'EASYCLEAN' 22CM EVA

UV1	UV2	IMBALLO
1	5	1/10 CL



8 0 0 4 5 3 7 4 7 4 4 2 8



ART	BARCODE	ST.	PREZZO
04 74 20*	8004537474206		4,95

STAMPO PLUM CAKE 'EASYCLEAN' 25CM EVA

UV1	UV2	IMBALLO
1	10	1/10 CL



8 0 0 4 5 3 7 4 7 4 2 0 6



ART	BARCODE	ST.	PREZZO
04 74 21*	8004537474213		5,15

STAMPO PLUM CAKE 'EASYCLEAN' 30CM EVA

UV1	UV2	IMBALLO
1	10	1/10 CL



8 0 0 4 5 3 7 4 7 4 2 1 3



ART	BARCODE	ST.	PREZZO
04 74 22*	8004537474220		5,55

STAMPO PLUM CAKE 'EASYCLEAN' 35CM EVA

UV1	UV2	IMBALLO
1	10	1/10 CL



8 0 0 4 5 3 7 4 7 4 2 2 0



ART	BARCODE	ST.	PREZZO
04 74 24*	8004537474244		6,10

STAMPO GAZZELLA 'EASYCLEAN' 30CM EVA

UV1	UV2	IMBALLO
1	10	1/10 SL



8 0 0 4 5 3 7 4 7 4 2 4 4



ART	BARCODE	ST.	PREZZO
04 74 48*	8004537474480		12,60

STAMPO PANE ALLUNGABILE 'EASYCLEAN' 28-40CM EVA

UV1	UV2	IMBALLO
1	3	1/3 CL



8 0 0 4 5 3 7 4 7 4 4 8 0



ART	BARCODE	ST.	PREZZO
04 74 36*	8004537474367		6,30

6 TARTELETTES 'EASYCLEAN' 10CM EVA

UV1	UV2	IMBALLO
1	5	1/5 HB



8 0 0 4 5 3 7 4 7 4 3 6 7



ART	BARCODE	ST.	PREZZO
04 09 39*	8004537409390		10,50

STAMPO CROSTATA/QUICHE EASYCLEAN NERO 24CM EVA

UV1	UV2	IMBALLO
1	6	1/12/72 CL



8 0 0 4 5 3 7 4 0 9 3 9 0



ART	BARCODE	ST.	PREZZO
04 09 41*	8004537409413		12,00

STAMPO CROSTATA/QUICHE EASYCLEAN NERO 28CM EVA

UV1	UV2	IMBALLO
1	6	1/12/72 CL



8 0 0 4 5 3 7 4 0 9 4 1 3



ART	BARCODE	ST.	PREZZO
04 09 42*	8004537409420		14,00

STAMPO CROSTATA/QUICHE EASYCLEAN NERO 32CM EVA

UV1	UV2	IMBALLO
1	6	1/12/48 CL



8 0 0 4 5 3 7 4 0 9 4 2 0



ART	BARCODE	ST.	PREZZO
04 74 28*	8004537474282		6,30

STAMPO CROSTATA LISCI 'EASYCLEAN' 28CM EVA

UV1	UV2	IMBALLO
1	10	1/10 CL



8 0 0 4 5 3 7 4 7 4 2 8 2



ART	BARCODE	ST.	PREZZO
04 74 26	8004537474268		3,60

STAMPO CROSTATATA EASYCLEAN 28CM EVA

UV1	UV2	IMBALLO
1	10	1/10 CL



8 0 0 4 5 3 7 4 7 4 2 6 8



ART	BARCODE	ST.	PREZZO
04 74 29	8004537474299		6,80

STAMPO CROSTATATA LISCIO 'EASYCLEAN' 30CM EVA

UV1	UV2	IMBALLO
1	10	1/10 CL



8 0 0 4 5 3 7 4 7 4 2 9 9



ART	BARCODE	ST.	PREZZO
04 74 46	8004537474466	A	10,60

TORTIERA APRIBILE 'CUORE EASYCLEAN' 24X28CM EVA

UV1	UV2	IMBALLO
1	6	1/12 CL



8 0 0 4 5 3 7 4 7 4 4 6 6



ART	BARCODE	ST.	PREZZO
04 08 46	4044935074206		12,80

TEGLIA 42 CORNETTI ANTIADERENTE 'SPECIALS' 42X32 CM ZENKER

UV1	UV2	IMBALLO
1	10	1/10 SL



4 0 4 4 9 3 5 0 7 4 2 0 6



ART	BARCODE	ST.	PREZZO
04 74 55	8004537474558		9,30

TEGLIA 12MUFFIN 'EASYCLEAN' 38X26 EVA

UV1	UV2	IMBALLO
1	12	1/12 CL



8 0 0 4 5 3 7 4 7 4 5 5 8



ART	BARCODE	ST.	PREZZO
04 09 36	8004537409369		10,00

TEGLIA 12 MINI MUFFIN ANT/AD EASYCLEAN EVA

UV1	UV2	IMBALLO
1	6	1/12/72 SL



8 0 0 4 5 3 7 4 0 9 3 6 9



ART	BARCODE	ST.	PREZZO
04 71 80	4018598661127		17,80

STAMPO 24 MINI MUFFIN ANTIADERENTE 27X35CM MAIBACK

UV1	UV2	IMBALLO
1	5	1/10 PB



4 0 1 8 5 9 8 6 6 1 1 2 7



ART	BARCODE	ST.	PREZZO
04 74 67	8004537474671		12,90

TEGLIA ALLUNGABILE ALTA 'EASYCLEAN' 34-52CM EVA

UV1	UV2	IMBALLO
1	5	1/5 CL



8 0 0 4 5 3 7 4 7 4 6 7 1



ART	BARCODE	ST.	PREZZO
04 74 66	8004537474664		12,50

TEGLIA ALLUNGABILE BASSA 'EASYCLEAN' 37-52CM EVA

UV1	UV2	IMBALLO
1	5	1/5 CL



8 0 0 4 5 3 7 4 7 4 6 6 4



ART	BARCODE	ST.	PREZZO
04 08 10	4044935070000		22,50

TORTIERA 1 FONDO DELUXE 26CM ZENKER

UV1	UV2	IMBALLO
1	3	1/3 PB



4 0 4 4 9 3 5 0 7 0 0 0 0



ART	BARCODE	ST.	PREZZO
04 08 11	4044935070017		25,50

TORTIERA 1 FONDO DELUXE 28CM ZENKER

UV1	UV2	IMBALLO
1	3	1/3 PB



4 0 4 4 9 3 5 0 7 0 0 1 7



ART	BARCODE	ST.	PREZZO
04 08 19	4044935070208		37,50

TORTIERA+PIATTO+CAMPANA DELUXE 28CM ZENKER

UV1	UV2	IMBALLO
1	3	1/3 PB



4 0 4 4 9 3 5 0 7 0 2 0 8



ART	BARCODE	ST.	PREZZO
04 08 13	4044935070048		31,50

TORTIERA 2FONDI DELUXE 26CM
ZENKER

UV1	UV2	IMBALLO
1	3	1/3 PB



4 0 4 4 9 3 5 0 7 0 0 4 8



ART	BARCODE	ST.	PREZZO
04 08 20	4044935070215		23,50

TORTIERA APRIBILE RETT DELUXE
32X23CM ZENKER

UV1	UV2	IMBALLO
1	5	1/5 PB



4 0 4 4 9 3 5 0 7 0 2 1 5



ART	BARCODE	ST.	PREZZO
04 08 21	4044935070222		27,50

TORTIERA APRIBILE RETT DELUXE
42X29CM ZENKER

UV1	UV2	IMBALLO
1	5	1/5 PB



4 0 4 4 9 3 5 0 7 0 2 2 2



ART	BARCODE	ST.	PREZZO
04 08 22	4044935070239		41,00

TORTIERA RETT+CAMPANA DELUXE
43X29CM ZENKER

UV1	UV2	IMBALLO
1	5	1/5 PB



4 0 4 4 9 3 5 0 7 0 2 3 9



ART	BARCODE	ST.	PREZZO
04 74 62*	8004537474626		14,30

TEGLIA+COPERCHIO 'EASYCLEAN'
42X29CM EVA

UV1	UV2	IMBALLO
1	5	1/5 CL



8 0 0 4 5 3 7 4 7 4 6 2 6



ART	BARCODE	ST.	PREZZO
04 08 42*	4044935060056	H	14,50

STAMPO A STELLA ANTIADERENTE
'CHRISTMAS' 25 CM ZENKER

UV1	UV2	IMBALLO
1	3	1/3 PB



4 0 4 4 9 3 5 0 6 0 0 5 6



ART	BARCODE	ST.	PREZZO
04 10 14*	4000823040661	H	4,60

STAMPO PER AGNELLO 'BLACK'
PASQUALE 20X14CM ZENKER

UV1	UV2	IMBALLO
1	10	1/10 PH



4 0 0 0 8 2 3 0 4 0 6 6 1



ART	BARCODE	ST.	PREZZO
04 10 27*	4044935091012		10,40

STAMPO AGNELLO ANTIADERENTE 1 KG
ZENKER

UV1	UV2	IMBALLO
1	5	1/5 PB



4 0 4 4 9 3 5 0 9 1 0 1 2



ART	BARCODE	ST.	PREZZO
04 08 88	8004537408881		23,50

STAMPO PANDORO BANDONE 1 KG
VITALI

UV1	UV2	IMBALLO
1	5	1/25 BK



8 0 0 4 5 3 7 4 0 8 8 8 1



ART	BARCODE	ST.	PREZZO
04 08 92*	8004537408928		33,50

STAMPO COLOMBA BANDONE 1 KG
VITALI

UV1	UV2	IMBALLO
1	5	1/1 SP



8 0 0 4 5 3 7 4 0 8 9 2 8



ART	BARCODE	ST.	PREZZO
04 71 79	4018598661134		19,90

TEGLIA FORNO PER 3 BAGUETTES
ANTIADERENTE 37X24CM MAIBACK

UV1	UV2	IMBALLO
1	5	1/10 PB



4 0 1 8 5 9 8 6 6 1 1 3 4



ART	BARCODE	ST.	PREZZO
04 10 09	4019889134757		15,90

FORMA PER 3 BAGUETTE 'FLEXIFORM'
SILICONE 36X28.5 CM LURCH

UV1	UV2	IMBALLO
1	6	1/6/24 PB



4 0 1 9 8 8 9 1 3 4 7 5 7



ART	BARCODE	ST.	PREZZO
04 12 52	8004537412529		8,80

CORNICE TORTE REGOLABILE ACCIAIO INOSSIDABILE EVA

UV1	UV2	IMBALLO
1	6	1/24 PB



8 0 0 4 5 3 7 4 1 2 5 2 9



ART	BARCODE	ST.	PREZZO
04 12 51	8004537412512	H	3,80

CORNICE TORTE REGOLABILE CUORE INOX EVA

UV1	UV2	IMBALLO
1	6	1/6/72 SL



8 0 0 4 5 3 7 4 1 2 5 1 2



ART	BARCODE	ST.	PREZZO
04 12 31	4004094313165		9,30

ANELLO TORTA ACCIAIO INOSSIDABILE H 8,5/Ø 16-30 CM WESTMARK

UV1	UV2	IMBALLO
1	5	1/5/10 HB



4 0 0 4 0 9 4 3 1 3 1 6 5



ART	BARCODE	ST.	PREZZO
04 12 50	8004537412505		7,90

ANELLO TORTE ACCIAIO INOSSIDABILE Ø16 30CM H 8,5CM EVA

UV1	UV2	IMBALLO
1	12	1/36 PB



8 0 0 4 5 3 7 4 1 2 5 0 5



ART	BARCODE	ST.	PREZZO
04 12 33	4003244060089		19,50

ANELLO TORTA APRIBILE ACCIAIO INOSSIDABILE H 7/Ø 17-30 CM

UV1	UV2	IMBALLO
1	2	1/10 PB



4 0 0 3 2 4 4 0 6 0 0 8 9



ART	BARCODE	ST.	PREZZO
04 12 34	4003244060034		22,50

ANELLO TORTA APRIBILE ACCIAIO INOSSIDABILE H 10/Ø 17-30 CM

UV1	UV2	IMBALLO
1	2	1/6 PB



4 0 0 3 2 4 4 0 6 0 0 3 4



ART	BARCODE	ST.	PREZZO
04 12 45	4003244060300		35,00

ANELLO TORTA APRIBILE ACCIAIO INOSSIDABILE H 15/Ø 17-30 CM

UV1	UV2	IMBALLO
1	2	1/12 PB



4 0 0 3 2 4 4 0 6 0 3 0 0



ART	BARCODE	ST.	PREZZO
04 12 46	4003244060188		38,50

ANELLO TORTA APRIBILE ACCIAIO INOSSIDABILE H 20/Ø 17-30 CM

UV1	UV2	IMBALLO
1	2	1/4 PB



4 0 0 3 2 4 4 0 6 0 1 8 8



ART	BARCODE	ST.	PREZZO
04 10 03	4019889129678		24,50

TORTIERA APRIBILE 'FLEXIFORM' SILICONE/VETRO 26CM LURCH

UV1	UV2	IMBALLO
1	3	1/3/12 PB



4 0 1 9 8 8 9 1 2 9 6 7 8



ART	BARCODE	ST.	PREZZO
04 10 10	4019889120743		20,90

STAMPO BUDINO 'FLEXIFORM' SILICONE 22CM LURCH

UV1	UV2	IMBALLO
1	6	1/6/24 PB



4 0 1 9 8 8 9 1 2 0 7 4 3



ART	BARCODE	ST.	PREZZO
04 10 04	4019889120774		24,50

STAMPO PLUM CAKE 'FLEXIFORM' SILICONE 30CM LURCH

UV1	UV2	IMBALLO
1	6	1/6/24 PB



4 0 1 9 8 8 9 1 2 0 7 7 4



ART	BARCODE	ST.	PREZZO
04 10 05	4019889120804		20,00

STAMPO 12 MUFFIN 'FLEXIFORM' SILICONE 25X33,5 CM LURCH

UV1	UV2	IMBALLO
1	6	1/6/24 PB



4 0 1 9 8 8 9 1 2 0 8 0 4



ART	BARCODE	ST.	PREZZO
04 10 06	4019889136355		13,50

FORMA 12 PANINI HAMBURGER 'SIZE S-FLEXIFORM' SILICONE LURCH

UV1	UV2	IMBALLO
1	6	1/6/24 PB



4 0 1 9 8 8 9 1 3 6 3 5 5



ART	BARCODE	ST.	PREZZO
04 10 07	4019889135525		15,30

FORMA 6 PANINI HAMBURGER 'SIZE M-FLEXIFORM' SILICONE LURCH

UV1	UV2	IMBALLO
1	6	1/6/24 PB



4 0 1 9 8 8 9 1 3 5 5 2 5



ART	BARCODE	ST.	PREZZO
04 08 84	8004537408843		3,60

FORMA CREME CARAMEL ACCIAIO INOSSIDABILE 7CM EVA

UV1	UV2	IMBALLO
1	24	1/24/240 AL



8 0 0 4 5 3 7 4 0 8 8 4 3



ART	BARCODE	ST.	PREZZO
08 18 31	4009290064569		3,25

STAMPO SOUFFLE' ROTONDO BIANCO Ø10CM

UV1	UV2	IMBALLO
1	6	1/6/36 BK



4 0 0 9 2 9 0 0 6 4 5 6 9



ART	BARCODE	ST.	PREZZO
04 71 44*	4018598330061	H	9,20

100 PIROTTINI CIOCCOLATINI CONICI ALLUMINIO MAIBACK

UV1	UV2	IMBALLO
1	10	1/10 PB



4 0 1 8 5 9 8 3 3 0 0 6 1



ART	BARCODE	ST.	PREZZO
04 08 73	8032793250197		1,55

6 STAMPI PER CANNOLI SICILIANI BANDONE 80X15 MM

UV1	UV2	IMBALLO
1	10	1/250 SP



8 0 3 2 7 9 3 2 5 0 1 9 7



ART	BARCODE	ST.	PREZZO
04 08 74	8032793250180		1,95

6 STAMPI PER CANNOLI ROMANI BANDONE 120X25 MM

UV1	UV2	IMBALLO
1	10	1/90 SP



8 0 3 2 7 9 3 2 5 0 1 8 0



ART	BARCODE	ST.	PREZZO
04 08 75	8032793250173		1,70

6 STAMPI PER CANNOLI SGUSCIATI BANDONE 120X25MM

UV1	UV2	IMBALLO
1	10	1/100 SP



8 0 3 2 7 9 3 2 5 0 1 7 3



ART	BARCODE	ST.	PREZZO
04 08 80	8004537408805		3,40

6 CONI PANNA BANDONE 120X35MM EVA

UV1	UV2	IMBALLO
1	12	1/12/144 BC



8 0 0 4 5 3 7 4 0 8 8 0 5



ART	BARCODE	ST.	PREZZO
04 10 51	8004537410518		2,00

150 PIROTTINI CARTA BIANCHI 3,5CM EVA

UV1	UV2	IMBALLO
1	12	1/12/216 BC



8 0 0 4 5 3 7 4 1 0 5 1 8



ART	BARCODE	ST.	PREZZO
04 10 52	8004537410525		2,00

75 PIROTTINI CARTA BIANCHI 6CM EVA

UV1	UV2	IMBALLO
1	12	1/12/216 BC



8 0 0 4 5 3 7 4 1 0 5 2 5



ART	BARCODE	ST.	PREZZO
04 10 63	4044935077108		4,45

200 PIROTTINI BIANCHI CARTA Ø5CM ZENKER

UV1	UV2	IMBALLO
1	18	1/18 HB



4 0 4 4 9 3 5 0 7 7 1 0 8



ART	BARCODE	ST.	PREZZO
04 70 81	4018598335370		3,05

50 PIROTTINI CARTA MAXI 'FIORE' Ø5CM MAIBACK

UV1	UV2	IMBALLO
1	12	1/12/144 PV



4 0 1 8 5 9 8 3 3 5 3 7 0



ART	BARCODE	ST.	PREZZO
04 70 83	4018598335400		3,05

50 PIROTTINI CARTA MAXI 'LINEE' Ø5CM MAIBACK

UV1	UV2	IMBALLO
1	12	1/12/144 PV



4 0 1 8 5 9 8 3 3 5 4 0 0



ART	BARCODE	ST.	PREZZO
04 70 84	4018598335387		3,05

50 PIROTTINI CARTA MAXI 'QUADRIFOGLIO' Ø5CM MAIBACK

UV1	UV2	IMBALLO
1	12	1/12/144 PV



4 0 1 8 5 9 8 3 3 5 3 8 7



ART	BARCODE	ST.	PREZZO
04 70 90	4018598335226		3,05

50 PIROTTINI CARTA MAXI 'CUORI' Ø5CM MAIBACK

UV1	UV2	IMBALLO
1	12	1/12/144 PV



4 0 1 8 5 9 8 3 3 5 2 2 6



ART	BARCODE	ST.	PREZZO
04 10 58	8004537410587		9,25

12 PIROTTINI SILICONE 8CM EVA

UV1	UV2	IMBALLO
1	12	1/12/48 PV



8 0 0 4 5 3 7 4 1 0 5 8 7



ART	BARCODE	ST.	PREZZO
04 10 66	4008871201898		3,65

CARTA DA FORNO SILICONATA ROTOLO 14 FOGLI 38X42CM

UV1	UV2	IMBALLO
1	20	1/20 PB



4 0 0 8 8 7 1 2 0 1 8 9 8

Taglia biscotti



ART	BARCODE	ST.	PREZZO
04 10 95	8004537410952		3,70

6 TAGLIAPASTA ROTONDI COLORI ASSORTITI EVA

UV1	UV2	IMBALLO
1	12	1/12/72 PV



8 0 0 4 5 3 7 4 1 0 9 5 2



ART	BARCODE	ST.	PREZZO
04 10 99	8004537410990	A	3,50

5 TAGLIAPASTA STELLA COLORI ASSORTITI EVA

UV1	UV2	IMBALLO
1	12	1/12/72 PV



8 0 0 4 5 3 7 4 1 0 9 9 0



ART	BARCODE	ST.	PREZZO
04 11 76*	4003244010190	H	0,33

TAGLIABISCOTTI NATALE BANDONE IN DISPLAY

UV1	UV2	IMBALLO
300	600	1/300 DB



4 0 0 3 2 4 4 0 1 0 1 9 0



ART	BARCODE	ST.	PREZZO
04 12 65	4003244010138		3,50

6 TAGLIABISCOTTI NATALE MINI BANDONE

UV1	UV2	IMBALLO
1	10	1/10/250 BC



4 0 0 3 2 4 4 0 1 0 1 3 8



ART	BARCODE	ST.	PREZZO
04 12 69	4003244010107		3,50

6 TAGLIABISCOTTI NATALE BANDONE Ø 5CM

UV1	UV2	IMBALLO
1	10	1/10/200 BC



4 0 0 3 2 4 4 0 1 0 1 0 7



ART	BARCODE	ST.	PREZZO
04 12 14*	4013291400400	H	5,90

STENCIL TAGLIABISCOTTI ABS ASSORTITI 30X21CM

UV1	UV2	IMBALLO
1	10	1/10 SP



4 0 1 3 2 9 1 4 0 0 4 0 0



ART	BARCODE	ST.	PREZZO
04 12 24	8004537412246		5,50

3 TAGLIAPASTA FESTONATI ACCIAIO INOSSIDABILE 5/7/8 CM EVA

UV1	UV2	IMBALLO
1	12	1/12/144 CD



8 0 0 4 5 3 7 4 1 2 2 4 6



ART	BARCODE	ST.	PREZZO
04 12 28	8004537412284		5,50

3 TAGLIAPASTA LISCI ACCIAIO INOSSIDABILE 6/7/8 CM EVA

UV1	UV2	IMBALLO
1	12	1/12/144 CD



8 0 0 4 5 3 7 4 1 2 2 8 4



ART	BARCODE	ST.	PREZZO
04 12 29	4044935077306		6,10

12 TAGLIAPASTA BANDONE 4-8CM ZENKER

UV1	UV2	IMBALLO
1	10	1/20 HB



4 0 4 4 9 3 5 0 7 7 3 0 6



ART	BARCODE	ST.	PREZZO
04 12 37	8004537412376	A	4,50

TAGLIABISCOTTI TONDO FEST 3FORI BANDONE 5CM EVA

UV1	UV2	IMBALLO
1	12	1/12/144 BC



8 0 0 4 5 3 7 4 1 2 3 7 6



ART	BARCODE	ST.	PREZZO
04 12 38	8004537412383	A	4,95

TAGLIABISCOTTI TONDO FEST 3FORI BANDONE 6,5CM EVA

UV1	UV2	IMBALLO
1	12	1/12/72 BC



8 0 0 4 5 3 7 4 1 2 3 8 3



ART	BARCODE	ST.	PREZZO
04 12 39*	8004537412390	H	5,10

TAGLIABISCOTTI TONDO FEST 3FORI BANDONE 7,5CM EVA

UV1	UV2	IMBALLO
1	12	1/12/72 BC



8 0 0 4 5 3 7 4 1 2 3 9 0



ART	BARCODE	ST.	PREZZO
04 12 43	4011109954107		4,55

TAGLIAPASTA 'SPITZBUB' LISCIO
PLASTICA Ø4 CM MAIBACK

UV1	UV2	IMBALLO
1	5	1/10/100 BC



4 0 1 1 1 0 9 9 5 4 1 0 7



ART	BARCODE	ST.	PREZZO
04 12 44	4011109954206		4,55

TAGLIAPASTA 'SPITZBUB' FESTONATO
PLASTICA Ø4 CM MAIBACK

UV1	UV2	IMBALLO
1	5	1/10/100 BC



4 0 1 1 1 0 9 9 5 4 2 0 6



ART	BARCODE	ST.	PREZZO
04 12 58	8004537412581		4,25

6 TAGLIABISCOTTI 'NATALE' ACCIAIO
INOSSIDABILE EVA

UV1	UV2	IMBALLO
1	12	1/12/144 BC



8 0 0 4 5 3 7 4 1 2 5 8 1



ART	BARCODE	ST.	PREZZO
04 12 62	4003244010121		5,90

12 TAGLIABISCOTTI NATALE MINI
BANDONE

UV1	UV2	IMBALLO
1	10	1/10/140 BC



4 0 0 3 2 4 4 0 1 0 1 2 1



ART	BARCODE	ST.	PREZZO
04 12 75	8004537412758	H	8,55

9 TAGLIABISCOTTI BOX 'NUMERI'
ACCIAIO INOSSIDABILE EVA

UV1	UV2	IMBALLO
1	6	1/12/72 SP



8 0 0 4 5 3 7 4 1 2 7 5 8



ART	BARCODE	ST.	PREZZO
04 12 81	8004537412819	H	8,20

BOX 9 TAGLIABISCOTTI 'NUMERI'
ACCIAIO INOSSIDABILE EVA

UV1	UV2	IMBALLO
1	12	1/12/144 SP



8 0 0 4 5 3 7 4 1 2 8 1 9



ART	BARCODE	ST.	PREZZO
04 12 96	8004537412963		12,50

11 STAMPINI BOX LISCI ACCIAIO
INOSSIDABILE EVA

UV1	UV2	IMBALLO
1	12	1/12/72 SP



8 0 0 4 5 3 7 4 1 2 9 6 3



ART	BARCODE	ST.	PREZZO
04 12 98	8004537412987		13,00

11 STAMPINI BOX 'FESTONATI' ACCIAIO
INOSSIDABILE EVA

UV1	UV2	IMBALLO
1	12	1/12/72 SP



8 0 0 4 5 3 7 4 1 2 9 8 7



ART	BARCODE	ST.	PREZZO
04 66 39	4028574008150		13,25

TAGLIAPASTA PER CIAMBELLE 8CM
SCHNEIDER

UV1	UV2	IMBALLO
1	5	1/10 BK



4 0 2 8 5 7 4 0 0 8 1 5 0



ART	BARCODE	ST.	PREZZO
04 08 45	4044935077429	H	10,50

BOX IN PAP CON 18 TAGLIABISCOTTI
BANDONE 'CHRISTMAS' ZENKER

UV1	UV2	IMBALLO
1	6	1/6 SL



4 0 4 4 9 3 5 0 7 7 4 2 9



ART	BARCODE	ST.	PREZZO
04 57 01	4004094362019	A	1,25

TAGLIABISCOTTI CAT. GIALLA
"ELEFANTE" INOX 5CM WESTMARK

UV1	UV2	IMBALLO
6	12	1/6/144 BK



4 0 0 4 0 9 4 3 6 2 0 1 9



ART	BARCODE	ST.	PREZZO
04 57 02	4004094361715		1,30

TAGLIABISCOTTI CAT. GIALLA
"OCA/ANATRA" INOX 6CM WESTMARK

UV1	UV2	IMBALLO
6	12	1/6/144 BK



4 0 0 4 0 9 4 3 6 1 7 1 5



ART	BARCODE	ST.	PREZZO
04 57 03	4004094361012		1,30

TAGLIABISCOTTI CAT. GIALLA
"CAVALLO" INOX 6CM WESTMARK

UV1	UV2	IMBALLO
6	12	1/6/144 BK



4 0 0 4 0 9 4 3 6 1 0 1 2



ART	BARCODE	ST.	PREZZO
04 57 04*	4004094362217		1,30

TAGLIABISCOTTI CAT. GIALLA
"CONIGLIO" INOX 5CM WESTMARK

UV1	UV2	IMBALLO
6	12	1/6/144 BK



4 0 0 4 0 9 4 3 6 2 2 1 7



ART	BARCODE	ST.	PREZZO
04 57 05*	4004094362415		1,30

TAGLIABISCOTTI CAT. GIALLA
"AGNELLO" INOX 5CM WESTMARK

UV1	UV2	IMBALLO
6	12	1/6/144 BK



4 0 0 4 0 9 4 3 6 2 4 1 5



ART	BARCODE	ST.	PREZZO
04 57 06	4004094360213		1,30

TAGLIABISCOTTI CAT. GIALLA
"GATTO SEDUTO" INOX 5CM WESTMARK

UV1	UV2	IMBALLO
6	12	1/6/144 BK



4 0 0 4 0 9 4 3 6 0 2 1 3



ART	BARCODE	ST.	PREZZO
04 57 10	4004094360619		1,30

TAGLIABISCOTTI CAT. GIALLA
"ORSETTO" INOX 6CM WESTMARK

UV1	UV2	IMBALLO
6	12	1/6/144 BK



4 0 0 4 0 9 4 3 6 0 6 1 9



ART	BARCODE	ST.	PREZZO
04 57 11	4004094364618		1,30

TAGLIABISCOTTI CAT. GIALLA
"MAIALINO" INOX 6CM WESTMARK

UV1	UV2	IMBALLO
6	12	1/6/144 BK



4 0 0 4 0 9 4 3 6 4 6 1 8



ART	BARCODE	ST.	PREZZO
04 57 12	4004094365011		1,30

TAGLIABISCOTTI CAT. GIALLA
"QUADRIFOGLIO" INOX 6CM WESTMARK

UV1	UV2	IMBALLO
6	12	1/6/144 BK



4 0 0 4 0 9 4 3 6 5 0 1 1



ART	BARCODE	ST.	PREZZO
04 57 15	4004094368012		1,30

TAGLIABISCOTTI CAT. GIALLA
"FANTASMA" INOX 7CM WESTMARK

UV1	UV2	IMBALLO
6	12	1/6/144 BK



4 0 0 4 0 9 4 3 6 8 0 1 2



ART	BARCODE	ST.	PREZZO
04 57 16	4004094366017	A	1,25

TAGLIABISCOTTI CAT. GIALLA
"PIEDE" INOX 6,5CM WESTMARK

UV1	UV2	IMBALLO
6	12	1/6/144 BK



4 0 0 4 0 9 4 3 6 6 0 1 7



ART	BARCODE	ST.	PREZZO
04 57 17	4004094365416		1,30

TAGLIABISCOTTI CAT. GIALLA
"CUORE" INOX 6CM WESTMARK

UV1	UV2	IMBALLO
6	12	1/6/144 BK



4 0 0 4 0 9 4 3 6 5 4 1 6



ART	BARCODE	ST.	PREZZO
04 57 18	4004094365713		1,30

TAGLIABISCOTTI CAT. GIALLA
"ROSETTA" INOX 5CM WESTMARK

UV1	UV2	IMBALLO
6	12	1/6/144 BK



4 0 0 4 0 9 4 3 6 5 7 1 3



ART	BARCODE	ST.	PREZZO
04 57 19	4004094365218		1,30

TAGLIABISCOTTI CAT. GIALLA
"NOTA MUSICALE" INOX 7CM WESTMARK

UV1	UV2	IMBALLO
6	12	1/6/144 BK



4 0 0 4 0 9 4 3 6 5 2 1 8



ART	BARCODE	ST.	PREZZO
04 57 20	4004094367014		1,30

TAGLIABISCOTTI CAT. GIALLA
"CHITARRA" INOX 7CM WESTMARK

UV1	UV2	IMBALLO
6	12	1/6/144 BK



4 0 0 4 0 9 4 3 6 7 0 1 4



ART	BARCODE	ST.	PREZZO
04 57 21	4004094356414		1,30

TAGLIABISCOTTI CAT. GIALLA "RENNA"
INOX 6CM WESTMARK

UV1	UV2	IMBALLO
6	12	1/6/144 BK



4 0 0 4 0 9 4 3 5 6 4 1 4



ART	BARCODE	ST.	PREZZO
04 57 22	4004094355615		1,30

TAGLIABISCOTTI CAT. GIALLA "ABETE"
INOX 6CM WESTMARK

UV1	UV2	IMBALLO
6	12	1/6/144 BK



4 0 0 4 0 9 4 3 5 5 6 1 5



ART	BARCODE	ST.	PREZZO
04 57 23	4004094357213		1,30

TAGLIABISCOTTI CAT. GIALLA "PUPAZZO
DI NEVE" INOX 6CM WESTM

UV1	UV2	IMBALLO
6	12	1/6/144 BK



4 0 0 4 0 9 4 3 5 7 2 1 3



ART	BARCODE	ST.	PREZZO
04 57 24	4004094356612		1,30

TAGLIABISCOTTI CAT. GIALLA
"GINGERMAN" INOX 6CM WESTMARK

UV1	UV2	IMBALLO
6	12	1/6/144 BK



4 0 0 4 0 9 4 3 5 6 6 1 2



ART	BARCODE	ST.	PREZZO
04 57 25	4004094355219		1,30

TAGLIABISCOTTI CAT. GIALLA "STELLA"
INOX 6CM WESTMARK

UV1	UV2	IMBALLO
6	12	1/6/144 BK



4 0 0 4 0 9 4 3 5 5 2 1 9



ART	BARCODE	ST.	PREZZO
04 57 26	4004094355813		1,30

TAGLIABISCOTTI CAT. GIALLA
"COMETA" INOX 7CM WESTMARK

UV1	UV2	IMBALLO
6	12	1/6/144 BK



4 0 0 4 0 9 4 3 5 5 8 1 3



ART	BARCODE	ST.	PREZZO
04 57 27	4004094355417		1,30

TAGLIABISCOTTI CAT. GIALLA "MEZZA
LUNA" INOX 6CM WESTMARK

UV1	UV2	IMBALLO
6	12	1/6/144 BK



4 0 0 4 0 9 4 3 5 5 4 1 7



ART	BARCODE	ST.	PREZZO
04 57 28	4004094356018		1,30

TAGLIABISCOTTI CAT. GIALLA "ANGELO"
INOX 6CM WESTMARK

UV1	UV2	IMBALLO
6	12	1/6/144 BK



4 0 0 4 0 9 4 3 5 6 0 1 8



ART	BARCODE	ST.	PREZZO
04 57 29	4004094356216		1,30

TAGLIABISCOTTI CAT. GIALLA
"CAMPANA" INOX 6CM WESTMARK

UV1	UV2	IMBALLO
6	12	1/6/144 BK



4 0 0 4 0 9 4 3 5 6 2 1 6



ART	BARCODE	ST.	PREZZO
04 57 52	4004094361210		1,90

TAGLIABISCOTTI CAT. ROSSA
"FARFALLA" INOX 6CM WESTMARK

UV1	UV2	IMBALLO
6	12	1/6/144 BK



4 0 0 4 0 9 4 3 6 1 2 1 0



ART	BARCODE	ST.	PREZZO
04 57 53	4004094362514		1,90

TAGLIABISCOTTI CAT. ROSSA
"PECORELLA" INOX 6,5CM WESTMARK

UV1	UV2	IMBALLO
6	12	1/6/144 BK



4 0 0 4 0 9 4 3 6 2 5 1 4



ART	BARCODE	ST.	PREZZO
04 57 64	4004094360114	A	1,85

TAGLIABISCOTTI CAT. ROSSA "LAMA" INOX 9CM WESTMARK

UV1	UV2	IMBALLO
6	12	1/6/144 BK



4 0 0 4 0 9 4 3 6 0 1 1 4



ART	BARCODE	ST.	PREZZO
04 57 56	4004094362613	A	1,85

TAGLIABISCOTTI CAT. ROSSA "UCCELLO" INOX 6CM WESTMARK

UV1	UV2	IMBALLO
6	12	1/6/144 BK



4 0 0 4 0 9 4 3 6 2 6 1 3



ART	BARCODE	ST.	PREZZO
04 57 65	4004094360510	A	1,85

TAGLIABISCOTTI CAT. ROSSA "FENICOTTERO" INOX 10,5CM WESTMARK

UV1	UV2	IMBALLO
6	12	1/6/144 BK



4 0 0 4 0 9 4 3 6 0 5 1 0



ART	BARCODE	ST.	PREZZO
04 57 57	4004094365614		1,90

TAGLIABISCOTTI CAT. ROSSA "CUORE DOPPIO" INOX 6,5CM WESTMARK

UV1	UV2	IMBALLO
6	12	1/6/144 BK



4 0 0 4 0 9 4 3 6 5 6 1 4



ART	BARCODE	ST.	PREZZO
04 57 58	4004094367311		1,90

TAGLIABISCOTTI CAT. ROSSA "ROSETTA+CUORE" INOX 6,5CM WESTMA

UV1	UV2	IMBALLO
6	12	1/6/144 BK



4 0 0 4 0 9 4 3 6 7 3 1 1



ART	BARCODE	ST.	PREZZO
04 57 60	4004094369810	A	1,85

TAGLIABISCOTTI CAT. ROSSA "DRAGO ALATO" INOX 6CM WESTMARK

UV1	UV2	IMBALLO
6	12	1/6/144 BK



4 0 0 4 0 9 4 3 6 9 8 1 0



ART	BARCODE	ST.	PREZZO
04 57 61	4004094354212		1,90

TAGLIABISCOTTI CAT. ROSSA "ABETE" INOX 8CM WESTMARK

UV1	UV2	IMBALLO
6	12	1/6/144 BK



4 0 0 4 0 9 4 3 5 4 2 1 2



ART	BARCODE	ST.	PREZZO
04 57 62	4004094356810		1,90

TAGLIABISCOTTI CAT. ROSSA "GINGERMAN" INOX 8CM WESTMARK

UV1	UV2	IMBALLO
6	12	1/6/144 BK



4 0 0 4 0 9 4 3 5 6 8 1 0



ART	BARCODE	ST.	PREZZO
04 57 63	4004094357015		1,90

TAGLIABISCOTTI CAT. ROSSA "FIOCCO DI NEVE" INOX 6CM WESTMARK

UV1	UV2	IMBALLO
6	12	1/6/144 BK



4 0 0 4 0 9 4 3 5 7 0 1 5



ART	BARCODE	ST.	PREZZO
04 58 01	4004094363719		2,85

TAGLIABISCOTTI CAT. BLU "TRATTORE 2D" INOX 6CM WESTMARK

UV1	UV2	IMBALLO
6	12	1/6/144 BK



4 0 0 4 0 9 4 3 6 3 7 1 9



ART	BARCODE	ST.	PREZZO
04 58 02	4004094363511	A	2,80

TAGLIABISCOTTI CAT. BLU "POMPIERI 2D" INOX 6CM WESTMARK

UV1	UV2	IMBALLO
6	12	1/6/144 BK



4 0 0 4 0 9 4 3 6 3 5 1 1



ART	BARCODE	ST.	PREZZO
04 58 05	4004094369117		2,85

TAGLIABISCOTTI CAT. BLU "UNICORNO" INOX 5CM WESTMARK

UV1	UV2	IMBALLO
6	12	1/6/144 BK



4 0 0 4 0 9 4 3 6 9 1 1 7



ART	BARCODE	ST.	PREZZO
04 58 06	4004094367915		2,85

TAGLIABISCOTTI CAT. BLU
"ROSETTA+CERCHIO" INOX 5,5CM
WESTMA

UV1	UV2	IMBALLO
6	12	1/6/144 BK



4 0 0 4 0 9 4 3 6 7 9 1 5



ART	BARCODE	ST.	PREZZO
04 58 07	4004094367519		2,85

TAGLIABISCOTTI CAT. BLU
"ROSETTA+SMILE" INOX 6,5CM
WESTMARK

UV1	UV2	IMBALLO
6	12	1/6/144 BK



4 0 0 4 0 9 4 3 6 7 5 1 9



ART	BARCODE	ST.	PREZZO
04 58 08	4004094352010		2,85

TAGLIABISCOTTI CAT. BLU 3 PZ "TONDI
LISCI" INOX 4,5,6CM WEST

UV1	UV2	IMBALLO
6	12	1/6/96 BK



4 0 0 4 0 9 4 3 5 2 0 1 0



ART	BARCODE	ST.	PREZZO
04 58 09	4004094352119		2,85

TAGLIABISCOTTI CAT. BLU 3 PZ "TONDI
FEST" INOX 4,5,6CM WEST

UV1	UV2	IMBALLO
6	12	1/6/96 BK



4 0 0 4 0 9 4 3 5 2 1 1 9



ART	BARCODE	ST.	PREZZO
04 58 10	4004094352218		2,85

TAGLIABISCOTTI CAT. BLU 3 PZ
"STELLA" INOX 4,5,6CM WESTMARK

UV1	UV2	IMBALLO
6	12	1/6/96 BK



4 0 0 4 0 9 4 3 5 2 2 1 8



ART	BARCODE	ST.	PREZZO
04 58 11	4004094352416		2,85

TAGLIABISCOTTI CAT. BLU 3 PZ
"CUORE" INOX 2,3,4CM WESTMARK

UV1	UV2	IMBALLO
6	12	1/6/96 BK



4 0 0 4 0 9 4 3 5 2 4 1 6



ART	BARCODE	ST.	PREZZO
04 58 12	4004094352515		2,85

TAGLIABISCOTTI CAT. BLU 3 PZ
"CUORE" INOX 4,5,6CM WESTMARK

UV1	UV2	IMBALLO
6	12	1/6/96 BK



4 0 0 4 0 9 4 3 5 2 5 1 5



ART	BARCODE	ST.	PREZZO
04 58 13	4004094352614		2,85

TAGLIABISCOTTI CAT. BLU 3 PZ
"ROSETTA" INOX 4,5,6CM WESTMARK

UV1	UV2	IMBALLO
6	12	1/6/96 BK



4 0 0 4 0 9 4 3 5 2 6 1 4

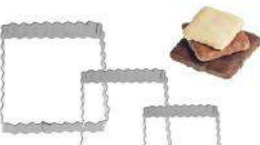

ART	BARCODE	ST.	PREZZO
04 58 14	4004094352713		2,85

TAGLIABISCOTTI CAT. BLU 3 PZ "QUADRI
FESTONATI" INOX 4,5,6CM

UV1	UV2	IMBALLO
6	12	1/6/96 BK



4 0 0 4 0 9 4 3 5 2 7 1 3



ART	BARCODE	ST.	PREZZO
04 58 16	4004094355318		2,85

TAGLIABISCOTTI CAT. BLU "ABETE"
INOX 7CM WESTMARK

UV1	UV2	IMBALLO
6	12	1/6/144 BK



4 0 0 4 0 9 4 3 5 5 3 1 8



ART	BARCODE	ST.	PREZZO
04 58 17	4004094356513		2,85

TAGLIABISCOTTI CAT. BLU
"ALCE/RENNA" INOX 7,5CM WESTMARK

UV1	UV2	IMBALLO
6	12	1/6/144 BK



4 0 0 4 0 9 4 3 5 6 5 1 3



ART	BARCODE	ST.	PREZZO
04 58 18	4004094355912		2,85

TAGLIABISCOTTI CAT. BLU "ANGELO 2D"
INOX 6CM WESTMARK

UV1	UV2	IMBALLO
6	12	1/6/144 BK



4 0 0 4 0 9 4 3 5 5 9 1 2



ART	BARCODE	ST.	PREZZO
04 58 56	4004094368912	A	4,25

TAGLIABISCOTTI INOX CAT. VERDE "UNICORNO" 8,5CM WESTMARK

UV1	UV2	IMBALLO
6	12	1/6/144 BK



4 0 0 4 0 9 4 3 6 8 9 1 2



ART	BARCODE	ST.	PREZZO
04 58 51	4004094354311		4,35

TAGLIABISCOTTI CAT. VERDE "FERRO CAVALLO 2D" INOX 6CM WESTMA

UV1	UV2	IMBALLO
6	12	1/6/144 BK



4 0 0 4 0 9 4 3 5 4 3 1 1



ART	BARCODE	ST.	PREZZO
04 58 52	4004094350214		4,35

TAGLIABISCOTTI CAT. VERDE "STELLA LINZER" INOX 5CM WESTMARK

UV1	UV2	IMBALLO
6	12	1/6/144 BK



4 0 0 4 0 9 4 3 5 0 2 1 4



ART	BARCODE	ST.	PREZZO
04 58 53	4004094350610		4,35

TAGLIABISCOTTI CAT. VERDE "ROSETTA LINZER" INOX 5CM WESTMARK

UV1	UV2	IMBALLO
6	12	1/6/144 BK



4 0 0 4 0 9 4 3 5 0 6 1 0



ART	BARCODE	ST.	PREZZO
04 58 54	4004094350412		4,35

TAGLIABISCOTTI CAT. VERDE "CUORE LINZER" INOX 5CM WESTMARK

UV1	UV2	IMBALLO
6	12	1/6/144 BK



4 0 0 4 0 9 4 3 5 0 4 1 2



ART	BARCODE	ST.	PREZZO
04 58 55	4004094350016		4,35

TAGLIABISCOTTI CAT. VERDE "BREZEL LINZER" INOX 5CM WESTMARK

UV1	UV2	IMBALLO
6	12	1/6/144 BK



4 0 0 4 0 9 4 3 5 0 0 1 6



ART	BARCODE	ST.	PREZZO
04 58 76*	4004094319563		7,95

TAGLIABISCOTTI 6 PZ ASSORTITI "PASQUA" INOX WESTMARK

UV1	UV2	IMBALLO
1	6	1/6/48 HB



4 0 0 4 0 9 4 3 1 9 5 6 3



ART	BARCODE	ST.	PREZZO
04 58 77	4004094319266		6,80

TAGLIABISCOTTI 6 PZ ASSORTITI "ANIMALS" INOX WESTMARK

UV1	UV2	IMBALLO
1	6	1/6/48 HB



4 0 0 4 0 9 4 3 1 9 2 6 6



ART	BARCODE	ST.	PREZZO
04 58 78	4004094319365		8,90

TAGLIABISCOTTI 4 PZ ASSORT. "FORTUNA&AMORE" INOX WESTMARK

UV1	UV2	IMBALLO
1	6	1/6/48 HB



4 0 0 4 0 9 4 3 1 9 3 6 5



ART	BARCODE	ST.	PREZZO
04 58 79	4004094319464		9,90

TAGLIABISCOTTI 4 PZ ASSORTITI "HALLOWEEN" INOX WESTMARK

UV1	UV2	IMBALLO
1	6	1/6/48 HB



4 0 0 4 0 9 4 3 1 9 4 6 4



ART	BARCODE	ST.	PREZZO
04 58 82	4004094319167		6,90

TAGLIABISCOTTI 6 PZ ASSORTITI "NATALE" INOX WESTMARK

UV1	UV2	IMBALLO
1	6	1/6/48 HB



4 0 0 4 0 9 4 3 1 9 1 6 7



ART	BARCODE	ST.	PREZZO
04 58 83	4004094319969	A	9,50

TAGLIABISCOTTI 6 PZ "CASETTA DI PAN PEPATO" INOX WESTMARK

UV1	UV2	IMBALLO
1	6	1/6/24 HB



4 0 0 4 0 9 4 3 1 9 9 6 9



ART	BARCODE	ST.	PREZZO
04 58 84	4004094008733		1,30

TAGLIABISCOTTI ASSORTITI "NATALE" INOX IN DISPLAY WESTMARK

UV1	UV2	IMBALLO
200	400	1/200/400 DB



4 0 0 4 0 9 4 0 0 8 7 3 3



ART	BARCODE	ST.	PREZZO
04 58 98	4051735050415		75,00

DISPLAY DA BANCO PER TAGLIABISCOTTI WESTMARK

UV1	UV2	IMBALLO
1	2	1/1 BX



4 0 5 1 7 3 5 0 5 0 4 1 5



ART	BARCODE	ST.	PREZZO
04 58 99	4051735050576		200,00

DISPLAY ALTO PER TAGLIABISCOTTI WESTMARK

UV1	UV2	IMBALLO
1	2	1/1 BX



4 0 5 1 7 3 5 0 5 0 5 7 6

Pennelli Spatole cucchiai



ART	BARCODE	ST.	PREZZO
04 11 38	4004094322075		1,65

**PENNELLO PASTICCERIA
LEGNO/SETOLA NATURALE 1"**
WESTMARK

UV1	UV2	IMBALLO
1	10	1/10/500 CD



4 0 0 4 0 9 4 3 2 2 0 7 5



ART	BARCODE	ST.	PREZZO
04 11 46	4004094322273		2,65

**PENNELLO PASTICCERIA
LEGNO/SETOLA NATURALE 1,5"**
WESTMARK

UV1	UV2	IMBALLO
1	10	1/10/70 CD



4 0 0 4 0 9 4 3 2 2 2 7 3



ART	BARCODE	ST.	PREZZO
04 11 39	8004537411393		4,15

**2 PENNELLI PASTICCERIA LEGNO 1+1,5"
EVA**

UV1	UV2	IMBALLO
1	12	1/24/240 PH



8 0 0 4 5 3 7 4 1 1 3 9 3



ART	BARCODE	ST.	PREZZO
04 67 01	4028574009768		6,05

**PENNELLO PASTICCERIA 4CM
SCHNEIDER**

UV1	UV2	IMBALLO
1	6	1/12 BK



4 0 2 8 5 7 4 0 0 9 7 6 8



ART	BARCODE	ST.	PREZZO
04 67 02	4028574009775		8,10

**PENNELLO PASTICCERIA 5CM
SCHNEIDER**

UV1	UV2	IMBALLO
1	6	1/12 BK



4 0 2 8 5 7 4 0 0 9 7 7 5



ART	BARCODE	ST.	PREZZO
04 67 03	4028574009782		8,40

**PENNELLO PASTICCERIA 6CM
SCHNEIDER**

UV1	UV2	IMBALLO
1	6	1/12 BK



4 0 2 8 5 7 4 0 0 9 7 8 2



ART	BARCODE	ST.	PREZZO
04 11 15	8004537411157		2,90

**PENNELLO PASTICCERIA 1,5" SILICONE
23CM EVA**

UV1	UV2	IMBALLO
1	12	1/12/192 CD



8 0 0 4 5 3 7 4 1 1 1 5 7



ART	BARCODE	ST.	PREZZO
04 11 44	8004537411447		5,80

**2 PENNELLI PASTICCERIA SILICONE
1+1,5" EVA**

UV1	UV2	IMBALLO
1	12	1/12/96 CD



8 0 0 4 5 3 7 4 1 1 4 4 7



ART	BARCODE	ST.	PREZZO
04 67 10	4028574300049		4,25

**PENNELLO PASTICCERIA
ANTIADERENTE 25 MM SCHNEIDER**

UV1	UV2	IMBALLO
1	6	1/1 BK



4 0 2 8 5 7 4 3 0 0 0 4 9



ART	BARCODE	ST.	PREZZO
04 67 11	4028574300056		5,25

**PENNELLO PASTICCERIA
ANTIADERENTE 35 MM SCHNEIDER**

UV1	UV2	IMBALLO
1	6	1/1 BK



4 0 2 8 5 7 4 3 0 0 0 5 6



ART	BARCODE	ST.	PREZZO
04 67 12	4028574309370		6,80

**PENNELLO PASTICCERIA
ANTIADERENTE 50 MM SCHNEIDER**

UV1	UV2	IMBALLO
1	6	1/1 BK



4 0 2 8 5 7 4 3 0 9 3 7 0



ART	BARCODE	ST.	PREZZO
04 67 13	4028574309387		7,10

**PENNELLO PASTICCERIA
ANTIADERENTE 60 MM SCHNEIDER**

UV1	UV2	IMBALLO
1	6	1/1 BK



4 0 2 8 5 7 4 3 0 9 3 8 7



ART	BARCODE	ST.	PREZZO
04 12 12	8004537412123		2,25

3 SPATOLE PASTICCERIA MANICO PLASTICA EVA

UV1	UV2	IMBALLO
1	12	1/12/216 BC



8 0 0 4 5 3 7 4 1 2 1 2 3



ART	BARCODE	ST.	PREZZO
04 11 13	8004537411133		3,40

SPATOLA PASTICCERIA MEDIUM SILICONE 26CM EVA

UV1	UV2	IMBALLO
1	12	1/12/192 CD



8 0 0 4 5 3 7 4 1 1 1 3 3



ART	BARCODE	ST.	PREZZO
04 11 14	8004537411140		4,20

SPATOLA PASTICCERIA LARGE SILICONE 28CM EVA

UV1	UV2	IMBALLO
1	12	1/12/144 CD



8 0 0 4 5 3 7 4 1 1 1 4 0



ART	BARCODE	ST.	PREZZO
04 66 60	4028574302371		9,40

SPATOLA PER PASTICCERIA NERO+SILICONE BIANCO 25 CM SCHNEIDER

UV1	UV2	IMBALLO
1	6	1/24 CD



4 0 2 8 5 7 4 3 0 2 3 7 1



ART	BARCODE	ST.	PREZZO
04 66 61	4028574302388		10,80

SPATOLA PER PASTICCERIA NERO+SILICONE BIANCO 35 CM SCHNEIDER

UV1	UV2	IMBALLO
1	6	1/12 CD



4 0 2 8 5 7 4 3 0 2 3 8 8



ART	BARCODE	ST.	PREZZO
04 66 62	4028574302395		12,20

SPATOLA PER PASTICCERIA NERO+SILICONE BIANCO 45 CM SCHNEIDER

UV1	UV2	IMBALLO
1	6	1/12 CD



4 0 2 8 5 7 4 3 0 2 3 9 5



ART	BARCODE	ST.	PREZZO
04 10 82	4004094300677		8,30

SPATOLA CON RIGHELLO PP/ACCIAIO INOSSIDABILE WESTMARK

UV1	UV2	IMBALLO
1	4	1/4/40 CD



4 0 0 4 0 9 4 3 0 0 6 7 7



ART	BARCODE	ST.	PREZZO
04 10 83	4004094300776		8,30

SPATOLA ANGOLARE + RIGHELLO PP/ACCIAIO INOSSIDABILE WESTMARK

UV1	UV2	IMBALLO
1	4	1/4/64 CD



4 0 0 4 0 9 4 3 0 0 7 7 6



ART	BARCODE	ST.	PREZZO
04 59 02	4044935077023	A	12,20

COLTELLO PASTICERE 43CM LAMA 29,5 CM ZENKER

UV1	UV2	IMBALLO
1	6	1/6 SC



4 0 4 4 9 3 5 0 7 7 0 2 3



ART	BARCODE	ST.	PREZZO
04 71 26	4018598504004		2,35

MINI SPATOLA PASTICCERIA PP 2,5 x 15 CM IN DISPLAY MAIBACK

UV1	UV2	IMBALLO
50	100	1/50 DB



4 0 1 8 5 9 8 5 0 4 0 0 4



ART	BARCODE	ST.	PREZZO
04 66 71	4028574009270		0,80

SPATOLA ROTONDA ABS 15X10CM SCHNEIDER

UV1	UV2	IMBALLO
1	10	1/100 BK



4 0 2 8 5 7 4 0 0 9 2 7 0



ART	BARCODE	ST.	PREZZO
04 12 05	8004537410006		0,60

SPATOLA PASTICCERIA PP 11,5 CM SCHNEIDER

UV1	UV2	IMBALLO
1	25	1/25/100 BK



8 0 0 4 5 3 7 4 1 0 0 0 6



ART	BARCODE	ST.	PREZZO
04 66 72	4028574009317	A	0,50

SPATOLA DENTELLATA ABS 11CM SCHNEIDER

UV1	UV2	IMBALLO
1	10	1/100 BK



4 0 2 8 5 7 4 0 0 9 3 1 7



ART	BARCODE	ST.	PREZZO
04 10 81	4004094308574		1,85

2 RASCHIETTI LISCIA+DENTATA PP WESTMARK

UV1	UV2	IMBALLO
1	10	1/10/60 CD



4 0 0 4 0 9 4 3 0 8 5 7 4



ART	BARCODE	ST.	PREZZO
04 66 91	4028574206013		6,30

TAGLIAPASTA ACCIAIO INOSSIDABILE / NERO 11 CM SCHNEIDER

UV1	UV2	IMBALLO
1	6	1/24 PG



4 0 2 8 5 7 4 2 0 6 0 1 3



ART	BARCODE	ST.	PREZZO
04 66 92	4028574206020		8,00

TAGLIAPASTA ACCIAIO INOSSIDABILE / NERO 13,5 CM SCHNEIDER

UV1	UV2	IMBALLO
1	6	1/24 PG



4 0 2 8 5 7 4 2 0 6 0 2 0



ART	BARCODE	ST.	PREZZO
04 66 96	4028574206006		6,30

TAGLIAPASTA FLESSIBILE ACCIAIO INOX/NERO 11CM SCHNEIDER

UV1	UV2	IMBALLO
1	6	1/24 PG



4 0 2 8 5 7 4 2 0 6 0 0 6



ART	BARCODE	ST.	PREZZO
04 66 95	4028574190701		6,30

TAGLIAPASTA FLESSIBILE ACCIAIO INOX/BIANCO 11CM SCHNEIDER

UV1	UV2	IMBALLO
1	6	1/24 PG



4 0 2 8 5 7 4 1 9 0 7 0 1



ART	BARCODE	ST.	PREZZO
04 12 03	8004537412031		8,30

SPATOLA TAGLIAPASTA ACCIAIO INOSSIDABILE EVA

UV1	UV2	IMBALLO
1	12	1/12/96 HB



8 0 0 4 5 3 7 4 1 2 0 3 1



ART	BARCODE	ST.	PREZZO
04 12 11	8004537412116		3,80

SPATOLA TAGLIAPASTA ACCIAIO INOSSIDABILE 15x11CM EVA

UV1	UV2	IMBALLO
1	12	1/12/36 PB



8 0 0 4 5 3 7 4 1 2 1 1 6

Grattugiare Macinare



ART	BARCODE	ST.	PREZZO
02 18 19	4004094971563		28,50

**GRATTUGIA A TAMBURRO MANDORLE
ABS/INOX WESTMARK**

UV1	UV2	IMBALLO
1	3	1/3/12 PB



4 0 0 4 0 9 4 9 7 1 5 6 3



ART	BARCODE	ST.	PREZZO
02 18 27	4004094977077		14,75

**MACINA NOCI PS/PE/ACCIAIO
INOSSIDABILE WESTMARK**

UV1	UV2	IMBALLO
1	3	1/3/18 SL



4 0 0 4 0 9 4 9 7 7 0 7 7



ART	BARCODE	ST.	PREZZO
02 18 21	4004094971761		43,25

**GRATTUGIA A TAMBURRO MANDORLE
'EXKLUSIV' ABS/INOX WESTMARK**

UV1	UV2	IMBALLO
1	3	1/3/18 PB



4 0 0 4 0 9 4 9 7 1 7 6 1



ART	BARCODE	ST.	PREZZO
02 18 22	4004094118364		36,50

**MACINA PAPAVERO/CEREALI 'POPPY'
WESTMARK**

UV1	UV2	IMBALLO
1	3	1/3/12 PB



4 0 0 4 0 9 4 1 1 8 3 6 4

Mescolare Sbattere Dosare



ART	BARCODE	ST.	PREZZO
04 16 33	4004094909078		5,30

SET 3 SASSOLE PP "TRIONALE"
50/100/150ML WESTMARK

UV1	UV2	IMBALLO
1	3	1/3/36 CD



4 0 0 4 0 9 4 9 0 9 0 7 8



ART	BARCODE	ST.	PREZZO
04 13 22	4004094914195		4,60

SASSOLA 'HYGIA' ALLUMINIO 21 CM 210
ML WESTMARK

UV1	UV2	IMBALLO
1	10	1/10/120 BK



4 0 0 4 0 9 4 9 1 4 1 9 5



ART	BARCODE	ST.	PREZZO
04 13 23	4004094916199		8,00

SASSOLA 'HYGIA' ALLUMINIO 26 CM 410
ML WESTMARK

UV1	UV2	IMBALLO
1	5	1/10/130 BK



4 0 0 4 0 9 4 9 1 6 1 9 9



ART	BARCODE	ST.	PREZZO
04 13 24	4004094917196		12,15

SASSOLA 'HYGIA' ALLUMINIO 31 CM 650
ML WESTMARK

UV1	UV2	IMBALLO
1	5	1/5/65 BK



4 0 0 4 0 9 4 9 1 7 1 9 6



ART	BARCODE	ST.	PREZZO
04 13 25	4004094918193		15,70

SASSOLA 'HYGIA' ALLUMINIO 35 CM 1100
ML WESTMARK

UV1	UV2	IMBALLO
1	5	1/5/30 BK



4 0 0 4 0 9 4 9 1 8 1 9 3



ART	BARCODE	ST.	PREZZO
04 16 35	4004094909191		2,60

SASSOLA POLIPROPILENE 110ML/100G
185X63X31MM WESTMARK

UV1	UV2	IMBALLO
1	12	1/12/288 BK



4 0 0 4 0 9 4 9 0 9 1 9 1



ART	BARCODE	ST.	PREZZO
04 16 36	4004094909399		3,40

SASSOLA POLIPROPILENE 230ML/250G
250X90X41MM WESTMARK

UV1	UV2	IMBALLO
1	12	1/12/96 BK



4 0 0 4 0 9 4 9 0 9 3 9 9

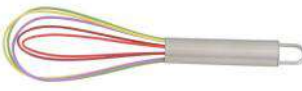

ART	BARCODE	ST.	PREZZO
04 03 40	8004537403404		4,45

FRUSTA SILICONE COLORATO/INOX
20CM EVA

UV1	UV2	IMBALLO
1	12	1/12/144 HT



8 0 0 4 5 3 7 4 0 3 4 0 4



ART	BARCODE	ST.	PREZZO
04 03 41	8004537403411		4,85

FRUSTA SILICONE COLORATO/INOX
25CM EVA

UV1	UV2	IMBALLO
1	12	1/12/144 HT



8 0 0 4 5 3 7 4 0 3 4 1 1



ART	BARCODE	ST.	PREZZO
04 03 43	8004537403435		4,50

FRUSTA SILICONE NERO/INOX 20CM EVA

UV1	UV2	IMBALLO
1	12	1/12/144 HT



8 0 0 4 5 3 7 4 0 3 4 3 5



ART	BARCODE	ST.	PREZZO
04 03 44	8004537403442		4,85

FRUSTA SILICONE NERO/INOX 25CM EVA

UV1	UV2	IMBALLO
1	12	1/12/144 HT



8 0 0 4 5 3 7 4 0 3 4 4 2



ART	BARCODE	ST.	PREZZO
04 03 09	8004537403091		2,75

FRUSTA ACCIAIO INOSSIDABILE 18/8
15CM EVA

UV1	UV2	IMBALLO
1	12	1/12/192 HT



8 0 0 4 5 3 7 4 0 3 0 9 1



ART	BARCODE	ST.	PREZZO
04 03 10	8004537403107		3,30

FRUSTA ACCIAIO INOSSIDABILE 18/8
20CM EVA

UV1	UV2	IMBALLO
1	12	1/12/144 HT



8 0 0 4 5 3 7 4 0 3 1 0 7



ART	BARCODE	ST.	PREZZO
04 03 11	8004537403114		3,65

FRUSTA ACCIAIO INOSSIDABILE 18/8
25CM EVA

UV1	UV2	IMBALLO
1	12	1/12/144 HT



8 0 0 4 5 3 7 4 0 3 1 1 4



ART	BARCODE	ST.	PREZZO
04 03 12	8004537403121		4,15

FRUSTA ACCIAIO INOSSIDABILE 18/8
30CM EVA

UV1	UV2	IMBALLO
1	12	1/12/96 HT



8 0 0 4 5 3 7 4 0 3 1 2 1



ART	BARCODE	ST.	PREZZO
04 03 26	8004537403268		7,10

FRUSTA CUCINA PROFESSIONALE INOX
35 CM 8 FILI EVA

UV1	UV2	IMBALLO
1	12	1/12/48 HT



8 0 0 4 5 3 7 4 0 3 2 6 8



ART	BARCODE	ST.	PREZZO
04 03 27	8004537403275		7,60

FRUSTA CUCINA PROFESSIONALE INOX
40 CM 8 FILI EVA

UV1	UV2	IMBALLO
1	12	1/12/48 AL



8 0 0 4 5 3 7 4 0 3 2 7 5



ART	BARCODE	ST.	PREZZO
04 03 16	8004537403169		5,20

FRUSTA PASTICCERIA PROFESSIONALE
INOX 25 CM 12 FILI EVA

UV1	UV2	IMBALLO
1	12	1/12/96 AL



8 0 0 4 5 3 7 4 0 3 1 6 9



ART	BARCODE	ST.	PREZZO
04 03 17	8004537403176		5,90

FRUSTA PASTICCERIA PROFESSIONALE
INOX 30 CM 12 FILI EVA

UV1	UV2	IMBALLO
1	12	1/12/60 HT



8 0 0 4 5 3 7 4 0 3 1 7 6



ART	BARCODE	ST.	PREZZO
04 03 18	8004537403183		6,50

FRUSTA PASTICCERIA PROFESSIONALE
INOX 35 CM 12 FILI EVA

UV1	UV2	IMBALLO
1	12	1/12/60 HT



8 0 0 4 5 3 7 4 0 3 1 8 3



ART	BARCODE	ST.	PREZZO
04 03 20	8004537403206	H	7,50

FRUSTA PASTICCERIA PROFESSIONALE
INOX 45 CM 12 FILI EVA

UV1	UV2	IMBALLO
1	12	1/12/60 AL



8 0 0 4 5 3 7 4 0 3 2 0 6



ART	BARCODE	ST.	PREZZO
04 03 28	8004537403282	H	7,60

FRUSTA CUCINA PROFESSIONALE INOX
45 CM 8 FILI EVA

UV1	UV2	IMBALLO
1	12	1/12/48 AL



8 0 0 4 5 3 7 4 0 3 2 8 2



ART	BARCODE	ST.	PREZZO
04 03 29	8004537403299	H	8,00

FRUSTA CUCINA PROFESSIONALE INOX
50 CM 8 FILI EVA

UV1	UV2	IMBALLO
1	12	1/12/48 AL



8 0 0 4 5 3 7 4 0 3 2 9 9



ART	BARCODE	ST.	PREZZO
04 03 30	8004537403305	H	8,90

FRUSTA CUCINA PROFESSIONALE INOX
55 CM 8 FILI EVA

UV1	UV2	IMBALLO
1	12	1/12/48 AL



8 0 0 4 5 3 7 4 0 3 3 0 5



ART	BARCODE	ST.	PREZZO
04 03 31*	8004537403312	H	9,80

FRUSTA CUCINA PROFESSIONALE INOX
60 CM 8 FILI EVA

UV1	UV2	IMBALLO
1	12	1/12/48 AL



8 0 0 4 5 3 7 4 0 3 3 1 2



ART	BARCODE	ST.	PREZZO
04 03 03	7611264502099		7,90

FRUSTA A PRESSIONE MANICO SOFT
'RAPIDO' INOX/TPE 30.5CM MOHA

UV1	UV2	IMBALLO
1	6	1/12/24 CD



7 6 1 1 2 6 4 5 0 2 0 9 9



ART	BARCODE	ST.	PREZZO
04 03 34	8004537403343		9,05

FRULLINO STANDARD ACCIAIO
INOSSIDABILE EVA

UV1	UV2	IMBALLO
1	12	1/12/72 CD



8 0 0 4 5 3 7 4 0 3 3 4 3



ART	BARCODE	ST.	PREZZO
04 03 36	8004537403367		14,90

FRULLINO CROMATO EVA

UV1	UV2	IMBALLO
1	12	1/12/48 CD



8 0 0 4 5 3 7 4 0 3 3 6 7



ART	BARCODE	ST.	PREZZO
04 14 01	4005643821162		3,50

BACINELLA IN ACCIAIO INOSSIDABILE
Ø16CM GSW

UV1	UV2	IMBALLO
1	12	1/4/12 BK



4 0 0 5 6 4 3 8 2 1 1 6 2



ART	BARCODE	ST.	PREZZO
04 14 02	4005643821209		5,50

BACINELLA IN ACCIAIO INOSSIDABILE
Ø20CM GSW

UV1	UV2	IMBALLO
1	12	1/4/12 BK



4 0 0 5 6 4 3 8 2 1 2 0 9



ART	BARCODE	ST.	PREZZO
04 14 03	4005643821247		7,80

BACINELLA IN ACCIAIO INOSSIDABILE
Ø24CM GSW

UV1	UV2	IMBALLO
1	12	1/4/12 BK



4 0 0 5 6 4 3 8 2 1 2 4 7



ART	BARCODE	ST.	PREZZO
04 14 04	4005643821285		11,80

BACINELLA IN ACCIAIO INOSSIDABILE
Ø28CM GSW

UV1	UV2	IMBALLO
1	12	1/2/12 BK



4 0 0 5 6 4 3 8 2 1 2 8 5



ART	BARCODE	ST.	PREZZO
04 14 05	4005643821346		18,50

BACINELLA IN ACCIAIO INOSSIDABILE
Ø34CM GSW

UV1	UV2	IMBALLO
1	12	1/12 BK



4 0 0 5 6 4 3 8 2 1 3 4 6



ART	BARCODE	ST.	PREZZO
04 14 06	4005643821360		22,50

BACINELLA IN ACCIAIO INOSSIDABILE
Ø36CM GSW

UV1	UV2	IMBALLO
1	12	1/12 BK



4 0 0 5 6 4 3 8 2 1 3 6 0



ART	BARCODE	ST.	PREZZO
04 14 07	4005643821407		26,50

BACINELLA IN ACCIAIO INOSSIDABILE
Ø40CM GSW

UV1	UV2	IMBALLO
1	12	1/12 BK



4 0 0 5 6 4 3 8 2 1 4 0 7



ART	BARCODE	ST.	PREZZO
04 14 22	4010411233207		8,80

BACINELLA 'GASTRO' IN ACCIAIO
INOSSIDABILE Ø20CM-1,0L WEIS

UV1	UV2	IMBALLO
1	12	1/12/48 BK



4 0 1 0 4 1 1 2 3 3 2 0 7



ART	BARCODE	ST.	PREZZO
04 14 23	4010411233245		11,50

BACINELLA 'GASTRO' IN ACCIAIO
INOSSIDABILE Ø24CM-2,5L WEIS

UV1	UV2	IMBALLO
1	12	1/12/24 BK



4 0 1 0 4 1 1 2 3 3 2 4 5



ART	BARCODE	ST.	PREZZO
04 14 24	4010411233283		15,90

BACINELLA 'GASTRO' IN ACCIAIO
INOSSIDABILE Ø28CM-4,0L WEIS

UV1	UV2	IMBALLO
1	12	1/12/24 BK



4 0 1 0 4 1 1 2 3 3 2 8 3



ART	BARCODE	ST.	PREZZO
04 14 17	9002655011746		34,50

BASTARDELLA ACCIAIO INOSSIDABILE
22CM KELOMAT

UV1	UV2	IMBALLO
1	2	1/6 HT



9 0 0 2 6 5 5 0 1 1 7 4 6



ART	BARCODE	ST.	PREZZO
04 14 18	9002655011814		14,90

BASE PER BASTARDELLA ACCIAIO
INOSSIDABILE 22CM KELOMAT

UV1	UV2	IMBALLO
1	2	1/20 HT



9 0 0 2 6 5 5 0 1 1 8 1 4



ART	BARCODE	ST.	PREZZO
04 12 08	4013291441731		2,30

BACINELLA+BORDO PP 1,5L Ø18CM

UV1	UV2	IMBALLO
1	12	1/12 BK



4 0 1 3 2 9 1 4 4 1 7 3 1



ART	BARCODE	ST.	PREZZO
04 12 09	4013291441748		2,95

BACINELLA+BORDO PP 2,5L Ø23CM

UV1	UV2	IMBALLO
1	6	1/6 BK



4 0 1 3 2 9 1 4 4 1 7 4 8



ART	BARCODE	ST.	PREZZO
04 12 10	4013291441755		3,70

BACINELLA+BORDO PP 3,5L Ø27CM

UV1	UV2	IMBALLO
1	6	1/6 BK



4 0 1 3 2 9 1 4 4 1 7 5 5



ART	BARCODE	ST.	PREZZO
04 67 40	4028574034234		4,40

BACINELLA PASTICCERIA PP Ø 20 CM -
1.0 L SCHNEIDER

UV1	UV2	IMBALLO
1	6	1/36 BK



4 0 2 8 5 7 4 0 3 4 2 3 4



ART	BARCODE	ST.	PREZZO
04 67 41	4028574034241		6,00

BACINELLA PASTICCERIA PP Ø 24 CM -
2.5 L SCHNEIDER

UV1	UV2	IMBALLO
1	6	1/36 BK



4 0 2 8 5 7 4 0 3 4 2 4 1



ART	BARCODE	ST.	PREZZO
04 67 42	4028574034258		7,00

BACINELLA PASTICCERIA PP Ø 28 CM -
4.5 L SCHNEIDER

UV1	UV2	IMBALLO
1	6	1/24 BK



4 0 2 8 5 7 4 0 3 4 2 5 8



ART	BARCODE	ST.	PREZZO
04 67 43	4028574034265		9,80

BACINELLA PASTICCERIA PP Ø 32 CM -
6.0 L SCHNEIDER

UV1	UV2	IMBALLO
1	6	1/24 BK



4 0 2 8 5 7 4 0 3 4 2 6 5



ART	BARCODE	ST.	PREZZO
04 67 44	4028574034272		11,40

BACINELLA PASTICCERIA PP Ø 36 CM -
9.0 L SCHNEIDER

UV1	UV2	IMBALLO
1	6	1/12 BK



4 0 2 8 5 7 4 0 3 4 2 7 2



ART	BARCODE	ST.	PREZZO
04 67 45	4028574034289		15,50

BACINELLA PASTICCERIA PP Ø 40 CM - 13.0 L SCHNEIDER

UV1	UV2	IMBALLO
1	6	1/12 BK



4 0 2 8 5 7 4 0 3 4 2 8 9



ART	BARCODE	ST.	PREZZO
04 17 85	7610859221681		10,00

CIOTOLA PER LIEVITAZIONE 'RONDO' PP 6L Ø32X13,5 CM ROTHO

UV1	UV2	IMBALLO
1	3	1/3 AL



7 6 1 0 8 5 9 2 2 1 6 8 1



ART	BARCODE	ST.	PREZZO
04 16 94	4004094315374		7,20

BACINELLA PER IMPASTARE +COPERCIO ROSSO PP/PE 2,5L WESTMARK

UV1	UV2	IMBALLO
1	6	1/6 AL



4 0 0 4 0 9 4 3 1 5 3 7 4



ART	BARCODE	ST.	PREZZO
04 16 97	4004094315572		9,25

BACINELLA PER IMPASTARE +COPERCIO ROSSO PP/PE 3,5L WESTMARK

UV1	UV2	IMBALLO
1	6	1/6 AL



4 0 0 4 0 9 4 3 1 5 5 7 2



ART	BARCODE	ST.	PREZZO
04 14 41	4004094320477		18,25

CESTINO LIEVITAZIONE OVALE VIMINI 27X14X7 CM WESTMARK

UV1	UV2	IMBALLO
1	3	1/3/18 SL



4 0 0 4 0 9 4 3 2 0 4 7 7



ART	BARCODE	ST.	PREZZO
04 14 42	4004094320279		22,00

CESTINO LIEVITAZIONE OVALE VIMINI 39X15X7 CM WESTMARK

UV1	UV2	IMBALLO
1	3	1/3/18 SL



4 0 0 4 0 9 4 3 2 0 2 7 9



ART	BARCODE	ST.	PREZZO
04 14 43	4004094320873		15,80

CESTINO LIEVITAZIONE ROTONDO VIMINI Ø17X8 CM WESTMARK

UV1	UV2	IMBALLO
1	3	1/3/24 SL



4 0 0 4 0 9 4 3 2 0 8 7 3



ART	BARCODE	ST.	PREZZO
04 14 45	4004094320774		19,50

CESTINO LIEVITAZIONE ROTONDO VIMINI Ø20X8 CM WESTMARK

UV1	UV2	IMBALLO
1	3	1/3/18 SL



4 0 0 4 0 9 4 3 2 0 7 7 4



ART	BARCODE	ST.	PREZZO
04 14 44	4004094320675		21,00

CESTINO LIEVITAZIONE ROTONDO VIMINI Ø24X8 CM WESTMARK

UV1	UV2	IMBALLO
1	3	1/3/24 SL



4 0 0 4 0 9 4 3 2 0 6 7 5



ART	BARCODE	ST.	PREZZO
04 11 36	8004537411362		17,90

DISPENSER PER IMPASTO ACCIAIO INOSSIDABILE EVA

UV1	UV2	IMBALLO
1	6	1/12 PB



8 0 0 4 5 3 7 4 1 1 3 6 2



ART	BARCODE	ST.	PREZZO
04 11 41	8004537411416	A	16,90

COLINO DOSATORE PASTICCERIA ACCIAIO INOSSIDABILE Ø 13CM EVA

UV1	UV2	IMBALLO
1	6	1/6 PB



8 0 0 4 5 3 7 4 1 1 4 1 6



ART	BARCODE	ST.	PREZZO
04 11 40	8004537411409		41,80

IMBUTO COLATORE + 3 BOCCHETTE ACCIAIO INOX Ø 17,5CM EVA

UV1	UV2	IMBALLO
1	6	1/6 PB



8 0 0 4 5 3 7 4 1 1 4 0 9



ART	BARCODE	ST.	PREZZO
04 16 02	4009808224010		1,95

MISURINO GRADUATO SAN 150 CCM
BUCHSTEINER

UV1	UV2	IMBALLO
1	18	1/18/162 BK



4 0 0 9 8 0 8 2 2 4 0 1 0



ART	BARCODE	ST.	PREZZO
04 16 03	4009808224119		2,90

MISURINO GRADUATO SAN 350 CCM
BUCHSTEINER

UV1	UV2	IMBALLO
1	6	1/6/36 BK



4 0 0 9 8 0 8 2 2 4 1 1 9



ART	BARCODE	ST.	PREZZO
04 16 25	8593419327728		9,70

MISURA GRADUATA VETRO 1L SIMAX
BOHEMIA

UV1	UV2	IMBALLO
1	6	1/6 PB



8 5 9 3 4 1 9 3 2 7 7 2 8



ART	BARCODE	ST.	PREZZO
04 16 13	4009808330261		2,30

MISURA GRADUATA SAN 0,5L
BUCHSTEINER

UV1	UV2	IMBALLO
1	6	1/36 BK



4 0 0 9 8 0 8 3 3 0 2 6 1



ART	BARCODE	ST.	PREZZO
04 16 14	4009808330360		4,10

MISURA GRADUATA SAN 1,0L
BUCHSTEINER

UV1	UV2	IMBALLO
1	5	1/5/40 BK



4 0 0 9 8 0 8 3 3 0 3 6 0



ART	BARCODE	ST.	PREZZO
04 16 05	4009808495014		5,85

MISURA GRADUATA SAN 1,5 L
BUCHSTEINER

UV1	UV2	IMBALLO
1	5	1/10 BK



4 0 0 9 8 0 8 4 9 5 0 1 4



ART	BARCODE	ST.	PREZZO
04 16 07	40040943306877		6,35

CARAFFA GRADUATA 'GERDA' SAN 1 L
WESTMARK

UV1	UV2	IMBALLO
1	6	1/36 BK



4 0 0 4 0 9 4 3 3 0 6 8 7 7



ART	BARCODE	ST.	PREZZO
04 14 09	4004094310577		9,50

BRICCO PER IMPASTARE GRADUATO
'HELENA' PP 1,4 L WESTMARK

UV1	UV2	IMBALLO
1	4	1/8 SL



4 0 0 4 0 9 4 3 1 0 5 7 7



ART	BARCODE	ST.	PREZZO
04 16 16	4021322907019		6,70

MISURA GRADUATA ACRILICO 1,5L
KAYSER

UV1	UV2	IMBALLO
1	5	1/5 BK



4 0 2 1 3 2 2 9 0 7 0 1 9



ART	BARCODE	ST.	PREZZO
04 16 09	4009808337413		4,20

MISURA GRADUATA PROFESSIONALE PP
2,0L BUCHSTEINER

UV1	UV2	IMBALLO
1	5	1/60 BK



4 0 0 9 8 0 8 3 3 7 4 1 3



ART	BARCODE	ST.	PREZZO
04 16 10	4009808337512		4,75

MISURA GRADUATA PROFESSIONALE PP
3,0L BUCHSTEINER

UV1	UV2	IMBALLO
1	5	1/45 BK



4 0 0 9 8 0 8 3 3 7 5 1 2



ART	BARCODE	ST.	PREZZO
04 67 30	4028574011433		3,25

MISURA GRADUATA PP 0,25L
SCHNEIDER

UV1	UV2	IMBALLO
1	5	1/25 BK



4 0 2 8 5 7 4 0 1 1 4 3 3



ART	BARCODE	ST.	PREZZO
04 67 31	4028574011440		3,40

MISURA GRADUATA PP 0,5L SCHNEIDER

UV1	UV2	IMBALLO
1	8	1/16 BK



4 0 2 8 5 7 4 0 1 1 4 4 0



ART	BARCODE	ST.	PREZZO
04 67 32	4028574011457		4,80

MISURA GRADUATA PP 1L SCHNEIDER

UV1	UV2	IMBALLO
1	6	1/12 BK



4 0 2 8 5 7 4 0 1 1 4 5 7



ART	BARCODE	ST.	PREZZO
04 67 33	4028574011464		8,20

MISURA GRADUATA PP 2L SCHNEIDER

UV1	UV2	IMBALLO
1	6	1/12 BK



4 0 2 8 5 7 4 0 1 1 4 6 4



ART	BARCODE	ST.	PREZZO
04 67 34	4028574011471		10,75

MISURA GRADUATA PP 3L SCHNEIDER

UV1	UV2	IMBALLO
1	5	1/10 BK



4 0 2 8 5 7 4 0 1 1 4 7 1



ART	BARCODE	ST.	PREZZO
04 67 35	4028574011488		13,30

MISURA GRADUATA PP 5L SCHNEIDER

UV1	UV2	IMBALLO
1	5	1/5 BK



4 0 2 8 5 7 4 0 1 1 4 8 8



ART	BARCODE	ST.	PREZZO
04 16 21*	8004537416213	H	9,90

MISURA GRADUATA ACCIAIO
INOSSIDABILE 0,5 LITRI EVA

UV1	UV2	IMBALLO
1	6	1/6/24 AL



8 0 0 4 5 3 7 4 1 6 2 1 3



ART	BARCODE	ST.	PREZZO
04 16 22*	8004537416220	H	13,50

MISURA GRADUATA ACCIAIO
INOSSIDABILE 1,0 LITRI EVA

UV1	UV2	IMBALLO
1	6	1/6/24 AL



8 0 0 4 5 3 7 4 1 6 2 2 0



ART	BARCODE	ST.	PREZZO
04 16 17	4004094305870		5,40

6 MISURINI A CUCCHIAIO
"MATROSKHA" PP WESTMARK

UV1	UV2	IMBALLO
1	3	1/3/36 CD



4 0 0 4 0 9 4 3 0 5 8 7 0



ART	BARCODE	ST.	PREZZO
04 38 86*	8004537438864	H	7,90

TERMOMETRO ZUCCHERO ACCIAIO
INOSSIDABILE +20/+200C° EVA

UV1	UV2	IMBALLO
1	6	1/6/72 SC



8 0 0 4 5 3 7 4 3 8 8 6 4



ART	BARCODE	ST.	PREZZO
04 38 91*	8004537438918	H	11,50

TERMOMETRO A SPATOLA DIGITALE
-50°/+300° EVA

UV1	UV2	IMBALLO
1	8	1/10/40 SC



8 0 0 4 5 3 7 4 3 8 9 1 8

Decorare Guarnire Porzionare



ART	BARCODE	ST.	PREZZO
02 12 20*	9002539011169		4,60

6 CAPSULE PANNA KAYSER

UV1	UV2	IMBALLO
1	10	1/40 BC



9 0 0 2 5 3 9 0 1 1 1 6 9



ART	BARCODE	ST.	PREZZO
02 12 02*	9002539011114		6,90

10 CAPSULE PANNA KAYSER

UV1	UV2	IMBALLO
1	30	1/30 PB



9 0 0 2 5 3 9 0 1 1 1 1 4



ART	BARCODE	ST.	PREZZO
02 12 01*	9002539011510		34,20

50 CAPSULE PANNA KAYSER

UV1	UV2	IMBALLO
1	6	1/6 PB



9 0 0 2 5 3 9 0 1 1 5 1 0



ART	BARCODE	ST.	PREZZO
02 12 09*	9002539049254		57,50

SIFONE PANNA "STYLE" ACCIAIO
INOSSIDABILE 0.25L KAYSER

UV1	UV2	IMBALLO
1	2	1/6 PB



9 0 0 2 5 3 9 0 4 9 2 5 4



ART	BARCODE	ST.	PREZZO
02 12 10*	9002539049506		61,50

SIFONE PANNA "STYLE" ACCIAIO
INOSSIDABILE 0.5L KAYSER

UV1	UV2	IMBALLO
1	2	1/6 PB



9 0 0 2 5 3 9 0 4 9 5 0 6



ART	BARCODE	ST.	PREZZO
02 12 13	9002539049551		45,00

SIFONE PANNA STYLE EDITION WHITE
ALLUMINIO 0,5L KAYSER

UV1	UV2	IMBALLO
1	2	1/6 PB



9 0 0 2 5 3 9 0 4 9 5 5 1



ART	BARCODE	ST.	PREZZO
02 12 06*	9002539048509	A	59,50

SIFONE PANNA WHIPCREAMER ACCIAIO
INOSSIDABILE 0,5L KAYSER

UV1	UV2	IMBALLO
1	3	1/6 PB



9 0 0 2 5 3 9 0 4 8 5 0 9



ART	BARCODE	ST.	PREZZO
02 12 08*	9002539045508	A	93,50

SIFONE PANNA SYMPHONIE 0,5L
KAYSER

UV1	UV2	IMBALLO
1	2	1/6 PB



9 0 0 2 5 3 9 0 4 5 5 0 8



ART	BARCODE	ST.	PREZZO
02 12 04*	9002539040510		117,50

SIFONE PANNA PROFI INOXCREAMER
0,5L KAYSER

UV1	UV2	IMBALLO
1	2	1/6 PB



9 0 0 2 5 3 9 0 4 0 5 1 0



ART	BARCODE	ST.	PREZZO
02 12 05*	9002539041012		125,50

SIFONE PANNA PROFI INOXCREAMER
1,0L KAYSER

UV1	UV2	IMBALLO
1	2	1/6 PB



9 0 0 2 5 3 9 0 4 1 0 1 2



ART	BARCODE	ST.	PREZZO
04 09 04	8004537409048		5,25

PORZIONATORE ACCIAIO INOSSIDABILE
Ø7,5CM H4CM EVA

UV1	UV2	IMBALLO
1	10	1/10/50 PH



8 0 0 4 5 3 7 4 0 9 0 4 8



ART	BARCODE	ST.	PREZZO
04 09 05	8004537409055		5,80

PORZIONATORE ACCIAIO INOSSIDABILE
Ø8,5CM H4,5CM EVA

UV1	UV2	IMBALLO
1	10	1/10/50 PH



8 0 0 4 5 3 7 4 0 9 0 5 5



ART	BARCODE	ST.	PREZZO
04 09 06	8004537409062		6,30

PORZIONATORE ACCIAIO INOSSIDABILE Ø9,5CM H5CM EVA

UV1	UV2	IMBALLO
1	10	1/10/50 PH



8 0 0 4 5 3 7 4 0 9 0 6 2



ART	BARCODE	ST.	PREZZO
04 09 18	8004537409185	H	6,00

PORZIONATORE ACCIAIO INOSSIDABILE 9X9CM H5CM EVA

UV1	UV2	IMBALLO
1	10	1/10/50 PH



8 0 0 4 5 3 7 4 0 9 1 8 5



ART	BARCODE	ST.	PREZZO
04 12 54	8004537412543		9,40

3 PORZIONATORI ROTONDI ACCIAIO INOSSIDABILE Ø6-8-10CM EVA

UV1	UV2	IMBALLO
1	12	1/6/72 PV



8 0 0 4 5 3 7 4 1 2 5 4 3



ART	BARCODE	ST.	PREZZO
04 11 54	7611264517093		8,70

PORZIONATORE GELATO ALLUMINIO 'GELATI' Ø42MM MOHA

UV1	UV2	IMBALLO
1	6	1/6/48 HT



7 6 1 1 2 6 4 5 1 7 0 9 3



ART	BARCODE	ST.	PREZZO
04 11 55	8004537411553		16,60

PORZIONATORE GELATO ACCIAIO INOSSIDABILE 18/8 1/24 Ø50MM EVA

UV1	UV2	IMBALLO
1	6	1/6/96 CD



8 0 0 4 5 3 7 4 1 1 5 5 3



ART	BARCODE	ST.	PREZZO
04 11 53	7611264517116		14,60

PORZIONATORE GELATO ALLUMINIO 'ICE COOL' Ø50MM MOHA

UV1	UV2	IMBALLO
1	12	1/12/48 CD



7 6 1 1 2 6 4 5 1 7 1 1 6



ART	BARCODE	ST.	PREZZO
04 11 57	8004537411577		3,95

PORZIONATORE GELATO ALLUMINIO GRIGIO 18CM EVA

UV1	UV2	IMBALLO
1	6	1/6/36 CD



8 0 0 4 5 3 7 4 1 1 5 7 7



ART	BARCODE	ST.	PREZZO
04 12 21	8004537412215		16,30

IMBUTO PER FRITTELLE ACCIAIO INOSSIDABILE 18/8 EVA

UV1	UV2	IMBALLO
1	12	1/12/72 CD



8 0 0 4 5 3 7 4 1 2 2 1 5



ART	BARCODE	ST.	PREZZO
04 12 16	8004537412161		7,90

STAMPO FRITTELLE EVA

UV1	UV2	IMBALLO
1	12	1/12/72 BC



8 0 0 4 5 3 7 4 1 2 1 6 1



ART	BARCODE	ST.	PREZZO
04 11 18	8004537411188		35,80

CANNELLO PER CAMELLARE PROFI EVA

UV1	UV2	IMBALLO
1	10	1/10/20 DC



8 0 0 4 5 3 7 4 1 1 1 8 8



ART	BARCODE	ST.	PREZZO
04 11 19	8004537411195		29,90

CANNELLO PER CAMELLARE BASIC EVA

UV1	UV2	IMBALLO
1	10	1/10/20 DC



8 0 0 4 5 3 7 4 1 1 1 9 5



ART	BARCODE	ST.	PREZZO
04 17 69	4008256033007		4,30

GRATICOLA TORTE CROMATA 30CM

UV1	UV2	IMBALLO
1	12	1/6/48 CD



4 0 0 8 2 5 6 0 3 3 0 0 7



ART	BARCODE	ST.	PREZZO
04 10 92	4004094314377		4,20

**RAFFEDDATORTE+SEGNAPORZIONI
BIANCO PS Ø 32 CM WESTMARK**

UV1	UV2	IMBALLO
1	10	1/10/20 SL



4 0 0 4 0 9 4 3 1 4 3 7 7



ART	BARCODE	ST.	PREZZO
04 74 64	8004537474640		16,30

**ANELLO TAGLIATORTE ACCIAIO
INOSSIDABILE 26-28CM EVA**

UV1	UV2	IMBALLO
1	5	1/5 PB



8 0 0 4 5 3 7 4 7 4 6 4 0



ART	BARCODE	ST.	PREZZO
04 10 34	8004537410341		3,70

**TAGLIATORTE ACCIAIO INOSSIDABILE
28CM EVA**

UV1	UV2	IMBALLO
1	12	1/12/72 CD



8 0 0 4 5 3 7 4 1 0 3 4 1



ART	BARCODE	ST.	PREZZO
04 13 50	4004094712074		7,75

**TAGLIATORTE SIMPLEX ACCIAIO
INOSSIDABILE 29 CM WESTMARK**

UV1	UV2	IMBALLO
1	5	1/5/50 CD



4 0 0 4 0 9 4 7 1 2 0 7 4



ART	BARCODE	ST.	PREZZO
04 10 35	4003244062311		19,90

**TAGLIATORTE ACCIAIO INOSSIDABILE
40CM**

UV1	UV2	IMBALLO
1	2	1/15 WB



4 0 0 3 2 4 4 0 6 2 3 1 1



ART	BARCODE	ST.	PREZZO
04 11 27	4004094314278		11,60

**SPATOLA SFILATORTE/PIZZE ACCIAIO
INOX 31CM WESTMARK**

UV1	UV2	IMBALLO
1	3	1/3/24 CL



4 0 0 4 0 9 4 3 1 4 2 7 8



ART	BARCODE	ST.	PREZZO
04 71 37*	4018598498082	H	4,70

**SEGNAPROZIONI RETTANGOLARE 6/8
PORZIONI 25X19CM MAIBACK**

UV1	UV2	IMBALLO
1	5	1/5 CD



4 0 1 8 5 9 8 4 9 8 0 8 2



ART	BARCODE	ST.	PREZZO
04 71 36	4018598498068	A	5,90

**SEGNAPROZIONI ROTONDO 12/16
PORZIONI Ø27,5CM MAIBACK**

UV1	UV2	IMBALLO
1	5	1/5/70 CD



4 0 1 8 5 9 8 4 9 8 0 6 8



ART	BARCODE	ST.	PREZZO
04 71 35	4018598547018		16,90

**2 PEZZI STAMPA DECORA CROSTATE
ROTONDO Ø30CM MAIBACK**

UV1	UV2	IMBALLO
1	5	1/1 SP



4 0 1 8 5 9 8 5 4 7 0 1 8



ART	BARCODE	ST.	PREZZO
04 70 65	4018598552135		18,90

**ALZATA TORTE GIREVOLE+PIEDE
PLASTICA BIANC.Ø27,5X7CM MAIBACK**

UV1	UV2	IMBALLO
1	8	1/16 PB



4 0 1 8 5 9 8 5 5 2 1 3 5



ART	BARCODE	ST.	PREZZO
04 50 62	4009085096409	A	21,50

**PIATTO PORTA-TORTE ROTONDO
BIANCO MELAMINA Ø 32 CM WACA**

UV1	UV2	IMBALLO
1	2	1/2 BK



4 0 0 9 0 8 5 0 9 6 4 0 9



ART	BARCODE	ST.	PREZZO
04 50 63	4009085096805	A	27,50

**ALZATA PORTA-TORTE GIREVOLE
BIANCA MELAMINA Ø 32 CM WACA**

UV1	UV2	IMBALLO
1	2	1/1 BK



4 0 0 9 0 8 5 0 9 6 8 0 5



ART	BARCODE	ST.	PREZZO
04 12 56	8004537412567		9,40

MACCHINA BISCOTTI ACCIAIO
INOSSIDABILE / ALLUMINIO EVA

UV1	UV2	IMBALLO
1	6	1/24 PB



8 0 0 4 5 3 7 4 1 2 5 6 7



ART	BARCODE	ST.	PREZZO
04 12 57	8004537412574		13,60

MACCHINA BISCOTTI ACCIAIO
INOSSIDABILE EVA

UV1	UV2	IMBALLO
1	6	1/24 PB



8 0 0 4 5 3 7 4 1 2 5 7 4



ART	BARCODE	ST.	PREZZO
04 68 10	4028574263139		52,90

SPRUZZATORE ARIA COMPRESSA 1,8 L
SCHNEIDER

UV1	UV2	IMBALLO
1	2	1/1 PG



4 0 2 8 5 7 4 2 6 3 1 3 9



ART	BARCODE	ST.	PREZZO
04 11 34	4004094311666		9,80

SIRINGA PER DOLCI + 5 BOCCHETTE
SAN/PP 180 ML WESTMARK

UV1	UV2	IMBALLO
1	5	1/15 HB



4 0 0 4 0 9 4 3 1 1 6 6 6



ART	BARCODE	ST.	PREZZO
04 11 28	8004537411287		2,85

SIRINGA DOLCI + 5 BOCCHETTE
PLASTICA EVA

UV1	UV2	IMBALLO
1	12	1/12/72 BC



8 0 0 4 5 3 7 4 1 1 2 8 7



ART	BARCODE	ST.	PREZZO
04 11 35	4004094323867		9,80

SIRINGA DOPPIOUSO + 6 BOCCHETTE
PS/PP/SAN 280 ML WESTMARK

UV1	UV2	IMBALLO
1	3	1/3/21 HB



4 0 0 4 0 9 4 3 2 3 8 6 7



ART	BARCODE	ST.	PREZZO
04 11 01	8004537411010		3,40

SACCAPOCCHES N. 1 TELA PLASTIFICATA
28CM EVA

UV1	UV2	IMBALLO
1	10	1/10/500 PG



8 0 0 4 5 3 7 4 1 1 0 1 0



ART	BARCODE	ST.	PREZZO
04 11 02	8004537411027		3,95

SACCAPOCCHES N. 2 TELA PLASTIFICATA
34CM EVA

UV1	UV2	IMBALLO
1	10	1/10/500 PG



8 0 0 4 5 3 7 4 1 1 0 2 7



ART	BARCODE	ST.	PREZZO
04 11 03	8004537411034		4,95

SACCAPOCCHES N. 3 TELA PLASTIFICATA
40CM EVA

UV1	UV2	IMBALLO
1	10	1/10/500 PG



8 0 0 4 5 3 7 4 1 1 0 3 4



ART	BARCODE	ST.	PREZZO
04 11 04	8004537411041		5,70

SACCAPOCCHES N. 4 TELA PLASTIFICATA
46CM EVA

UV1	UV2	IMBALLO
1	10	1/10/500 PG



8 0 0 4 5 3 7 4 1 1 0 4 1



ART	BARCODE	ST.	PREZZO
04 11 05	8004537411058		6,40

SACCAPOCCHES N. 5 TELA PLASTIFICATA
50CM EVA

UV1	UV2	IMBALLO
1	10	1/10/500 PG



8 0 0 4 5 3 7 4 1 1 0 5 8



ART	BARCODE	ST.	PREZZO
04 11 06	8004537411065		8,40

SACCAPOCCHES N. 7 TELA PLASTIFICATA
60CM EVA

UV1	UV2	IMBALLO
1	10	1/10/500 PG



8 0 0 4 5 3 7 4 1 1 0 6 5



ART	BARCODE	ST.	PREZZO
04 11 07	8004537411072		10,70

SACCAPOCHE N. 9 TELA PLASTIFICATA 70CM EVA

UV1	UV2	IMBALLO
1	10	1/10/100 PG



8 0 0 4 5 3 7 4 1 1 0 7 2



ART	BARCODE	ST.	PREZZO
04 11 16	4004094308666		6,90

TASCA DA PASTICCIERE + 5 BOCCHETTE PP/LINO 28 CM WESTMARK

UV1	UV2	IMBALLO
1	5	1/5/25 HB



4 0 0 4 0 9 4 3 0 8 6 6 6



ART	BARCODE	ST.	PREZZO
04 11 29	8004537411294		1,80

SACCAPOCHE + 5 BOCCHETTE PLASTICA 30CM EVA

UV1	UV2	IMBALLO
1	12	1/12/192 BC



8 0 0 4 5 3 7 4 1 1 2 9 4



ART	BARCODE	ST.	PREZZO
04 11 30	8004537411300		3,25

SACCAPOCHE + 6 BOCCHETTE PLASTICA 31CM EVA

UV1	UV2	IMBALLO
1	10	1/100/1000 PH



8 0 0 4 5 3 7 4 1 1 3 0 0



ART	BARCODE	ST.	PREZZO
04 11 32	4028574030434		33,50

100 SACCAPOCHE USA&GETTA PE 50X28 CM SCHNEIDER

UV1	UV2	IMBALLO
1	6	1/12 LB



4 0 2 8 5 7 4 0 3 0 4 3 4



ART	BARCODE	ST.	PREZZO
04 65 27	4028574351997		6,90

10 SACCAPOCHE MONOUSO+4 BOCCHETTE SCHNEIDER

UV1	UV2	IMBALLO
1	20	1/20/120 HB



4 0 2 8 5 7 4 3 5 1 9 9 7



ART	BARCODE	ST.	PREZZO
04 70 60	4018598247222		3,50

10 SACCAPOCHE MONOUSO 35 CM MAIBACK

UV1	UV2	IMBALLO
1	10	1/1 HB



4 0 1 8 5 9 8 2 4 7 2 2 2



ART	BARCODE	ST.	PREZZO
04 65 01	4028574255004		7,70

SACCAPOCHE 'MASTERFLEX' NR. 2 SCHNEIDER

UV1	UV2	IMBALLO
1	10	1/1 PG



4 0 2 8 5 7 4 2 5 5 0 0 4



ART	BARCODE	ST.	PREZZO
04 65 02	4028574255011		8,90

SACCAPOCHE 'MASTERFLEX' NR. 3 SCHNEIDER

UV1	UV2	IMBALLO
1	10	1/1 PG



4 0 2 8 5 7 4 2 5 5 0 1 1



ART	BARCODE	ST.	PREZZO
04 11 89	8004537411898		20,25

10 CORNETTI ASSORTITI ACCIAIO INOX 2/4/6 MM EVA

UV1	UV2	IMBALLO
1	12	1/12/144 BC



8 0 0 4 5 3 7 4 1 1 8 9 8



ART	BARCODE	ST.	PREZZO
04 56 11	8004537456110		12,50

6 BOCCHETTE STELLA ACCIAIO INOSSIDABILE 4MM SCHNEIDER

UV1	UV2	IMBALLO
1	5	1/1 PG



8 0 0 4 5 3 7 4 5 6 1 1 0



ART	BARCODE	ST.	PREZZO
04 56 13	8004537456134		12,50

6 BOCCHETTE STELLA ACCIAIO INOSSIDABILE 6MM SCHNEIDER

UV1	UV2	IMBALLO
1	5	1/1 PG



8 0 0 4 5 3 7 4 5 6 1 3 4



ART	BARCODE	ST.	PREZZO
04 56 14	8004537456141		12,50

6 BOCCHETTE STELLA ACCIAIO INOSSIDABILE 8MM SCHNEIDER

UV1	UV2	IMBALLO
1	5	1/1 PG



8 0 0 4 5 3 7 4 5 6 1 4 1



ART	BARCODE	ST.	PREZZO
04 56 16	8004537456165		12,50

6 BOCCHETTE STELLA ACCIAIO INOSSIDABILE 10MM SCHNEIDER

UV1	UV2	IMBALLO
1	5	1/1 PG



8 0 0 4 5 3 7 4 5 6 1 6 5



ART	BARCODE	ST.	PREZZO
04 56 17	8004537456172		12,50

6 BOCCHETTE STELLA ACCIAIO INOSSIDABILE 12MM SCHNEIDER

UV1	UV2	IMBALLO
1	5	1/1 PG



8 0 0 4 5 3 7 4 5 6 1 7 2



ART	BARCODE	ST.	PREZZO
04 56 19	8004537456196		12,50

6 BOCCHETTE STELLA ACCIAIO INOSSIDABILE 14MM SCHNEIDER

UV1	UV2	IMBALLO
1	5	1/1 PG



8 0 0 4 5 3 7 4 5 6 1 9 6



ART	BARCODE	ST.	PREZZO
04 56 32	8004537456325		19,00

10 BOCCHETTE STELLA ACCIAIO INOSSIDABILE ASSORTITE SCHNEIDER

UV1	UV2	IMBALLO
1	5	1/1 PG



8 0 0 4 5 3 7 4 5 6 3 2 5



ART	BARCODE	ST.	PREZZO
04 56 23	8004537456233		12,50

6 BOCCHETTE ROTONDE ACCIAIO INOSSIDABILE 4MM SCHNEIDER

UV1	UV2	IMBALLO
1	5	1/1 PG



8 0 0 4 5 3 7 4 5 6 2 3 3



ART	BARCODE	ST.	PREZZO
04 56 25	8004537456257		12,50

6 BOCCHETTE ROTONDE ACCIAIO INOSSIDABILE 7MM SCHNEIDER

UV1	UV2	IMBALLO
1	5	1/1 PG



8 0 0 4 5 3 7 4 5 6 2 5 7



ART	BARCODE	ST.	PREZZO
04 56 26	8004537456264		12,50

6 BOCCHETTE ROTONDE ACCIAIO INOSSIDABILE 9MM SCHNEIDER

UV1	UV2	IMBALLO
1	5	1/1 PG



8 0 0 4 5 3 7 4 5 6 2 6 4



ART	BARCODE	ST.	PREZZO
04 56 27	8004537456271		12,50

6 BOCCHETTE ROTONDE ACCIAIO INOSSIDABILE 11MM SCHNEIDER

UV1	UV2	IMBALLO
1	5	1/1 PG



8 0 0 4 5 3 7 4 5 6 2 7 1



ART	BARCODE	ST.	PREZZO
04 56 33	8004537456332		19,00

10 BOCCHETTE ROTONDE ASSORTITE ACCIAIO INOSSIDAB. SCHNEIDER

UV1	UV2	IMBALLO
1	5	1/1 PG



8 0 0 4 5 3 7 4 5 6 3 3 2



ART	BARCODE	ST.	PREZZO
04 56 31	8004537456318		19,00

6 BOCCHETTE SPECIALI ASSORTITE ACCIAIO INOSSIDAB. SCHNEIDER

UV1	UV2	IMBALLO
1	5	1/1 PG



8 0 0 4 5 3 7 4 5 6 3 1 8



ART	BARCODE	ST.	PREZZO
04 56 34	8004537456349		34,30

6 BOCCHETTE A SIRINGA ACCIAIO INOSSIDABILE SCHNEIDER

UV1	UV2	IMBALLO
1	5	1/1 PG



8 0 0 4 5 3 7 4 5 6 3 4 9



ART	BARCODE	ST.	PREZZO
04 65 70	4028574022583		18,70

12 PEZZI SET BOCCHETTE PICCOLE ASSORTITI SCHNEIDER

UV1	UV2	IMBALLO
1	5	1/5 SP



4 0 2 8 5 7 4 0 2 2 5 8 3



ART	BARCODE	ST.	PREZZO
04 65 73	4028574022576		26,80

22 PEZZI SET BOCCHETTE ASSORTITE SCHNEIDER

UV1	UV2	IMBALLO
1	5	1/5 SP



4 0 2 8 5 7 4 0 2 2 5 7 6



ART	BARCODE	ST.	PREZZO
04 71 13	4018598330078		106,90

TEMPERATRICE CIOCCOLATO 60°C 1,5L MAIBACK

UV1	UV2	IMBALLO
1	2	1/4 PB



4 0 1 8 5 9 8 3 3 0 0 7 8



ART	BARCODE	ST.	PREZZO
04 71 14	4018598330108		29,00

CONTENITORE+COPERCHIO TEMPERATRICE 047113 INOX MAIBACK

UV1	UV2	IMBALLO
1	2	1/1 PB



4 0 1 8 5 9 8 3 3 0 1 0 8



ART	BARCODE	ST.	PREZZO
04 10 54	4000823035216		1,60

6 CARTA PIZZO ROTONDA Ø36CM ZENKER

UV1	UV2	IMBALLO
1	25	1/25 SP



4 0 0 0 8 2 3 0 3 5 2 1 6



ART	BARCODE	ST.	PREZZO
04 10 55	4000823035223		1,60

6 CARTA PIZZO RETTANGOLARE 20X40CM ZENKER

UV1	UV2	IMBALLO
1	25	1/25 SP



4 0 0 0 8 2 3 0 3 5 2 2 3



ART	BARCODE	ST.	PREZZO
04 10 74	4004094520983		1,35

24 CANDELINE TORTA WESTMARK

UV1	UV2	IMBALLO
1	12	1/12/72 BC



4 0 0 4 0 9 4 5 2 0 9 8 3

Setacciare Spargere Stendere



ART	BARCODE	ST.	PREZZO
04 10 37	8004537410372		7,30

SPARGIZUCCHERO A RETE ACCIAIO
INOSSIDABILE 0,35L EVA

UV1	UV2	IMBALLO
1	6	1/6/60 PB



8 0 0 4 5 3 7 4 1 0 3 7 2



ART	BARCODE	ST.	PREZZO
04 10 38	8004537410389		6,90

SPARGICACAO A FORI ACCIAIO
INOSSIDABILE 0,35L EVA

UV1	UV2	IMBALLO
1	6	1/6/60 PB



8 0 0 4 5 3 7 4 1 0 3 8 9



ART	BARCODE	ST.	PREZZO
04 10 39	8004537410396		4,15

SPARGIZUCCHERO A RETE ACCIAIO
INOSSIDABILE EVA

UV1	UV2	IMBALLO
1	6	1/6/96 SL



8 0 0 4 5 3 7 4 1 0 3 9 6



ART	BARCODE	ST.	PREZZO
04 56 40	8004537456400		5,95

SPARGIFARINA ACCIAIO INOSSIDABILE
Ø10CM EVA

UV1	UV2	IMBALLO
1	6	1/12/48 SL



8 0 0 4 5 3 7 4 5 6 4 0 0



ART	BARCODE	ST.	PREZZO
04 13 20	4004094321474		8,10

SETACCIO FARINA/ZUCCHERO A VELO
ABS WESTMARK

UV1	UV2	IMBALLO
1	4	1/8 AL



4 0 0 4 0 9 4 3 2 1 4 7 4



ART	BARCODE	ST.	PREZZO
04 11 47	4000270693748		7,70

MATTARELLO LEGNO DI FAGGIO FSC
25CM ASSALE METALLO KESPER

UV1	UV2	IMBALLO
1	5	1/5 SL



4 0 0 0 2 7 0 6 9 3 7 4 8



ART	BARCODE	ST.	PREZZO
04 11 43	4000270693786		3,95

MATTARELLO LEGNO DI FAGGIO FSC Ø4
X 40CM KESPER

UV1	UV2	IMBALLO
1	5	1/5 SL



4 0 0 0 2 7 0 6 9 3 7 8 6



ART	BARCODE	ST.	PREZZO
04 11 62	8004537411621		12,50

MATTARELLO ANTIADERENTE 45CM EVA

UV1	UV2	IMBALLO
1	4	1/24 PB



8 0 0 4 5 3 7 4 1 1 6 2 1



ART	BARCODE	ST.	PREZZO
04 15 94	8004537415940		14,60

MATTARELLO MARMO CON BASE IN
LEGNO 26CM EVA

UV1	UV2	IMBALLO
1	6	1/6 PB



8 0 0 4 5 3 7 4 1 5 9 4 0



ART	BARCODE	ST.	PREZZO
04 11 50	4000270693779		3,90

RULLO STENDIPASTA LEGNO DI FAGGIO
FSC 7,2CM KESPER

UV1	UV2	IMBALLO
1	5	1/10 SL



4 0 0 0 2 7 0 6 9 3 7 7 9



ART	BARCODE	ST.	PREZZO
04 11 21	8004537411218	A	6,80

RULLO PER LOSANGHE PLASTICA
BIANCO EVA

UV1	UV2	IMBALLO
1	12	1/12/72 CD



8 0 0 4 5 3 7 4 1 1 2 1 8



ART	BARCODE	ST.	PREZZO
04 11 22	8004537411225		7,15

RULLO BUCASFOGLIA PLASTICA
BIANCO EVA

UV1	UV2	IMBALLO
1	12	1/12/72 CD



8 0 0 4 5 3 7 4 1 1 2 2 5



ART	BARCODE	ST.	PREZZO
04 11 09	8004537411096	H	4,95

RULLO TAGLIASFOGLIA STRUDEL
21,5X7,5CM EVA

UV1	UV2	IMBALLO
1	12	1/12/72 CD



8 0 0 4 5 3 7 4 1 1 0 9 6



ART	BARCODE	ST.	PREZZO
04 06 90	8004537406900		31,00

TAGLIAPASTA 6 ROTELLE ACCIAIO
INOSSIDABILE EVA

UV1	UV2	IMBALLO
1	6	1/24 LB



8 0 0 4 5 3 7 4 0 6 9 0 0



ART	BARCODE	ST.	PREZZO
04 06 91	8004537406917		42,50

TAGLIAPASTA DOPPIO 10 ROTELLE
ACCIAIO INOSSIDABILE EVA

UV1	UV2	IMBALLO
1	4	1/24 LB



8 0 0 4 5 3 7 4 0 6 9 1 7



ART	BARCODE	ST.	PREZZO
04 10 18	4000270691256		15,20

6 UTENSILI PASTICCERIA BAMBINI
LEGNO DI FAGGIO FSC KESPER

UV1	UV2	IMBALLO
1	5	1/5 SP



4 0 0 0 2 7 0 6 9 1 2 5 6



ART	BARCODE	ST.	PREZZO
04 11 42	4000270681226		25,50

SPIANATOIA IN LEGNO STRATIFICATO
FSC 68X48CM KESPER

UV1	UV2	IMBALLO
1	5	1/5 SP



4 0 0 0 2 7 0 6 8 1 2 2 6



ART	BARCODE	ST.	PREZZO
04 11 60	4000270681264		18,50

SPIANATOIA IN LEGNO STRATIFICATO
FSC 58X38 CM KESPER

UV1	UV2	IMBALLO
1	5	1/5 SP



4 0 0 0 2 7 0 6 8 1 2 6 4



ART	BARCODE	ST.	PREZZO
04 33 32	8004537433326		22,90

SPIANATOIA/TAGLIERE IN MARMO
40X30CM EVA

UV1	UV2	IMBALLO
1	4	1/3 PB



8 0 0 4 5 3 7 4 3 3 3 2 6



ART	BARCODE	ST.	PREZZO
04 10 72	4004094301865		21,60

SPIANATOIA SILICONE 61,5X42 CM
WESTMARK

UV1	UV2	IMBALLO
1	3	1/3/24 HB



4 0 0 4 0 9 4 3 0 1 8 6 5



ART	BARCODE	ST.	PREZZO
04 10 01	4019889016268		17,80

SPIANATOIA IN SILICONE "FLEXIFORM"
60X40 CM LURCH

UV1	UV2	IMBALLO
1	6	1/6 PB



4 0 1 9 8 8 9 0 1 6 2 6 8



ART	BARCODE	ST.	PREZZO
04 10 02	4019889012451		15,00

TAPPETINO PER FORNO IN SILICONE
"FLEXIFORM" 40X30 CM LURCH

UV1	UV2	IMBALLO
1	6	1/6/24 PB



4 0 1 9 8 8 9 0 1 2 4 5 1

Trasportare Conservare



ART	BARCODE	ST.	PREZZO
04 14 60	7610859148544		12,50

PORTA TORTE RETTANGOLARE 'JOHN'
PP 43,5X29,5X9 CM ROTHO

UV1	UV2	IMBALLO
1	4	1/4 AL



7 6 1 0 8 5 9 1 4 8 5 4 4



ART	BARCODE	ST.	PREZZO
04 14 61	7610859153111		16,95

PORTA TORTE RETTANGOLARE 'JOHN'
PP 43,5X29,5X9 CM ROTHO

UV1	UV2	IMBALLO
1	2	1/2 AL



7 6 1 0 8 5 9 1 5 3 1 1 1



ART	BARCODE	ST.	PREZZO
04 14 63	7610859148582		11,25

PORTA TORTE GUGELHUPF 'FRESH' PP
30,5X28,5X17CM ROTHO

UV1	UV2	IMBALLO
1	2	1/2 AL



7 6 1 0 8 5 9 1 4 8 5 8 2



ART	BARCODE	ST.	PREZZO
04 14 64	7610859148506		8,55

PORTA TORTE RETTANGOLARE 'FRESH'
PP 36X16,5X16,5 CM ROTHO

UV1	UV2	IMBALLO
1	6	1/3 AL



7 6 1 0 8 5 9 1 4 8 5 0 6



ART	BARCODE	ST.	PREZZO
04 14 65	7610859148520		14,20

PORTA TORTA 'FRESH' PP 35,5X34,5X16,5
CM ROTHO

UV1	UV2	IMBALLO
1	3	1/3 AL



7 6 1 0 8 5 9 1 4 8 5 2 0



ART	BARCODE	ST.	PREZZO
04 14 62	7610859153500		21,20

PORTA TORTE RETTANGOLARE 'FRESH'
PP 43,5X29,5X11 CM ROTHO

UV1	UV2	IMBALLO
1	3	1/3 AL



7 6 1 0 8 5 9 1 5 3 5 0 0



ART	BARCODE	ST.	PREZZO
04 17 72	4008256140057		10,30

CONTENITORE PLUM CAKE 35X17X10CM

UV1	UV2	IMBALLO
1	4	1/10 SP



4 0 0 8 2 5 6 1 4 0 0 5 7



ART	BARCODE	ST.	PREZZO
04 18 75	4008256140217		10,20

CONTENITORE TORTE ACCIAIO
INOSSIDABILE 30CM

UV1	UV2	IMBALLO
1	8	1/8 SP



4 0 0 8 2 5 6 1 4 0 2 1 7



ART	BARCODE	ST.	PREZZO
07 60 11	4033051027722	A	5,40

SCATOLA BISCOTTI RETTAN
'WINTERZAUBER' 14,7X11,5X5,7CM

UV1	UV2	IMBALLO
1	12	1/12/96 BK



4 0 3 3 0 5 1 0 2 7 7 2 2



ART	BARCODE	ST.	PREZZO
07 60 97*	4033051025155	H	6,80

SCATOLA BISCOTTI QUADRA 'HERZERL'
10X10X9,5CM GAWOL

UV1	UV2	IMBALLO
1	12	1/12/48 BK



4 0 3 3 0 5 1 0 2 5 1 5 5



ART	BARCODE	ST.	PREZZO
07 60 66	4033051028293	A	5,70

SCATOLA BISCOTTI RETTANG 'BUON
NATALE' 14,7X11,5X5,7CM GAWOL

UV1	UV2	IMBALLO
1	12	1/12/96 BK



4 0 3 3 0 5 1 0 2 8 2 9 3



ART	BARCODE	ST.	PREZZO
07 60 67	4033051028347	A	7,10

SCATOLA BISCOTTI RETTANG 'BUON
NATALE' 16,5X12,5X7CM GAWOL

UV1	UV2	IMBALLO
1	4	1/4/32 BK



4 0 3 3 0 5 1 0 2 8 3 4 7



ART	BARCODE	ST.	PREZZO
07 60 68	4033051028316	A	9,20

SCATOLA BISCOTTI RETTANGOL 'BUON NATALE' 22,3X16,7X7CM GAWOL

UV1	UV2	IMBALLO
1	6	1/6/24 BK



4 0 3 3 0 5 1 0 2 8 3 1 6



ART	BARCODE	ST.	PREZZO
07 60 69	4033051028286	A	15,50

SCATOLA BISCOTTI RETTANG 'BUON NATALE' 28,7X23,9X9,5CM GAWOL

UV1	UV2	IMBALLO
1	6	1/6/12 BK



4 0 3 3 0 5 1 0 2 8 2 8 6



ART	BARCODE	ST.	PREZZO
07 60 70	4033051028323	A	24,50

SCATOLA BISCOTTI RETTAN 'BUON NATALE' 35,5X23,5X10CM GAWOL

UV1	UV2	IMBALLO
1	6	1/6/12 BK



4 0 3 3 0 5 1 0 2 8 3 2 3



ART	BARCODE	ST.	PREZZO
07 60 71	4033051028309	A	13,00

SCATOLA BISCOTTI QUADRA 'BUON NATALE' 22,2X22,2X8,5CM GAWOL

UV1	UV2	IMBALLO
1	6	1/6/24 BK



4 0 3 3 0 5 1 0 2 8 3 0 9



ART	BARCODE	ST.	PREZZO
07 60 72	4033051028330	A	8,60

SCATOLA BISCOTTI ROTONDA 'BUON NATALE' Ø18XH9,5CM GAWOL

UV1	UV2	IMBALLO
1	6	1/6/24 BK



4 0 3 3 0 5 1 0 2 8 3 3 0



ART	BARCODE	ST.	PREZZO
07 60 75	4033051028255	A	4,85

SCATOLA BISCOTTI RETTANG 'XMAS EVENING' 14X8,8X6,4CM GAWOL

UV1	UV2	IMBALLO
1	12	1/12/72 BK



4 0 3 3 0 5 1 0 2 8 2 5 5



ART	BARCODE	ST.	PREZZO
07 60 76	4033051028163	A	5,40

SCATOLA BISCOTTI RETTAN 'XMAS EVENING' 14,7X11,5X5,7CM GAWOL

UV1	UV2	IMBALLO
1	12	1/12/96 BK



4 0 3 3 0 5 1 0 2 8 1 6 3



ART	BARCODE	ST.	PREZZO
07 60 77	4033051028248	A	7,90

SCATOLA BISCOTTI RETTANG 'XMAS EVENING' 19,5X15,3X7CM GAWOL

UV1	UV2	IMBALLO
1	6	1/6/48 BK



4 0 3 3 0 5 1 0 2 8 2 4 8



ART	BARCODE	ST.	PREZZO
07 60 78	4033051028200	A	12,80

SCATOLA BISCOTTI RETTANG 'XMAS EVENING' 26X20,2X7CM GAWOL

UV1	UV2	IMBALLO
1	6	1/6/24 BK



4 0 3 3 0 5 1 0 2 8 2 0 0



ART	BARCODE	ST.	PREZZO
07 60 79	4033051028217	A	4,10

SCATOLA BISCOTTI QUADRA 'XMAS EVENING' 10,3X10,3X5,5CM GAWOL

UV1	UV2	IMBALLO
1	12	1/12/72 BK



4 0 3 3 0 5 1 0 2 8 2 1 7



ART	BARCODE	ST.	PREZZO
07 60 80	4033051028132	A	9,10

SCATOLA BISCOTTI QUADRA 'XMAS EVENING' 15X15X7,5CM GAWOL

UV1	UV2	IMBALLO
1	6	1/6/48 BK



4 0 3 3 0 5 1 0 2 8 1 3 2



ART	BARCODE	ST.	PREZZO
07 60 01	4033051028903	A	6,80

SCATOLA BISCOTTI RETTANGOLARE 'NATURE' 17,7X10,5X4 CM GAWOL

UV1	UV2	IMBALLO
1	12	1/12/96 BK



4 0 3 3 0 5 1 0 2 8 9 0 3



ART	BARCODE	ST.	PREZZO
07 60 02	4033051028866	A	5,40

SCATOLA BISCOTTI RETTANGOLARE
'NATURE' 14,7X11,5X5,7CM GAWOL

UV1	UV2	IMBALLO
1	12	1/12/96 BK



4 0 3 3 0 5 1 0 2 8 8 6 6



ART	BARCODE	ST.	PREZZO
07 60 03	4033051028804	A	9,10

SCATOLA BISCOTTI QUADRA 'NATURE'
15X15X7,5CM GAWOL

UV1	UV2	IMBALLO
1	6	1/6/48 BK



4 0 3 3 0 5 1 0 2 8 8 0 4



ART	BARCODE	ST.	PREZZO
07 60 04	4033051028798	A	10,40

SCATOLA BISCOTTI QUADRA 'NATURE'
18,7X18,7X7,2CM GAWOL

UV1	UV2	IMBALLO
1	6	1/6/24 BK



4 0 3 3 0 5 1 0 2 8 7 9 8



ART	BARCODE	ST.	PREZZO
07 60 05	4033051028880	A	15,20

SCATOLA BISCOTTI RETTANGOLARE
'NATURE' 26X20,2X8,3 CM GAWOL

UV1	UV2	IMBALLO
1	6	1/6/24 BK



4 0 3 3 0 5 1 0 2 8 8 8 0



ART	BARCODE	ST.	PREZZO
07 60 06	4033051028897	A	24,50

SCATOLA BISCOTTI RETTANGOLAR
'NATURE' 35,5X23,5X10 CM GAWOL

UV1	UV2	IMBALLO
1	6	1/6/12 BK



4 0 3 3 0 5 1 0 2 8 8 9 7



ART	BARCODE	ST.	PREZZO
07 60 44	4033051028750	A	6,10

SCATOLA BISCOTTI RETTANGOL
'AURELIA' 14,2X10,1X7,3 CM GAWOL

UV1	UV2	IMBALLO
1	6	1/12/72 BK



4 0 3 3 0 5 1 0 2 8 7 5 0



ART	BARCODE	ST.	PREZZO
07 60 45	4033051028729	A	9,20

SCATOLA BISCOTTI QUADRA 'AURELIA'
15X15X7,5CM GAWOL

UV1	UV2	IMBALLO
1	6	1/6/48 BK



4 0 3 3 0 5 1 0 2 8 7 2 9



ART	BARCODE	ST.	PREZZO
07 60 46	4033051028712	A	10,40

SCATOLA BISCOTTI QUADRA 'AURELIA'
18,7X18,7X7,2CM GAWOL

UV1	UV2	IMBALLO
1	6	1/6/24 BK



4 0 3 3 0 5 1 0 2 8 7 1 2



ART	BARCODE	ST.	PREZZO
07 60 47	4033051028736	A	9,20

SCATOLA BISCOTTI RETTANGOLARE
'AURELIA' 22,3X16,7X7CM GAWOL

UV1	UV2	IMBALLO
1	6	1/6/24 BK



4 0 3 3 0 5 1 0 2 8 7 3 6



ART	BARCODE	ST.	PREZZO
07 61 85	4033051029634	A	5,40

SCATOLA BISCOTTI RETT. 'GOLDEN
DEER' 14,7X11,5X5,7CM GAWOL

UV1	UV2	IMBALLO
1	12	1/12/96 BK



4 0 3 3 0 5 1 0 2 9 6 3 4



ART	BARCODE	ST.	PREZZO
07 61 90	4033051029566	A	5,25

SCATOLA BISCOTTI QUADRA 'GNOMI'
10X10X7 CM GAWOL

UV1	UV2	IMBALLO
1	12	1/12/72 BK



4 0 3 3 0 5 1 0 2 9 5 6 6



ART	BARCODE	ST.	PREZZO
07 61 91	4033051029559	A	4,60

SCATOLA BISCOTTI RETTANG. 'GNOMI'
15,5X10X5,7CM GAWOL

UV1	UV2	IMBALLO
1	12	1/12/96 BK



4 0 3 3 0 5 1 0 2 9 5 5 9



ART	BARCODE	ST.	PREZZO
07 61 94	4033051029436	A	9,20

SCATOLA BISCOTTI ROTONDA 'GNOMI' Ø18X9,5CM GAWOL

UV1	UV2	IMBALLO
1	6	1/6/24 BK



4 0 3 3 0 5 1 0 2 9 4 3 6



ART	BARCODE	ST.	PREZZO
07 61 96	4033051029689	A	8,80

SCATOLA BISCOTTI RETT. 'XMAS SHOPPING' 22,3X16,7X7CM GAWOL

UV1	UV2	IMBALLO
1	6	1/6/24 BK



4 0 3 3 0 5 1 0 2 9 6 8 9



ART	BARCODE	ST.	PREZZO
07 61 97	4033051029672	A	12,80

SCATOLA BISCOTTI RETTANG 'XMAS SHOPPING' 26X20,2X7CM GAWOL

UV1	UV2	IMBALLO
1	6	1/6/24 BK



4 0 3 3 0 5 1 0 2 9 6 7 2



ART	BARCODE	ST.	PREZZO
07 61 98	4033051029696	A	15,50

SCATOLA BISCOTTI OTTAG 'XMAS SHOPPING' 28,7X23,9X9,5CM GAWOL

UV1	UV2	IMBALLO
1	6	1/6/12 BK



4 0 3 3 0 5 1 0 2 9 6 9 6



ART	BARCODE	ST.	PREZZO
07 61 99	4033051029702	A	12,40

SCATOLA BISCOTTI ROTONDA 'XMAS SHOPPING' Ø21XH12CM GAWOL

UV1	UV2	IMBALLO
1	4	1/4/16 BK



4 0 3 3 0 5 1 0 2 9 7 0 2



ART	BARCODE	ST.	PREZZO
07 59 93	4000270382413	A	2,10

SCATOLA BISCOTTI RETT 'HAPPY CHRISTMAS' 14,5X10,5X4,5CM KESP

UV1	UV2	IMBALLO
1	6	1/10 BK



4 0 0 0 2 7 0 3 8 2 4 1 3



ART	BARCODE	ST.	PREZZO
07 59 94	4000270382406	A	3,30

SCATOLA BISCOTTI RETT 'VINTAGE STAR' 20,4X13,5X8,2CM KESPER

UV1	UV2	IMBALLO
1	6	1/6 BK



4 0 0 0 2 7 0 3 8 2 4 0 6



ART	BARCODE	ST.	PREZZO
07 61 24	4033051027272	H	13,50

SCATOLA 'JUKE BOX' 21X13,5X6CM GAWOL

UV1	UV2	IMBALLO
1	6	1/6/24 BK



4 0 3 3 0 5 1 0 2 7 2 7 2



ART	BARCODE	ST.	PREZZO
07 61 23	4033051027265	H	13,50

SCATOLA 'SLOT MACHINE' 21X13,5X6CM GAWOL

UV1	UV2	IMBALLO
1	6	1/6/24 BK



4 0 3 3 0 5 1 0 2 7 2 6 5



ART	BARCODE	ST.	PREZZO
07 61 26	4033051024875	A	8,90

SCATOLA RETRO 'FRIDGE' ASSORTITA 20X10X7CM GAWOL

UV1	UV2	IMBALLO
1	6	1/6/36 BK



4 0 3 3 0 5 1 0 2 4 8 7 5

KAUFGUT[®]



Tavola - Tisch

Caffè The



ART	BARCODE	ST.	PREZZO
01 27 16	8593419351181		20,30

TEIERA VETRO+COPERCHIO
INOX+COLINO "CHARME" 1,1L SIMAX

UV1	UV2	IMBALLO
1	6	1/6 PB



8 5 9 3 4 1 9 3 5 1 1 8 1



ART	BARCODE	ST.	PREZZO
01 27 11	8593419331213	A	14,90

6 PEZZI SET TEIERA 'KON'+FILTRO+4
TAZZE VETRO 1,5L BOHEMIA

UV1	UV2	IMBALLO
1	5	1/5 PB



8 5 9 3 4 1 9 3 3 1 2 1 3



ART	BARCODE	ST.	PREZZO
01 27 12	8593419382956		19,30

TEIERA
CILINDRICA+COPERCHIO+COLINO
VETRO 1,3L SIMAX

UV1	UV2	IMBALLO
1	6	1/12 PB



8 5 9 3 4 1 9 3 8 2 9 5 6



ART	BARCODE	ST.	PREZZO
01 27 18	8593419328145		13,70

TEIERA +COPERCHIO+COLINO 'MARTHA'
VETRO 1,5L SIMAX

UV1	UV2	IMBALLO
1	12	1/12 WB



8 5 9 3 4 1 9 3 2 8 1 4 5



ART	BARCODE	ST.	PREZZO
01 27 30	8593419327568		11,90

TEIERA+COPERCHIO+FILTRO
MICROONDE VETRO 1,5L SIMAX

UV1	UV2	IMBALLO
1	6	1/18 CT



8 5 9 3 4 1 9 3 2 7 5 6 8



ART	BARCODE	ST.	PREZZO
01 27 19	8593419327117		12,30

TEIERA+COPERCHIO 'EVA' VETRO 1,0L
SIMAX

UV1	UV2	IMBALLO
1	6	1/6 WB



8 5 9 3 4 1 9 3 2 7 1 1 7



ART	BARCODE	ST.	PREZZO
01 27 29	4000848451817	A	10,20

TEIERA VETRO PER MICROONDE+FILTRO
1,8L

UV1	UV2	IMBALLO
1	4	1/4 SL



4 0 0 0 8 4 8 4 5 1 8 1 7



ART	BARCODE	ST.	PREZZO
01 27 26	4000848800400		6,30

TEIERA VETRO 'RONDO' 1,25 LITRI

UV1	UV2	IMBALLO
1	6	1/6 SL



4 0 0 0 8 4 8 8 0 0 4 0 0



ART	BARCODE	ST.	PREZZO
01 27 32	4000848460505		5,20

TEIERA VETRO MICROONDE 'VENEZIA'
0,5L

UV1	UV2	IMBALLO
1	4	1/4 BK



4 0 0 0 8 4 8 4 6 0 5 0 5



ART	BARCODE	ST.	PREZZO
01 27 33	4000848460307		6,50

TEIERA VETRO MICROONDE 'VENEZIA'
1,0L

UV1	UV2	IMBALLO
1	4	1/4 BK



4 0 0 0 8 4 8 4 6 0 3 0 7



ART	BARCODE	ST.	PREZZO
01 27 35	4000848460611		7,65

TEIERA VETRO MICROONDE+FILTRO
'VENEZIA' 1,5L

UV1	UV2	IMBALLO
1	4	1/4 BK



4 0 0 0 8 4 8 4 6 0 6 1 1



ART	BARCODE	ST.	PREZZO
01 27 46	8004537127461		11,50

INFUSIERA VETRO/ACCIAIO
INOSSIDABILE 350ML EVA

UV1	UV2	IMBALLO
1	6	1/30 PB



8 0 0 4 5 3 7 1 2 7 4 6 1



ART	BARCODE	ST.	PREZZO
01 27 47	8004537127478		18,60

INFUSIERA VETRO/ACCIAIO
INOSSIDABILE 800ML EVA

UV1	UV2	IMBALLO
1	4	1/24 PB



8 0 0 4 5 3 7 1 2 7 4 7 8



ART	BARCODE	ST.	PREZZO
12 22 15	8033237337153		12,90

INFUSIERA VETRO/ACCIAIO
INOSSIDABILE 350ML FOREVER

UV1	UV2	IMBALLO
1	6	1/30 PB



8 0 3 3 2 3 7 3 3 7 1 5 3



ART	BARCODE	ST.	PREZZO
12 22 16	8033237337160		19,00

INFUSIERA VETRO/ACCIAIO
INOSSIDABILE 800ML FOREVER

UV1	UV2	IMBALLO
1	4	1/24 PB



8 0 3 3 2 3 7 3 3 7 1 6 0



ART	BARCODE	ST.	PREZZO
01 27 56	8004537127560		20,80

TEIERA 'KYOTO' GHISA 0,3L EVA

UV1	UV2	IMBALLO
1	6	1/12 LB



8 0 0 4 5 3 7 1 2 7 5 6 0



ART	BARCODE	ST.	PREZZO
01 27 57	8004537127577		25,80

TEIERA 'KYOTO' GHISA 0,55L EVA

UV1	UV2	IMBALLO
1	6	1/12 LB



8 0 0 4 5 3 7 1 2 7 5 7 7



ART	BARCODE	ST.	PREZZO
01 27 58	8004537127584		31,00

TEIERA 'KYOTO' GHISA 0,9L EVA

UV1	UV2	IMBALLO
1	4	1/8 LB



8 0 0 4 5 3 7 1 2 7 5 8 4



ART	BARCODE	ST.	PREZZO
01 27 59	8004537127591		36,50

TEIERA 'KYOTO' GHISA 1,2L EVA

UV1	UV2	IMBALLO
1	4	1/8 LB



8 0 0 4 5 3 7 1 2 7 5 9 1



ART	BARCODE	ST.	PREZZO
07 02 30	4004094248467		11,80

SCALDA-TE' ACCIAIO INOSSIDABILE 1
LUMINO Ø 15 CM WESTMARK

UV1	UV2	IMBALLO
1	4	1/4/36 PB



4 0 0 4 0 9 4 2 4 8 4 6 7



ART	BARCODE	ST.	PREZZO
02 22 54	4004094157561		6,50

FILTRO TÉ PERMANENTE PP WESTMARK

UV1	UV2	IMBALLO
1	5	1/5/30 PB



4 0 0 4 0 9 4 1 5 7 5 6 1



ART	BARCODE	ST.	PREZZO
02 23 05	8004537223057		2,60

CUOCI TE' ACCIAIO INOSSIDABILE EVA

UV1	UV2	IMBALLO
1	12	1/12/288 CD



8 0 0 4 5 3 7 2 2 3 0 5 7



ART	BARCODE	ST.	PREZZO
02 23 06	8004537223064		3,30

CUOCI TE' A CUCCHIAIO ACCIAIO
INOSSIDABILE 16CM Ø4CM EVA

UV1	UV2	IMBALLO
1	12	1/12/288 CD



8 0 0 4 5 3 7 2 2 3 0 6 4



ART	BARCODE	ST.	PREZZO
02 23 13	8004537223132		4,65

CUOCI TE' CUCCHIAIO ACCIAIO
INOSSIDABILE 18CM Ø6,5CM EVA

UV1	UV2	IMBALLO
1	12	1/12/96 CD



8 0 0 4 5 3 7 2 2 3 1 3 2



ART	BARCODE	ST.	PREZZO
02 23 10	8004537223101		3,05

**CUOCI TE' CAMPANA ACCIAIO
INOSSIDABILE 18/8 Ø 4,5CM EVA**

UV1	UV2	IMBALLO
1	12	1/12/144 CD



8 0 0 4 5 3 7 2 2 3 1 0 1



ART	BARCODE	ST.	PREZZO
02 23 22	8004537223224		4,00

**CUOCI TE' A CAMPANA ACCIAIO
INOSSIDABILE Ø 6,5CM EVA**

UV1	UV2	IMBALLO
1	12	1/12/144 CD



8 0 0 4 5 3 7 2 2 3 2 2 4



ART	BARCODE	ST.	PREZZO
02 23 12	8004537223125		4,30

**CUOCI TE' A CAMPANA ACCIAIO
INOSSIDABILE Ø 7,5CM EVA**

UV1	UV2	IMBALLO
1	12	1/12/144 CD



8 0 0 4 5 3 7 2 2 3 1 2 5



ART	BARCODE	ST.	PREZZO
02 23 04	8004537223040	A	4,80

**CUOCITE' ACCIAIO INOSSIDAB.SILICONE
ASSORTITO IN DISPLAY EVA**

UV1	UV2	IMBALLO
12	24	1/12/48 DB



8 0 0 4 5 3 7 2 2 3 0 4 0



ART	BARCODE	ST.	PREZZO
02 23 28	8004627110007		2,90

**CUOCITE ACCIAIO INOSSIDABILE
COLORI ASSORTITI**

UV1	UV2	IMBALLO
1	10	1/40 CD



8 0 0 4 6 2 7 1 1 0 0 0 7



ART	BARCODE	ST.	PREZZO
02 23 26	8004537223262		4,95

**CUOCI TE'/SPEZIE GIGANTE ACCIAIO
INOSSIDABILE 6CM EVA**

UV1	UV2	IMBALLO
1	12	1/12/144 CD



8 0 0 4 5 3 7 2 2 3 2 6 2



ART	BARCODE	ST.	PREZZO
02 23 24	8004537223248	A	9,90

**INFUSORE TE' / SPEZIE ACCIAIO
INOSSIDABILE Ø 11,5CM EVA**

UV1	UV2	IMBALLO
1	6	1/6/48 PB



8 0 0 4 5 3 7 2 2 3 2 4 8



ART	BARCODE	ST.	PREZZO
02 23 25*	8004537223255	H	11,80

**INFUSORE TE' / SPEZIE ACCIAIO
INOSSIDABILE Ø 14 CM EVA**

UV1	UV2	IMBALLO
1	6	1/6/48 PB



8 0 0 4 5 3 7 2 2 3 2 5 5



ART	BARCODE	ST.	PREZZO
02 23 23	8004537223231		5,20

**FILTRO TÈ UNIVERSALE ACCIAIO
INOSSIDABILE EVA**

UV1	UV2	IMBALLO
1	6	1/6/24 HB



8 0 0 4 5 3 7 2 2 3 2 3 1



ART	BARCODE	ST.	PREZZO
02 23 20	4004094153150		2,20

**FILTRO TE DI COTONE Ø 9 CM
WESTMARK**

UV1	UV2	IMBALLO
1	10	1/10/100 PH



4 0 0 4 0 9 4 1 5 3 1 5 0



ART	BARCODE	ST.	PREZZO
04 18 95	4004094158476		5,10

**PINZA PER BUSTINE DI TE' ACCIAIO
INOSSIDABILE 12 CM WESTMARK**

UV1	UV2	IMBALLO
1	2	1/2/24 CD



4 0 0 4 0 9 4 1 5 8 4 7 6



ART	BARCODE	ST.	PREZZO
02 23 30	4006508136315		5,40

10 FILTRI TE'+SUPPORTO

UV1	UV2	IMBALLO
1	6	1/6 PB



4 0 0 6 5 0 8 1 3 6 3 1 5



ART	BARCODE	ST.	PREZZO
02 23 31	4006508125425		4,50

100 FILTRI TE' UTILIZZABILI CON SUPPORTO

UV1	UV2	IMBALLO
1	8	1/8 PB



4 0 0 6 5 0 8 1 2 5 4 2 5



ART	BARCODE	ST.	PREZZO
02 23 32	4006508162826		4,50

80 FILTRI TE' UTILIZZABILI SENZA SUPPORTO

UV1	UV2	IMBALLO
1	8	1/8 PB



4 0 0 6 5 0 8 1 6 2 8 2 6



ART	BARCODE	ST.	PREZZO
04 15 36	4000270589201	A	15,80

PORTA BUSTINE TE' FSC BIANCO 9 SCOMPARTI 22X22X9.6 CM KESPER

UV1	UV2	IMBALLO
1	4	1/4 SP



4 0 0 0 2 7 0 5 8 9 2 0 1



ART	BARCODE	ST.	PREZZO
04 15 38	4000270589027		13,80

PORTA BUSTINE TE' BAMBU FSC 6 SCOMPARTI 22X16X9CM KESPER

UV1	UV2	IMBALLO
1	3	1/3 SP



4 0 0 0 2 7 0 5 8 9 0 2 7



ART	BARCODE	ST.	PREZZO
04 15 39	4000270589034		15,50

PORTA BUSTINE TE'BAMBU' FSC 6 SCOMPARTI 22X21X9,5CM KESPER

UV1	UV2	IMBALLO
1	4	1/4 SP



4 0 0 0 2 7 0 5 8 9 0 3 4



ART	BARCODE	ST.	PREZZO
04 15 29	4000270589010		20,90

PORTA BUSTINE TE' BAMBU' FSC 10 SCOMPARTI 36X20X9CM KESPER

UV1	UV2	IMBALLO
1	5	1/5 SP



4 0 0 0 2 7 0 5 8 9 0 1 0



ART	BARCODE	ST.	PREZZO
04 15 50	4000270589508		29,00

PORTABUSTINE/CAPSULE BAMBU'FSC+VETRO 30X10X31CM KESPER

UV1	UV2	IMBALLO
1	4	1/4 SP



4 0 0 0 2 7 0 5 8 9 5 0 8



ART	BARCODE	ST.	PREZZO
07 61 82	4000270382062		7,50

SCATOLA TÈ RETTANGOLARE ASSORTITO 20X14,5X8CM KESPER

UV1	UV2	IMBALLO
1	4	1/4/24 BK



4 0 0 0 2 7 0 3 8 2 0 6 2



ART	BARCODE	ST.	PREZZO
12 04 01	8033237331243		21,00

'MISS MOKA PRESTIGE' ALLUM-INDUZIONE 2 TAZZE 330G FOREVER

UV1	UV2	IMBALLO
1	6	1/6/24 PB



8 0 3 3 2 3 7 3 3 1 2 4 3



ART	BARCODE	ST.	PREZZO
12 04 02	8033237331250		24,50

'MISS MOKA PRESTIGE' ALLUM-INDUZIONE 3 TAZZE 490G FOREVER

UV1	UV2	IMBALLO
1	6	1/6/24 PB



8 0 3 3 2 3 7 3 3 1 2 5 0



ART	BARCODE	ST.	PREZZO
12 04 03	8033237331274		29,50

'MISS MOKA PRESTIGE' ALLUM-INDUZIONE 6 TAZZE 645G FOREVER

UV1	UV2	IMBALLO
1	6	1/6/12 PB



8 0 3 3 2 3 7 3 3 1 2 7 4



ART	BARCODE	ST.	PREZZO
12 04 04	8033237331281		37,50

'MISS MOKA PRESTIGE' ALLUM-INDUZIONE 9 TAZZE 673G FOREVER

UV1	UV2	IMBALLO
1	6	1/6/18 PB



8 0 3 3 2 3 7 3 3 1 2 8 1



ART	BARCODE	ST.	PREZZO
12 04 05*	8033237331298		42,50

**'MISS MOKA PRESTIGE' ALLUM-
INDUZIONE 12 TAZZE 931G FOREVER**

UV1	UV2	IMBALLO
1	6	1/6/18 PB



8 0 3 3 2 3 7 3 3 1 2 9 8



ART	BARCODE	ST.	PREZZO
12 02 51*	8033237332905		9,90

**MISS MOKA PRESTIGE 'AZZURRA'
ALLUMINIO 1 TAZZA FOREVER**

UV1	UV2	IMBALLO
1	12	1/12/48 PB



8 0 3 3 2 3 7 3 3 2 9 0 5



ART	BARCODE	ST.	PREZZO
12 02 52*	8033237332943		11,00

**MISS MOKA PRESTIGE 'AZZURRA'
ALLUMINIO 2 TAZZE FOREVER**

UV1	UV2	IMBALLO
1	12	1/12/48 PB



8 0 3 3 2 3 7 3 3 2 9 4 3



ART	BARCODE	ST.	PREZZO
12 02 53*	8033237332950		12,50

**MISS MOKA PRESTIGE 'AZZURRA'
ALLUMINIO 3 TAZZE FOREVER**

UV1	UV2	IMBALLO
1	6	1/6/36 PB



8 0 3 3 2 3 7 3 3 2 9 5 0



ART	BARCODE	ST.	PREZZO
12 02 54*	8033237332974		16,50

**MISS MOKA PRESTIGE 'AZZURRA'
ALLUMINIO 6 TAZZE FOREVER**

UV1	UV2	IMBALLO
1	6	1/6/24 PB



8 0 3 3 2 3 7 3 3 2 9 7 4



ART	BARCODE	ST.	PREZZO
12 02 41*	8033237332813		9,90

**MISS MOKA PRESTIGE 'LA VERDE'
ALLUMINIO 1 TAZZA FOREVER**

UV1	UV2	IMBALLO
1	12	1/12/48 PB



8 0 3 3 2 3 7 3 3 2 8 1 3



ART	BARCODE	ST.	PREZZO
12 02 42*	8033237332820		11,00

**MISS MOKA PRESTIGE 'LA VERDE'
ALLUMINIO 2 TAZZE FOREVER**

UV1	UV2	IMBALLO
1	12	1/12/48 PB



8 0 3 3 2 3 7 3 3 2 8 2 0



ART	BARCODE	ST.	PREZZO
12 02 43*	8033237332837		12,50

**MISS MOKA PRESTIGE 'LA VERDE'
ALLUMINIO 3 TAZZE FOREVER**

UV1	UV2	IMBALLO
1	6	1/6/36 PB



8 0 3 3 2 3 7 3 3 2 8 3 7



ART	BARCODE	ST.	PREZZO
12 02 44*	8033237332844		16,50

**MISS MOKA PRESTIGE 'LA VERDE'
ALLUMINIO 6 TAZZE FOREVER**

UV1	UV2	IMBALLO
1	6	1/6/24 PB



8 0 3 3 2 3 7 3 3 2 8 4 4



ART	BARCODE	ST.	PREZZO
12 02 11*	8033237332417	A	9,90

**MISS MOKA PRESTIGE 'LA ROSSA'
ALLUMINIO 1 TAZZA FOREVER**

UV1	UV2	IMBALLO
1	12	1/12/48 PB



8 0 3 3 2 3 7 3 3 2 4 1 7



ART	BARCODE	ST.	PREZZO
12 02 14*	8033237332448	A	16,50

**MISS MOKA PRESTIGE 'LA ROSSA'
ALLUMINIO 6 TAZZE FOREVER**

UV1	UV2	IMBALLO
1	6	1/6/24 PB



8 0 3 3 2 3 7 3 3 2 4 4 8



ART	BARCODE	ST.	PREZZO
12 07 02	8033237331922		46,00

**MISS MOKA PRESTIGE ELECTRO 6 TAZZE
FOREVER**

UV1	UV2	IMBALLO
1	4	1/8 PB



8 0 3 3 2 3 7 3 3 1 9 2 2



ART	BARCODE	ST.	PREZZO
12 01 07	8033237331656	A	7,35

'MISS MOKA PRESTIGE' ALLUMINIO 1/2 TAZZE 180G FOREVER

UV1	UV2	IMBALLO
1	18	1/18/72 PB



8 0 3 3 2 3 7 3 3 1 6 5 6



ART	BARCODE	ST.	PREZZO
12 01 08	8033237331670		52,50

'MISS MOKA PRESTIGE' ALLUMINIO 18 TAZZE FOREVER

UV1	UV2	IMBALLO
1	3	1/3/12 PB



8 0 3 3 2 3 7 3 3 1 6 7 0



ART	BARCODE	ST.	PREZZO
12 01 11	8033237331519		8,45

'MISS MOKA PRESTIGE NEW' ALLUMINIO 1/2 TAZZE FOREVER

UV1	UV2	IMBALLO
1	12	1/12/36 PB



8 0 3 3 2 3 7 3 3 1 5 1 9



ART	BARCODE	ST.	PREZZO
12 01 12	8033237331526		9,90

'MISS MOKA PRESTIGE NEW' ALLUMINIO 1 TAZZA FOREVER

UV1	UV2	IMBALLO
1	12	1/12/36 PB



8 0 3 3 2 3 7 3 3 1 5 2 6



ART	BARCODE	ST.	PREZZO
12 01 13	8033237331533		11,70

'MISS MOKA PRESTIGE NEW' ALLUMINIO 2 TAZZE FOREVER

UV1	UV2	IMBALLO
1	6	1/6/24 PB



8 0 3 3 2 3 7 3 3 1 5 3 3



ART	BARCODE	ST.	PREZZO
12 01 14	8033237331540		13,25

'MISS MOKA PRESTIGE NEW' ALLUMINIO 3 TAZZE FOREVER

UV1	UV2	IMBALLO
1	6	1/6/24 PB



8 0 3 3 2 3 7 3 3 1 5 4 0



ART	BARCODE	ST.	PREZZO
12 01 15	8033237331557		17,80

'MISS MOKA PRESTIGE NEW' ALLUMINIO 6 TAZZE FOREVER

UV1	UV2	IMBALLO
1	6	1/6/12 PB



8 0 3 3 2 3 7 3 3 1 5 5 7



ART	BARCODE	ST.	PREZZO
12 01 16	8033237331571		23,40

'MISS MOKA PRESTIGE NEW' ALLUMINIO 9 TAZZE FOREVER

UV1	UV2	IMBALLO
1	6	1/6/12 PB



8 0 3 3 2 3 7 3 3 1 5 7 1



ART	BARCODE	ST.	PREZZO
12 01 17	8033237331588		34,25

'MISS MOKA PRESTIGE NEW' ALLUMINIO 12 TAZZE FOREVER

UV1	UV2	IMBALLO
1	6	1/6/12 PB



8 0 3 3 2 3 7 3 3 1 5 8 8



ART	BARCODE	ST.	PREZZO
12 02 16	8033237332455		11,35

NEW MOKA PRESTIGE 'LA ROSSA' ALLUMINIO 1 TAZZA FOREVER

UV1	UV2	IMBALLO
1	12	1/12/36 PB



8 0 3 3 2 3 7 3 3 2 4 5 5



ART	BARCODE	ST.	PREZZO
12 02 17	8033237332462		12,80

NEW MOKA PRESTIGE 'LA ROSSA' ALLUMINIO 2 TAZZE FOREVER

UV1	UV2	IMBALLO
1	6	1/6/24 PB



8 0 3 3 2 3 7 3 3 2 4 6 2



ART	BARCODE	ST.	PREZZO
12 02 18	8033237332479		14,40

NEW MOKA PRESTIGE 'LA ROSSA' ALLUMINIO 3 TAZZE FOREVER

UV1	UV2	IMBALLO
1	6	1/6/24 PB



8 0 3 3 2 3 7 3 3 2 4 7 9



ART	BARCODE	ST.	PREZZO
12 02 19*	8033237332486		18,90

NEW MOKA PRESTIGE 'LA ROSSA'
ALLUMINIO 6 TAZZE FOREVER

UV1	UV2	IMBALLO
1	6	1/6/12 PB



8 0 3 3 2 3 7 3 3 2 4 8 6



ART	BARCODE	ST.	PREZZO
12 02 26*	8033237332554		11,35

NEW MOKA PRESTIGE 'NOBLESSE'
ALLUMINIO 1 TAZZA FOREVER

UV1	UV2	IMBALLO
1	12	1/12/36 PB



8 0 3 3 2 3 7 3 3 2 5 5 4



ART	BARCODE	ST.	PREZZO
12 02 27*	8033237332561		12,80

NEW MOKA PRESTIGE 'NOBLESSE'
ALLUMINIO 2 TAZZE FOREVER

UV1	UV2	IMBALLO
1	6	1/6/24 PB



8 0 3 3 2 3 7 3 3 2 5 6 1



ART	BARCODE	ST.	PREZZO
12 02 28*	8033237332578		14,40

NEW MOKA PRESTIGE 'NOBLESSE'
ALLUMINIO 3 TAZZE FOREVER

UV1	UV2	IMBALLO
1	6	1/6/24 PB



8 0 3 3 2 3 7 3 3 2 5 7 8



ART	BARCODE	ST.	PREZZO
12 02 29*	8033237332585		18,90

NEW MOKA PRESTIGE 'NOBLESSE'
ALLUMINIO 6 TAZZE FOREVER

UV1	UV2	IMBALLO
1	6	1/6/12 PB



8 0 3 3 2 3 7 3 3 2 5 8 5



ART	BARCODE	ST.	PREZZO
12 02 36*	8033237332653		12,00

NEW MOKA PRESTIGE 'WOODY'
ALLUMINIO 1 TAZZA FOREVER

UV1	UV2	IMBALLO
1	12	1/12/36 PB



8 0 3 3 2 3 7 3 3 2 6 5 3



ART	BARCODE	ST.	PREZZO
12 02 37*	8033237332660		13,80

NEW MOKA PRESTIGE 'WOODY'
ALLUMINIO 2 TAZZE FOREVER

UV1	UV2	IMBALLO
1	6	1/6/24 PB



8 0 3 3 2 3 7 3 3 2 6 6 0



ART	BARCODE	ST.	PREZZO
12 02 38*	8033237332677		15,30

NEW MOKA PRESTIGE 'WOODY'
ALLUMINIO 3 TAZZE FOREVER

UV1	UV2	IMBALLO
1	6	1/6/24 PB



8 0 3 3 2 3 7 3 3 2 6 7 7



ART	BARCODE	ST.	PREZZO
12 02 39*	8033237332684		19,90

NEW MOKA PRESTIGE 'WOODY'
ALLUMINIO 6 TAZZE FOREVER

UV1	UV2	IMBALLO
1	6	1/6/12 PB



8 0 3 3 2 3 7 3 3 2 6 8 4



ART	BARCODE	ST.	PREZZO
12 02 06*	8033237332356		12,20

NEW MOKA PRESTIGE 'RADICA'
ALLUMINIO 1 TAZZA FOREVER

UV1	UV2	IMBALLO
1	6	1/12/36 PB



8 0 3 3 2 3 7 3 3 2 3 5 6



ART	BARCODE	ST.	PREZZO
12 02 07*	8033237332370		14,25

NEW MOKA PRESTIGE 'RADICA'
ALLUMINIO 2 TAZZE FOREVER

UV1	UV2	IMBALLO
1	6	1/6/24 PB



8 0 3 3 2 3 7 3 3 2 3 7 0



ART	BARCODE	ST.	PREZZO
12 02 08*	8033237332387		16,00

NEW MOKA PRESTIGE 'RADICA'
ALLUMINIO 3 TAZZE FOREVER

UV1	UV2	IMBALLO
1	6	1/6/24 PB



8 0 3 3 2 3 7 3 3 2 3 8 7



ART	BARCODE	ST.	PREZZO
12 02 09	8033237332400		20,80

NEW MOKA PRESTIGE 'RADICA' ALLUMINIO 6 TAZZE FOREVER

UV1	UV2	IMBALLO
1	6	1/6/12 PB



8 0 3 3 2 3 7 3 3 2 4 0 0



ART	BARCODE	ST.	PREZZO
12 05 05	8033237330369	H	19,90

MISS COCO ALLUMINIO 6 TAZZE 610G FOREVER

UV1	UV2	IMBALLO
1	6	1/6/24 PB



8 0 3 3 2 3 7 3 3 0 3 6 9



ART	BARCODE	ST.	PREZZO
12 13 51	8033237333162		29,00

'MISS PERLA' ACCIAIO INOSSIDABILE 4 TAZZE 460G FOREVER

UV1	UV2	IMBALLO
1	6	1/6/24 PB



8 0 3 3 2 3 7 3 3 3 1 6 2



ART	BARCODE	ST.	PREZZO
12 13 52	8033237333179		33,00

'MISS PERLA' ACCIAIO INOSSIDABILE 6 TAZZE 600G FOREVER

UV1	UV2	IMBALLO
1	6	1/6/24 PB



8 0 3 3 2 3 7 3 3 3 1 7 9



ART	BARCODE	ST.	PREZZO
12 13 53	8033237333186		38,50

'MISS PERLA' ACCIAIO INOSSIDABILE 10 TAZZE 850G FOREVER

UV1	UV2	IMBALLO
1	6	1/6/18 PB



8 0 3 3 2 3 7 3 3 3 1 8 6



ART	BARCODE	ST.	PREZZO
12 13 02	8033237333322		17,50

'MISS CONNY' ACCIAIO INOSSIDABILE 2 TAZZE 380G FOREVER

UV1	UV2	IMBALLO
1	6	1/6/36 PB



8 0 3 3 2 3 7 3 3 3 3 2 2



ART	BARCODE	ST.	PREZZO
12 13 03	8033237333346		21,00

'MISS CONNY' ACCIAIO INOSSIDABILE 4 TAZZE 500G FOREVER

UV1	UV2	IMBALLO
1	6	1/6/24 PB



8 0 3 3 2 3 7 3 3 3 3 4 6



ART	BARCODE	ST.	PREZZO
12 13 04	8033237333360		25,00

'MISS CONNY' ACCIAIO INOSSIDABILE 6 TAZZE 600G FOREVER

UV1	UV2	IMBALLO
1	6	1/6/24 PB



8 0 3 3 2 3 7 3 3 3 3 6 0



ART	BARCODE	ST.	PREZZO
12 13 05	8033237333308		29,50

'MISS CONNY' ACCIAIO INOSSIDABILE 10 TAZZE 860G FOREVER

UV1	UV2	IMBALLO
1	6	1/6/18 PB



8 0 3 3 2 3 7 3 3 3 3 0 8



ART	BARCODE	ST.	PREZZO
12 13 11	8033237333223		19,90

'MISS SPLENDY' ACCIAIO INOSSIDABILE 2 TAZZE 400G FOREVER

UV1	UV2	IMBALLO
1	6	1/6/36 PB



8 0 3 3 2 3 7 3 3 3 2 2 3



ART	BARCODE	ST.	PREZZO
12 13 12	8033237333247		23,50

'MISS SPLENDY' ACCIAIO INOSSIDABILE 4 TAZZE 600G FOREVER

UV1	UV2	IMBALLO
1	6	1/6/24 PB



8 0 3 3 2 3 7 3 3 3 2 4 7



ART	BARCODE	ST.	PREZZO
12 13 13	8033237333261		28,00

'MISS SPLENDY' ACCIAIO INOSSIDABILE 6 TAZZE 740G FOREVER

UV1	UV2	IMBALLO
1	6	1/6/24 PB



8 0 3 3 2 3 7 3 3 3 2 6 1



ART	BARCODE	ST.	PREZZO
12 13 14*	8033237333209		36,50

'MISS SPLENDY' ACCIAIO INOSSIDABILE
10 TAZZE 940G FOREVER

UV1	UV2	IMBALLO
1	6	1/6/18 PB



8 0 3 3 2 3 7 3 3 3 2 0 9



ART	BARCODE	ST.	PREZZO
12 15 81*	8033237333226		26,50

'MISS ORZI' ALLUMINIO 2 TAZZE 400G
FOREVER

UV1	UV2	IMBALLO
1	6	1/6/24 PB



8 0 3 3 2 3 7 3 3 3 2 2 6



ART	BARCODE	ST.	PREZZO
12 15 82*	8033237333240		35,50

'MISS ORZI' ALLUMINIO 4 TAZZE 640G
FOREVER

UV1	UV2	IMBALLO
1	3	1/6/24 PB



8 0 3 3 2 3 7 3 3 3 2 4 0



ART	BARCODE	ST.	PREZZO
12 19 01	80332373334022		34,50

'MISS DIAMOND' ACCIAIO INOSSIDABILE
2 TAZZE FOREVER

UV1	UV2	IMBALLO
1	6	1/12 PB



8 0 3 3 2 3 7 3 3 3 4 0 2 2



ART	BARCODE	ST.	PREZZO
12 19 02	80332373334046		41,00

'MISS DIAMOND' ACCIAIO INOSSIDABILE
4 TAZZE FOREVER

UV1	UV2	IMBALLO
1	6	1/12 PB



8 0 3 3 2 3 7 3 3 3 4 0 4 6



ART	BARCODE	ST.	PREZZO
12 19 03	80332373334060		46,00

'MISS DIAMOND' ACCIAIO INOSSIDABILE
6 TAZZE FOREVER

UV1	UV2	IMBALLO
1	6	1/12 PB



8 0 3 3 2 3 7 3 3 3 4 0 6 0



ART	BARCODE	ST.	PREZZO
12 19 04	80332373334008		55,00

'MISS DIAMOND' ACCIAIO INOSSIDABILE
10 TAZZE FOREVER

UV1	UV2	IMBALLO
1	6	1/6 PB



8 0 3 3 2 3 7 3 3 3 4 0 0 8



ART	BARCODE	ST.	PREZZO
12 13 77*	8033237333971	A	34,50

MISS MOKA 'INNOVA' BLACK 6 TAZZE
FOREVER

UV1	UV2	IMBALLO
1	3	1/3 PB



8 0 3 3 2 3 7 3 3 3 9 7 1



ART	BARCODE	ST.	PREZZO
12 13 72*	8033237333964	A	29,50

MISS MOKA 'INNOVA' 6 TAZZE FOREVER

UV1	UV2	IMBALLO
1	3	1/3 PB



8 0 3 3 2 3 7 3 3 3 9 6 4



ART	BARCODE	ST.	PREZZO
02 03 01	8004537203011		5,70

MOKA EVA ALLUMINIO 1/2 TAZZA 130G IN
CARTONE EVA

UV1	UV2	IMBALLO
1	18	1/18/72 PB



8 0 0 4 5 3 7 2 0 3 0 1 1



ART	BARCODE	ST.	PREZZO
02 03 02	8004537203028		6,60

MOKA EVA ALLUMINIO 1 TAZZA 170G IN
CARTONE EVA

UV1	UV2	IMBALLO
1	12	1/12/48 PB



8 0 0 4 5 3 7 2 0 3 0 2 8



ART	BARCODE	ST.	PREZZO
02 03 03	8004537203035		7,50

MOKA EVA ALLUMINIO 2 TAZZE 230G IN
CARTONE EVA

UV1	UV2	IMBALLO
1	12	1/12/48 PB



8 0 0 4 5 3 7 2 0 3 0 3 5



ART	BARCODE	ST.	PREZZO
02 03 04	8004537203042		8,20

MOKA EVA ALLUMINIO 3 TAZZE 270G IN CARTONE EVA

UV1	UV2	IMBALLO
1	6	1/6/36 PB



8 0 0 4 5 3 7 2 0 3 0 4 2



ART	BARCODE	ST.	PREZZO
02 03 05	8004537203059		11,60

MOKA EVA ALLUMINIO 6 TAZZE 390G IN CARTONE EVA

UV1	UV2	IMBALLO
1	6	1/6/36 PB



8 0 0 4 5 3 7 2 0 3 0 5 9



ART	BARCODE	ST.	PREZZO
02 03 07	8004537203073	A	22,60

MOKA EVA ALLUMINIO 12 TAZZE 740G IN CARTONE EVA

UV1	UV2	IMBALLO
1	6	1/6/18 PB



8 0 0 4 5 3 7 2 0 3 0 7 3



ART	BARCODE	ST.	PREZZO
02 03 12	8004537203127		6,50

MOKA EVA ALLUMINIO 1 TAZZA 170G FASCETTA EVA

UV1	UV2	IMBALLO
1	12	1/12/48 SL



8 0 0 4 5 3 7 2 0 3 1 2 7



ART	BARCODE	ST.	PREZZO
02 03 14	8004537203141		8,05

MOKA EVA ALLUMINIO 3 TAZZE 270G FASCETTA EVA

UV1	UV2	IMBALLO
1	6	1/6/36 SL



8 0 0 4 5 3 7 2 0 3 1 4 1



ART	BARCODE	ST.	PREZZO
02 03 15	8004537203158		11,50

MOKA EVA ALLUMINIO 6 TAZZE 390G FASCETTA EVA

UV1	UV2	IMBALLO
1	6	1/6/36 SL



8 0 0 4 5 3 7 2 0 3 1 5 8



ART	BARCODE	ST.	PREZZO
02 21 14	8004537221145		15,40

CAPPUCCINO CREAMER 3 TAZZE ACCIAIO INOSSIDABILE 0,4L EVA

UV1	UV2	IMBALLO
1	6	1/24 PB



8 0 0 4 5 3 7 2 2 1 1 4 5



ART	BARCODE	ST.	PREZZO
02 21 15	8004537221152		18,30

CAPPUCCINO CREAMER 6 TAZZE ACCIAIO INOSSIDABILE 0,8L EVA

UV1	UV2	IMBALLO
1	6	1/24 PB



8 0 0 4 5 3 7 2 2 1 1 5 2



ART	BARCODE	ST.	PREZZO
12 22 22	8033237337542		25,90

SCHIUMALATTE ACCIAIO INOSSIDABILE 0,8L FOREVER

UV1	UV2	IMBALLO
1	12	1/12 PB



8 0 3 3 2 3 7 3 3 7 5 4 2



ART	BARCODE	ST.	PREZZO
12 22 02	8033237337122	A	12,50

LATTIERA ACCIAIO INOSSIDABILE LUCIDA 600ML FOREVER

UV1	UV2	IMBALLO
1	6	1/6/48 PB



8 0 3 3 2 3 7 3 3 7 1 2 2



ART	BARCODE	ST.	PREZZO
12 22 51	8033237337191		15,30

LATTIERA "LATTEART" ACCIAIO INOSSIDABILE 350ML FOREVER

UV1	UV2	IMBALLO
1	6	1/6/48 PB



8 0 3 3 2 3 7 3 3 7 1 9 1



ART	BARCODE	ST.	PREZZO
12 22 52	8033237337207		16,60

LATTIERA "LATTEART" ACCIAIO INOSSIDABILE 550ML FOREVER

UV1	UV2	IMBALLO
1	6	1/6/48 PB



8 0 3 3 2 3 7 3 3 7 2 0 7



ART	BARCODE	ST.	PREZZO
12 22 53	8033237337214		18,90

LATTIERA "LATTEART" ACCIAIO
INOSSIDABILE 750ML FOREVER

UV1	UV2	IMBALLO
1	6	1/6/48 PB



8 0 3 3 2 3 7 3 3 7 2 1 4



ART	BARCODE	ST.	PREZZO
12 22 54	8033237337221		17,90

LATTIERA "LATTEART" NERO/ACCIAIO
INOSSIDABILE 350ML FOREVER

UV1	UV2	IMBALLO
1	6	1/6/48 PB



8 0 3 3 2 3 7 3 3 7 2 2 1



ART	BARCODE	ST.	PREZZO
12 22 55	8033237337238		19,50

LATTIERA "LATTEART" NERO/ACCIAIO
INOSSIDABILE 550ML FOREVER

UV1	UV2	IMBALLO
1	6	1/6/48 PB



8 0 3 3 2 3 7 3 3 7 2 3 8



ART	BARCODE	ST.	PREZZO
12 22 56	8033237337245		22,00

LATTIERA "LATTEART" NERO/ACCIAIO
INOSSIDABILE 750ML FOREVER

UV1	UV2	IMBALLO
1	6	1/6/48 PB



8 0 3 3 2 3 7 3 3 7 2 4 5



ART	BARCODE	ST.	PREZZO
12 22 61	8033237337252		6,50

LATTIERA ACCIAIO INOSSIDABILE
LUCIDA 150ML FOREVER

UV1	UV2	IMBALLO
1	6	1/6/48 PB



8 0 3 3 2 3 7 3 3 7 2 5 2



ART	BARCODE	ST.	PREZZO
12 22 62	8033237337269		9,30

LATTIERA ACCIAIO INOSSIDABILE
LUCIDA 350ML FOREVER

UV1	UV2	IMBALLO
1	6	1/6/48 PB



8 0 3 3 2 3 7 3 3 7 2 6 9



ART	BARCODE	ST.	PREZZO
12 22 63	8033237337276		12,10

LATTIERA ACCIAIO INOSSIDABILE
LUCIDA 600ML FOREVER

UV1	UV2	IMBALLO
1	6	1/6/48 PB



8 0 3 3 2 3 7 3 3 7 2 7 6



ART	BARCODE	ST.	PREZZO
12 22 64	8033237337283		15,90

LATTIERA ACCIAIO INOSSIDABILE
LUCIDA 900ML FOREVER

UV1	UV2	IMBALLO
1	6	1/6/48 PB



8 0 3 3 2 3 7 3 3 7 2 8 3



ART	BARCODE	ST.	PREZZO
12 22 32	8033237335579	A	8,30

SPARGICACAO ACCIAIO INOSSIDABILE
FOREVER

UV1	UV2	IMBALLO
1	6	1/6/72 PB



8 0 3 3 2 3 7 3 3 5 5 7 9



ART	BARCODE	ST.	PREZZO
12 22 33	8033237336194	A	3,50

STENCIL DECORA-CAPPUCCINO ACCIAIO
INOSSIDABILE FOREVER

UV1	UV2	IMBALLO
1	12	1/12/120 CD



8 0 3 3 2 3 7 3 3 6 1 9 4



ART	BARCODE	ST.	PREZZO
12 22 31	8033237335586	A	9,70

SPARGIZUCCHERO ACCIAIO
INOSSIDABILE FOREVER

UV1	UV2	IMBALLO
1	6	1/6/72 PB



8 0 3 3 2 3 7 3 3 5 5 8 6



ART	BARCODE	ST.	PREZZO
07 20 24	8004537720242		4,40

DOSAZUCCHERO GRANDE 'FLEUR'
VETRO 280ML

UV1	UV2	IMBALLO
1	10	1/10 BK



8 0 0 4 5 3 7 7 2 0 2 4 2



ART	BARCODE	ST.	PREZZO
07 20 46	8004537720464		4,90

DOSAZUCCHERO BOMBATO+COPERCHIO INOX 280ML

UV1	UV2	IMBALLO
1	10	1/10 BK



8 0 0 4 5 3 7 7 2 0 4 6 4



ART	BARCODE	ST.	PREZZO
07 20 15	8004537720150	A	2,95

DOSA-ZUCCHERO VETRO/ACCIAIO INOSSIDABILE 370ML EVA

UV1	UV2	IMBALLO
1	6	1/6/24 PB



8 0 0 4 5 3 7 7 2 0 1 5 0



ART	BARCODE	ST.	PREZZO
07 20 25	8004537720259		9,10

DOSAMIELE GRANDE 'FLEUR' VETRO 280ML

UV1	UV2	IMBALLO
1	10	1/10 BK



8 0 0 4 5 3 7 7 2 0 2 5 9



ART	BARCODE	ST.	PREZZO
07 20 47	8004537720471		9,30

DOSAMIELE BOMBATO+COPERCHIO INOX 280ML

UV1	UV2	IMBALLO
1	10	1/10 BK



8 0 0 4 5 3 7 7 2 0 4 7 1



ART	BARCODE	ST.	PREZZO
02 22 18	4006508200061		2,30

40 FILTRI CARTA 102 MELITTA

UV1	UV2	IMBALLO
1	18	1/18 PB



4 0 0 6 5 0 8 2 0 0 0 6 1



ART	BARCODE	ST.	PREZZO
02 22 41	4006508123094		2,00

40 FILTRI CARTA 1X2 MELITTA

UV1	UV2	IMBALLO
1	18	1/18 PB



4 0 0 6 5 0 8 1 2 3 0 9 4



ART	BARCODE	ST.	PREZZO
02 22 42	4006508200016		2,45

40 FILTRI CARTA 1X4 MELITTA

UV1	UV2	IMBALLO
1	18	1/18 PB



4 0 0 6 5 0 8 2 0 0 0 1 6



ART	BARCODE	ST.	PREZZO
02 22 43	4006508123834		3,40

40 FILTRI CARTA 1X6 MELITTA

UV1	UV2	IMBALLO
1	16	1/8 PB



4 0 0 6 5 0 8 1 2 3 8 3 4



ART	BARCODE	ST.	PREZZO
02 22 17	4006508125999		2,00

40 FILTRI CARTA 101 MELITTA

UV1	UV2	IMBALLO
1	18	1/9 PB



4 0 0 6 5 0 8 1 2 5 9 9 9



ART	BARCODE	ST.	PREZZO
02 22 55	4004094245060		18,90

FILTRO CAFFÈ' PERMANENTE 'BRASILIA' ACCIAIO INOSS. WESTMARK

UV1	UV2	IMBALLO
1	3	1/3/24 PB



4 0 0 4 0 9 4 2 4 5 0 6 0



ART	BARCODE	ST.	PREZZO
02 22 61	4004094245169		10,80

FILTRO CAFFÈ' RETE MIS. 2 'BRASILIA' ACCIAIO INOSS. WESTMARK

UV1	UV2	IMBALLO
1	3	1/3/24 HB



4 0 0 4 0 9 4 2 4 5 1 6 9



ART	BARCODE	ST.	PREZZO
02 22 62	4004094245367		13,80

FILTRO CAFFÈ' RETE MIS. 4 'BRASILIA' ACCIAIO INOSS. WESTMARK

UV1	UV2	IMBALLO
1	3	1/3/24 HB



4 0 0 4 0 9 4 2 4 5 3 6 7



ART	BARCODE	ST.	PREZZO
02 22 53	4004094244360		6,50

FITRO CAFÉ PERMANENTE MISURA 4
PP WESTMARK

UV1	UV2	IMBALLO
1	5	1/5/35 PB



4 0 0 4 0 9 4 2 4 4 3 6 0



ART	BARCODE	ST.	PREZZO
02 22 50	4004094244261		2,20

FILTRO CAFÉ 'TWO' PP NERO 1X2
WESTMARK

UV1	UV2	IMBALLO
1	12	1/12 BK



4 0 0 4 0 9 4 2 4 4 2 6 1



ART	BARCODE	ST.	PREZZO
02 22 51	4004094244469		3,10

FILTRO CAFÉ 'FOUR' PP NERO 1X4
WESTMARK

UV1	UV2	IMBALLO
1	12	1/12 BK



4 0 0 4 0 9 4 2 4 4 4 6 9



ART	BARCODE	ST.	PREZZO
02 22 52	4004094244667		4,20

FILTRO CAFÉ 'AROMA' PP NERO 1X6
WESTMARK

UV1	UV2	IMBALLO
1	12	1/6 BK



4 0 0 4 0 9 4 2 4 4 6 6 7



ART	BARCODE	ST.	PREZZO
07 61 59	8006023194940		7,95

DOSACAFFÈ "COFFEE TIME" 23X10CM
MELICONI

UV1	UV2	IMBALLO
1	6	1/6 CT



8 0 0 6 0 2 3 1 9 4 9 4 0



ART	BARCODE	ST.	PREZZO
02 19 11	8004537219111	A	22,00

MACINACAFFÈ RAME/CERAMICA Ø8,5CM
EVA

UV1	UV2	IMBALLO
1	5	1/30 PB



8 0 0 4 5 3 7 2 1 9 1 1 1



ART	BARCODE	ST.	PREZZO
12 22 35	8033237336200		20,90

MACINACAFFÈ ACCIAIO INOSSIDABILE
9.5CM FOREVER

UV1	UV2	IMBALLO
1	4	1/4/16 PB



8 0 3 3 2 3 7 3 3 6 2 0 0



ART	BARCODE	ST.	PREZZO
02 19 12	8004537219128		12,20

MACINACAFFÈ FAGGIO/CERAMICA
10,5X10,5X16CM EVA

UV1	UV2	IMBALLO
1	6	1/30 PB



8 0 0 4 5 3 7 2 1 9 1 2 8



ART	BARCODE	ST.	PREZZO
02 19 13	8004537219135		16,70

MACINACAFFÈ FAGGIO/CERAMICA
12,5X12,5X16CM EVA

UV1	UV2	IMBALLO
1	6	1/30 PB



8 0 0 4 5 3 7 2 1 9 1 3 5



ART	BARCODE	ST.	PREZZO
07 61 80	4000270382024		4,95

BARATTOLO CAFFÈ ROTONDO
Ø11X19CM KESPER

UV1	UV2	IMBALLO
1	4	1/4/24 BK



4 0 0 0 2 7 0 3 8 2 0 2 4



ART	BARCODE	ST.	PREZZO
07 61 81	4000270382055		4,95

BARATTOLO CAFFÈ RETTANGOLARE
14X8,5X19,5CM KESPER

UV1	UV2	IMBALLO
1	4	1/4/24 BK



4 0 0 0 2 7 0 3 8 2 0 5 5



ART	BARCODE	ST.	PREZZO
07 61 74	8004537761740		14,80

BARATTOLO CAFFÈ 'COFFEE MACHINE'
NERO 21X11X21CM GAWOL

UV1	UV2	IMBALLO
1	6	1/6 BK



8 0 0 4 5 3 7 7 6 1 7 4 0

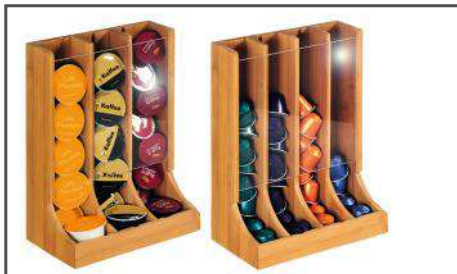

ART	BARCODE	ST.	PREZZO
04 15 49	4000270509469		22,80

**PORTACAPSULE BAMBU REGOLABILE
21X12,5X28CM KESPER**

UV1	UV2	IMBALLO
1	4	1/4 PB



4 0 0 0 2 7 0 5 0 9 4 6 9



ART	BARCODE	ST.	PREZZO
12 21 51	8033237335593		8,95

**2 BICCHIERI ESPRESSO VETRO
BOROSIL. DOPPIA PARETE 80ML FOREV**

UV1	UV2	IMBALLO
1	6	1/24 PB



8 0 3 3 2 3 7 3 3 5 5 9 3



ART	BARCODE	ST.	PREZZO
12 21 52	8033237335609		11,80

**2 BICCHIERI CAPPUCCINO VETRO
BOROS. DOPPIA PARETE 200ML FORE**

UV1	UV2	IMBALLO
1	6	1/24 PB



8 0 3 3 2 3 7 3 3 5 6 0 9



ART	BARCODE	ST.	PREZZO
12 21 53	8033237335616		15,20

**2 BICCHIERI TE'/LATTE VETRO BOROS.
DOPPIA PARETE 400ML FOREV**

UV1	UV2	IMBALLO
1	6	1/24 PB



8 0 3 3 2 3 7 3 3 5 6 1 6

Fondute Cioccolatiere Accessori



ART	BARCODE	ST.	PREZZO
07 01 61	8004537701616		110,00

SERVIZIO FONDUTA SMALTO NERO OPACO 31PZ EVA

UV1	UV2	IMBALLO
1	2	1/1 PB



8 0 0 4 5 3 7 7 0 1 6 1 6



ART	BARCODE	ST.	PREZZO
07 06 31	8004537706314		76,00

29 PEZZI SET FONDUTA SMALTATA BIANCO EVA

UV1	UV2	IMBALLO
1	2	1/2 PB



8 0 0 4 5 3 7 7 0 6 3 1 4



ART	BARCODE	ST.	PREZZO
07 01 63	8004537701630		79,50

25 PEZZI SET FONDUTA SMALTATA NERO OPACO EVA

UV1	UV2	IMBALLO
1	2	1/2 PB



8 0 0 4 5 3 7 7 0 1 6 3 0



ART	BARCODE	ST.	PREZZO
07 06 15	8004537706154		52,00

23 PEZZI SET FONDUTA SMALTATA BIANCO LUCIDO EVA

UV1	UV2	IMBALLO
1	4	1/4 PB



8 0 0 4 5 3 7 7 0 6 1 5 4



ART	BARCODE	ST.	PREZZO
07 06 17	8004537706178		56,50

23 PEZZI SET FONDUTA SMALTO ROSSO LUCIDO EVA

UV1	UV2	IMBALLO
1	4	1/4 PB



8 0 0 4 5 3 7 7 0 6 1 7 8



ART	BARCODE	ST.	PREZZO
07 06 21	8004537706215		55,00

FONDUTA SMALTO NERO OPACO 23PZ EVA

UV1	UV2	IMBALLO
1	4	1/4 PB



8 0 0 4 5 3 7 7 0 6 2 1 5



ART	BARCODE	ST.	PREZZO
07 06 10	8004537706109		34,50

FONDUTA SMALTO NERO OPACO 12PZ EVA

UV1	UV2	IMBALLO
1	6	1/6 PB



8 0 0 4 5 3 7 7 0 6 1 0 9



ART	BARCODE	ST.	PREZZO
07 06 01	8004537706017		33,00

12 PEZZI SET FONDUTA SMALTO BIANCO LUCIDO EVA

UV1	UV2	IMBALLO
1	6	1/6 PB



8 0 0 4 5 3 7 7 0 6 0 1 7



ART	BARCODE	ST.	PREZZO
07 06 04	8004537706048		36,50

12 PEZZI SET FONDUTA SMALTO ROSSO LUCIDO EVA

UV1	UV2	IMBALLO
1	6	1/6 PB



8 0 0 4 5 3 7 7 0 6 0 4 8



ART	BARCODE	ST.	PREZZO
07 02 10	8004537702101		45,00

SET FONDUTA FORMAGGIO CERAMICA ROSSO 11PZ EVA

UV1	UV2	IMBALLO
1	4	1/4 PB



8 0 0 4 5 3 7 7 0 2 1 0 1



ART	BARCODE	ST.	PREZZO
07 03 59	8004537703597		6,90

BAGNACAUDA CERAMICA BIANCA Ø11CM EVA

UV1	UV2	IMBALLO
1	6	1/24 PB



8 0 0 4 5 3 7 7 0 3 5 9 7



ART	BARCODE	ST.	PREZZO
07 03 60	8004537703603		6,90

BAGNACAUDA CERAMICA COGNAC Ø11CM EVA

UV1	UV2	IMBALLO
1	6	1/24 PB



8 0 0 4 5 3 7 7 0 3 6 0 3

Art 07 04 21



Art 07 04 19

ART	BARCODE	ST.	PREZZO
07 04 19	8004537704198		8,75

PIATTO FONDUTA NERO OPACO Ø22CM EVA

UV1	UV2	IMBALLO
6	24	1/6/24 BK



8 0 0 4 5 3 7 7 0 4 1 9 8

Art 07 04 21



Art 07 04 19

ART	BARCODE	ST.	PREZZO
07 04 21	8004537704211		8,75

PIATTO FONDUTA BIANCO LUCIDO Ø22CM EVA

UV1	UV2	IMBALLO
6	12	1/6/24 BK



8 0 0 4 5 3 7 7 0 4 2 1 1



ART	BARCODE	ST.	PREZZO
07 04 99	8004537704990		3,80

COPPETTA FONDUTA BIANCO LUCIDO TIPO A Ø9CM EVA

UV1	UV2	IMBALLO
6	12	1/6/60 BK



8 0 0 4 5 3 7 7 0 4 9 9 0



ART	BARCODE	ST.	PREZZO
07 04 74	8004537704747	H	2,20

COPPETTA FONDUTA BIANCO TIPO E Ø9,5CM EVA

UV1	UV2	IMBALLO
6	12	1/6/72 BK



8 0 0 4 5 3 7 7 0 4 7 4 7



ART	BARCODE	ST.	PREZZO
07 04 89	8004537704891		3,80

COPPETTA FONDUTA NERO OPACO TIPO D Ø10CM EVA

UV1	UV2	IMBALLO
6	12	1/6/60 BK



8 0 0 4 5 3 7 7 0 4 8 9 1



ART	BARCODE	ST.	PREZZO
07 03 62	8004537703627		4,90

6 FORCHETTE FONDUTA LEGNO SCURO EVA

UV1	UV2	IMBALLO
1	12	1/12/72 HB



8 0 0 4 5 3 7 7 0 3 6 2 7



ART	BARCODE	ST.	PREZZO
07 03 66	8004537703665		4,90

6 FORCHETTE FONDUTA LEGNO NATURALE EVA

UV1	UV2	IMBALLO
1	12	1/12/72 BC



8 0 0 4 5 3 7 7 0 3 6 6 5



ART	BARCODE	ST.	PREZZO
07 03 69	8004537703696		4,90

6 FORCHETTE FONDUTA LEGNO RUSTICA EVA

UV1	UV2	IMBALLO
1	12	1/12/72 BC



8 0 0 4 5 3 7 7 0 3 6 9 6



ART	BARCODE	ST.	PREZZO
07 03 79	8004537703795	H	4,50

6 MESTOLINI FONDUTA LEGNO SCURO EVA

UV1	UV2	IMBALLO
1	12	1/24/144 PH



8 0 0 4 5 3 7 7 0 3 7 9 5



ART	BARCODE	ST.	PREZZO
07 03 89	8004537703894	H	7,50

6 MESTOLINI FONDUTA LEGNO NATURALE/ACCIAIO INOSSIDABILE EVA

UV1	UV2	IMBALLO
1	12	1/12/48 HB



8 0 0 4 5 3 7 7 0 3 8 9 4



ART	BARCODE	ST.	PREZZO
02 27 02	4008495301790		11,90

20 LUMINI MAXI 60MM

UV1	UV2	IMBALLO
1	8	1/16 SP



4 0 0 8 4 9 5 3 0 1 7 9 0



ART	BARCODE	ST.	PREZZO
02 27 03	4008495300007		1,80

10 LUMINI 38M

UV1	UV2	IMBALLO
1	30	1/30 WB



4 0 0 8 4 9 5 3 0 0 0 0 7



ART	BARCODE	ST.	PREZZO
02 27 28	8719202117974		7,25

100 LUMINI Ø35 MM

UV1	UV2	IMBALLO
1	5	1/10 PG



8 7 1 9 2 0 2 1 1 7 9 7 4



ART	BARCODE	ST.	PREZZO
07 03 92	8004537703924		6,50

FORNELLINO CROMATO+PASTA 80GR
EVA

UV1	UV2	IMBALLO
1	6	1/36 BC



8 0 0 4 5 3 7 7 0 3 9 2 4



ART	BARCODE	ST.	PREZZO
07 03 97	8004537703979		5,50

PASTA COMBUSTIBILE 'FIREBLITZ'
BOTTIGLIA 1L EVA

UV1	UV2	IMBALLO
1	6	1/12 BK



8 0 0 4 5 3 7 7 0 3 9 7 9



ART	BARCODE	ST.	PREZZO
07 03 96	8004537703962		2,95

3 PASTA COMBUSTIBILE 'FIREBLITZ' 80G
EVA

UV1	UV2	IMBALLO
1	12	1/12 HB



8 0 0 4 5 3 7 7 0 3 9 6 2



ART	BARCODE	ST.	PREZZO
07 03 99	8004537703993		1,05

PASTA COMBUSTIBILE 'FIREBLITZ' 200G
3H EVA

UV1	UV2	IMBALLO
1	24	1/72 BK



8 0 0 4 5 3 7 7 0 3 9 9 3



ART	BARCODE	ST.	PREZZO
07 03 91	8004537703917		1,45

LIQUIDO COMBUSTIBILE CHAFING DISH
'FIREBLITZ' 200G EVA

UV1	UV2	IMBALLO
1	24	1/24 BK



8 0 0 4 5 3 7 7 0 3 9 1 7



ART	BARCODE	ST.	PREZZO
07 04 02	8004537704020		15,50

PASTA COMBUSTIBILE 'FIREBLITZ'
TANICA 5L EVA

UV1	UV2	IMBALLO
1	3	1/3 AL



8 0 0 4 5 3 7 7 0 4 0 2 0



ART	BARCODE	ST.	PREZZO
07 04 03	8004537704037		15,50

PASTA COMBUSTIBILE 'FIREBLITZ'
SECCHIO 5L EVA

UV1	UV2	IMBALLO
1	3	1/3 BK



8 0 0 4 5 3 7 7 0 4 0 3 7



ART	BARCODE	ST.	PREZZO
07 04 08	4039881641084		16,50

EROGATORE PER PASTA COMBUSTIBILE
'FIRESTAR' PANODIS

UV1	UV2	IMBALLO
1	2	1/10 BK



4 0 3 9 8 8 1 6 4 1 0 8 4

Aceto Olio Sale Pepe Spezie



ART	BARCODE	ST.	PREZZO
04 17 92	8004537417920		18,50

5 PEZZI MENAGE 'POSITANO' ACCIAIO INOSSIDABILE EVA

UV1	UV2	IMBALLO
1	5	1/20 PB



8 0 0 4 5 3 7 4 1 7 9 2 0



ART	BARCODE	ST.	PREZZO
04 17 93	8004537417937		12,50

FORMAGGIERA+CUCCHIAIO 'POSITANO' ACCIAIO INOSSIDABILE EVA

UV1	UV2	IMBALLO
1	6	1/24 PB



8 0 0 4 5 3 7 4 1 7 9 3 7



ART	BARCODE	ST.	PREZZO
04 18 54	8004537418545		5,95

2 PEZZI MENAGE SALE+PEPE 'AMALFI' ACCIAIO INOSSID. 18/8 EVA

UV1	UV2	IMBALLO
1	12	1/60 PB



8 0 0 4 5 3 7 4 1 8 5 4 5



ART	BARCODE	ST.	PREZZO
04 18 56	8004537418569		7,80

3 PEZZI MENAGE SALE+PEPE 'AMALFI' ACCIAIO INOSSID. 18/8 EVA

UV1	UV2	IMBALLO
1	8	1/48 PB



8 0 0 4 5 3 7 4 1 8 5 6 9



ART	BARCODE	ST.	PREZZO
04 18 49	8004537418491		17,50

5 PEZZI MENAGE 'AMALFI' ACCIAIO INOSSIDABILE 18/8 EVA

UV1	UV2	IMBALLO
1	10	1/20 PB



8 0 0 4 5 3 7 4 1 8 4 9 1



ART	BARCODE	ST.	PREZZO
04 18 48	8004537418484		9,70

4 PZ MENAGE ACCIAIO INOSSIDABILE 18/8 'SORRENTO' EVA

UV1	UV2	IMBALLO
1	6	1/6/24 PB



8 0 0 4 5 3 7 4 1 8 4 8 4



ART	BARCODE	ST.	PREZZO
04 18 46	8004537418460		2,65

SPARGI-FORMAGGIO VETRO/ACCIAIO INOSSIDABILE 370ML EVA

UV1	UV2	IMBALLO
1	6	1/6/24 PB



8 0 0 4 5 3 7 4 1 8 4 6 0



ART	BARCODE	ST.	PREZZO
04 18 45	8004537418453		8,50

FORMAGGIERA+CUCCHIAIO 'SORRENTO' EVA

UV1	UV2	IMBALLO
1	12	1/12/48 PB



8 0 0 4 5 3 7 4 1 8 4 5 3



ART	BARCODE	ST.	PREZZO
07 24 20	4004094695766		22,40

MACININO PER NOCE MOSCATA ABS/SAN/INOX WESTMARK

UV1	UV2	IMBALLO
1	4	1/4/36 PB



4 0 0 4 0 9 4 6 9 5 7 6 6



ART	BARCODE	ST.	PREZZO
04 32 70*	8004537432701	H	12,50

3 PEZZI MENAGE SALE PEPE STUZZICADENTI FAGGIO KGZ

UV1	UV2	IMBALLO
1	6	1/10 SP



8 0 0 4 5 3 7 4 3 2 7 0 1



ART	BARCODE	ST.	PREZZO
07 25 13	4000270580970	A	19,30

7 PEZZI MENAGE SPEZIE BAMBU FSC+VASETTI VUOTI KESPER

UV1	UV2	IMBALLO
1	2	1/2 SP



4 0 0 0 2 7 0 5 8 0 9 7 0



ART	BARCODE	ST.	PREZZO
07 25 14	4000270580994		27,50

9 PEZZI PORTASPEZIE GIREVOLE BAMBU' FSC SENZA SPEZIE KESPER

UV1	UV2	IMBALLO
1	2	1/2 SP



4 0 0 0 2 7 0 5 8 0 9 9 4



ART	BARCODE	ST.	PREZZO
07 25 20	400270130106		1,40

RICAMBIO VASETTO PORTASPEZIE VETRO MARRONE KESPER

UV1	UV2	IMBALLO
1	6	1/60 BK



4 0 0 0 2 7 0 1 3 0 1 0 6



ART	BARCODE	ST.	PREZZO
09 21 35	8004537921359		1,40

PORTASPEZIE ROTONDO VETRO IN DISPLAY EVA

UV1	UV2	IMBALLO
12	96	1/12/96 DB



8 0 0 4 5 3 7 9 2 1 3 5 9



ART	BARCODE	ST.	PREZZO
07 20 29	8004537720297		5,80

2 SPARGISALE/PEPE 'FLEUR' VETRO 50 ML

UV1	UV2	IMBALLO
1	10	1/10/80 AB



8 0 0 4 5 3 7 7 2 0 2 9 7



ART	BARCODE	ST.	PREZZO
07 20 43	8004537720433		5,60

3 SPARGISALE/PEPE BOMBATO+COPERCHIO ACCIAIO INOSSID. 5 ML

UV1	UV2	IMBALLO
1	18	1/6/144 AB



8 0 0 4 5 3 7 7 2 0 4 3 3



ART	BARCODE	ST.	PREZZO
07 20 06	4004094630514		1,80

SPARGISALE/PEPE PARIS VETRO/PP IN DISPLAY WESTMARK

UV1	UV2	IMBALLO
15	45	1/15/60 DB



4 0 0 4 0 9 4 6 3 0 5 1 4



ART	BARCODE	ST.	PREZZO
07 24 64	4004094635267		8,05

MACINO UNIVERSALE 'ACRYLIC' PC/CERAMICA IN DISPLAY WESTMARK

UV1	UV2	IMBALLO
12	24	1/12/48 DB



4 0 0 4 0 9 4 6 3 5 2 6 7



ART	BARCODE	ST.	PREZZO
07 24 65	4004094635465		7,75

MACINA SPEZIE VETRO/PS/PP/CERAMICA 13 CM WESTMARK

UV1	UV2	IMBALLO
1	6	1/6/48 PB



4 0 0 4 0 9 4 6 3 5 4 6 5



ART	BARCODE	ST.	PREZZO
07 24 29	8004537724295		8,40

MACINAPEPE ROTORE ACRILICO MACININO IN CERAMICA 13CM EVA

UV1	UV2	IMBALLO
1	6	1/12/48 AB



8 0 0 4 5 3 7 7 2 4 2 9 5



ART	BARCODE	ST.	PREZZO
07 24 13	8004537724134		7,30

MACINAPEPE ACRILICO MACININO IN CERAMICA 14CM EVA

UV1	UV2	IMBALLO
1	6	1/12/48 AB



8 0 0 4 5 3 7 7 2 4 1 3 4



ART	BARCODE	ST.	PREZZO
07 24 14	8004537724141		7,70

MACINAPEPE ACRILICO MACININO IN CERAMICA 16,5CM EVA

UV1	UV2	IMBALLO
1	6	1/12/48 PV



8 0 0 4 5 3 7 7 2 4 1 4 1



ART	BARCODE	ST.	PREZZO
07 24 15	8004537724158		9,80

MACINAPEPE ACRILICO MACININO IN CERAMICA 21CM EVA

UV1	UV2	IMBALLO
1	6	1/12/36 AB



8 0 0 4 5 3 7 7 2 4 1 5 8



ART	BARCODE	ST.	PREZZO
07 24 16	8004537724165		11,25

MACINAPEPE ACRILICO MACININO IN CERAMICA 26CM EVA

UV1	UV2	IMBALLO
1	6	1/12/24 AB



8 0 0 4 5 3 7 7 2 4 1 6 5



ART	BARCODE	ST.	PREZZO
07 24 01	4019889136638		10,90

MACINA PEPE "TANGO" MACINA IN CERAMICA 18 CM LURCH

UV1	UV2	IMBALLO
1	6	1/6/48 PG



4 0 1 9 8 8 9 1 3 6 6 3 8



ART	BARCODE	ST.	PREZZO
07 24 02	4019889136645		10,90

MACINA SALE "TANGO" MACINA IN CERAMICA 18 CM LURCH

UV1	UV2	IMBALLO
1	6	1/6/48 PG



4 0 1 9 8 8 9 1 3 6 6 4 5



ART	BARCODE	ST.	PREZZO
07 24 03	4019889136652		10,90

MACINA NOCE MOSCATA "TANGO" MACINA ACCIAIO INOSS 13 CM LURCH

UV1	UV2	IMBALLO
1	6	1/6/48 PG



4 0 1 9 8 8 9 1 3 6 6 5 2



ART	BARCODE	ST.	PREZZO
07 24 04	4019889136669		10,90

MACINA PEPERONCINO/CIOCCOL "TANGO" MACINA ACCIAIO INOSS 18CM

UV1	UV2	IMBALLO
1	6	1/6/48 PG



4 0 1 9 8 8 9 1 3 6 6 6 9



ART	BARCODE	ST.	PREZZO
07 24 37	4000270136603		7,00

MACINAPEPE IN LEGNO MACINA CERAMICA Ø 5 - H 16,5 CM KESPER

UV1	UV2	IMBALLO
1	3	1/3/96 HT



4 0 0 0 2 7 0 1 3 6 6 0 3



ART	BARCODE	ST.	PREZZO
07 24 38	4000270136610		9,00

MACINAPEPE IN LEGNO MACINA CERAMICA Ø 5,5 - H 22 CM KESPER

UV1	UV2	IMBALLO
1	3	1/3/72 HT



4 0 0 0 2 7 0 1 3 6 6 1 0



ART	BARCODE	ST.	PREZZO
07 24 39	4000270136627		10,50

MACINAPEPE IN LEGNO MACINA CERAMICA Ø 6 - H 26,5 CM KESPER

UV1	UV2	IMBALLO
1	3	1/3/48 HT



4 0 0 0 2 7 0 1 3 6 6 2 7



ART	BARCODE	ST.	PREZZO
07 24 22	4000270139109		8,90

MACINA-PEPERONCINO VETRO/ACCIAIO INOSSIDAB 6,5X15,5CM KESPER

UV1	UV2	IMBALLO
1	5	1/5/50 AB



4 0 0 0 2 7 0 1 3 9 1 0 9



ART	BARCODE	ST.	PREZZO
07 24 35	4000270137105		17,50

MACINAPEPE ELETTRICO ACCIAIO INOSSIDABILE H 20,5CM KESPER

UV1	UV2	IMBALLO
1	3	1/3/24 AB



4 0 0 0 2 7 0 1 3 7 1 0 5



ART	BARCODE	ST.	PREZZO
04 18 62	8004537418620		37,50

OLIERA ACCIAIO INOSSIDABILE 18/8 0,5 L EVA

UV1	UV2	IMBALLO
1	4	1/4/16 PB



8 0 0 4 5 3 7 4 1 8 6 2 0



ART	BARCODE	ST.	PREZZO
04 18 64	8004537418644		10,50

OLIERA ACCIAIO INOSSIDABILE 0,4L - Ø 7,5 x 13 CM EVA

UV1	UV2	IMBALLO
1	6	1/6/60 PB



8 0 0 4 5 3 7 4 1 8 6 4 4



ART	BARCODE	ST.	PREZZO
04 18 65	8004537418651		12,00

OLIERA ACCIAIO INOSSIDABILE 0,70L - Ø 9 X 15,5 CM EVA

UV1	UV2	IMBALLO
1	6	1/6/48 PB



8 0 0 4 5 3 7 4 1 8 6 5 1



ART	BARCODE	ST.	PREZZO
04 18 66	8004537418668		14,90

OLIERA ACCIAIO INOSSIDABILE 1,2L - Ø 11CM EVA

UV1	UV2	IMBALLO
1	6	1/6/48 PB



8 0 0 4 5 3 7 4 1 8 6 6 8



ART	BARCODE	ST.	PREZZO
04 17 87	8004537417876		12,90

OLIERA DECORATA OVALE ACCIAIO INOSSIDABILE 0,5L EVA

UV1	UV2	IMBALLO
1	12	1/24 PB



8 0 0 4 5 3 7 4 1 7 8 7 6



ART	BARCODE	ST.	PREZZO
04 17 88	8004537417883		12,90

OLIERA DECORATA RETTANGOLARE ACCIAIO INOSSIDABILE 0,5L EVA

UV1	UV2	IMBALLO
1	12	1/24 PB



8 0 0 4 5 3 7 4 1 7 8 8 3



ART	BARCODE	ST.	PREZZO
04 18 31	8004537418316		14,20

OLIERA DECORATA OVALE ACCIAIO INOSSIDABILE 0,5L EVA

UV1	UV2	IMBALLO
1	12	1/24 PB



8 0 0 4 5 3 7 4 1 8 3 1 6



ART	BARCODE	ST.	PREZZO
09 21 39	8004537921397		1,95

OLIERA VETRO DECORATO 270ML IN DISPLAY EVA

UV1	UV2	IMBALLO
12	48	1/12/48 DB



8 0 0 4 5 3 7 9 2 1 3 9 7



ART	BARCODE	ST.	PREZZO
09 21 40	8004537912401		2,55

OLIERA VETR DECORATO 500ML EVA IN DISPLAY

UV1	UV2	IMBALLO
12	24	1/12/24 DB



8 0 0 4 5 3 7 9 1 2 4 0 1



ART	BARCODE	ST.	PREZZO
04 18 87	8004537418873		9,95

OLIERA+VERSATORE ACRILICO 0,25L EVA

UV1	UV2	IMBALLO
1	6	1/24 PB



8 0 0 4 5 3 7 4 1 8 8 7 3



ART	BARCODE	ST.	PREZZO
07 20 70	4004094243660		18,00

SET SPRUZZATORE ACETO/OLIO VETRO/ACCIAIO INOSSIDAB. WESTMARK

UV1	UV2	IMBALLO
1	6	1/6/36 PB



4 0 0 4 0 9 4 2 4 3 6 6 0



ART	BARCODE	ST.	PREZZO
04 18 33	7611264810033		13,40

OLIERA VETRO CON SPRUZZATORE 'SPICY' MOHA

UV1	UV2	IMBALLO
1	6	1/6/48 HB



7 6 1 1 2 6 4 8 1 0 0 3 3



ART	BARCODE	ST.	PREZZO
09 13 09	8004537913095		7,25

OLIERA CONICA VETRO BOROSILICATO 250 ML EVA

UV1	UV2	IMBALLO
1	6	1/24 PB



8 0 0 4 5 3 7 9 1 3 0 9 5



ART	BARCODE	ST.	PREZZO
09 13 10	8004537913101		10,50

OLIERA CONICA VETRO BOROSILICATO 500 ML EVA

UV1	UV2	IMBALLO
1	6	1/24 PB



8 0 0 4 5 3 7 9 1 3 1 0 1



ART	BARCODE	ST.	PREZZO
09 13 13	8004537913132		7,25

OLIERA ROTONDA VETRO BOROSILICATO 250 ML EVA

UV1	UV2	IMBALLO
1	6	1/24 PB



8 0 0 4 5 3 7 9 1 3 1 3 2



ART	BARCODE	ST.	PREZZO
09 13 14	8004537913149		10,50

OLIERA ROTONDA VETRO
BOROSILICATO 500 ML EVA

UV1	UV2	IMBALLO
1	6	1/24 PB



8 0 0 4 5 3 7 9 1 3 1 4 9



ART	BARCODE	ST.	PREZZO
09 13 17	8004537913170		7,60

OLIERA QUADRA VETRO BOROSILICATO
250 ML EVA

UV1	UV2	IMBALLO
1	6	1/24 PB



8 0 0 4 5 3 7 9 1 3 1 7 0



ART	BARCODE	ST.	PREZZO
09 13 18	8004537913187		10,70

OLIERA QUADRA VETRO BOROSILICATO
500 ML EVA

UV1	UV2	IMBALLO
1	6	1/24 PB



8 0 0 4 5 3 7 9 1 3 1 8 7



ART	BARCODE	ST.	PREZZO
09 19 57	8435011103419		6,10

OLIERA VETRO+TAPPO SUGHERO 250 CC

UV1	UV2	IMBALLO
1	6	1/6 BK



8 4 3 5 0 1 1 1 0 3 4 1 9



ART	BARCODE	ST.	PREZZO
09 19 58	8435011103433		7,20

OLIERA VETRO+TAPPO SUGHERO 500 CC

UV1	UV2	IMBALLO
1	6	1/6 BK



8 4 3 5 0 1 1 1 0 3 4 3 3



ART	BARCODE	ST.	PREZZO
09 19 59	8435011130675	A	12,00

OLIERA VETRO+TAPPO SUGHERO 1000
CC

UV1	UV2	IMBALLO
1	6	1/6 BK



8 4 3 5 0 1 1 1 3 0 6 7 5



ART	BARCODE	ST.	PREZZO
04 61 02	4004094420085		3,40

2 TAPPI VERSATORI SUGHERO CLASSIC
STANDARD 4200 WESTMARK

UV1	UV2	IMBALLO
1	10	1/5/70 BC



4 0 0 4 0 9 4 4 2 0 0 8 5



ART	BARCODE	ST.	PREZZO
04 61 04	4004094425080		4,90

2 TAPPI VERSATORI SUGHERO CLASSIC
STANDARD 4250 WESTMARK

UV1	UV2	IMBALLO
1	10	1/5/70 BC



4 0 0 4 0 9 4 4 2 5 0 8 0



ART	BARCODE	ST.	PREZZO
04 61 25	4004094451003		2,40

TAPPO VERSATORE SUGHERO
STANDARD 4510 IN DISPLAY WESTMARK

UV1	UV2	IMBALLO
12	24	1/12/240 DB



4 0 0 4 0 9 4 4 5 1 0 0 3



ART	BARCODE	ST.	PREZZO
04 61 29	4004094453007		2,55

TAPPO VERSATORE SUGHERO
STANDARD 4530 IN DISPLAY WESTMARK

UV1	UV2	IMBALLO
12	24	1/12/240 DB



4 0 0 4 0 9 4 4 5 3 0 0 7



ART	BARCODE	ST.	PREZZO
04 61 28	4004094455001		2,90

TAPPO VERSATORE SUGHERO STAND
4550 IN DISPLAY WESTMARK

UV1	UV2	IMBALLO
12	24	1/12/240 DB



4 0 0 4 0 9 4 4 5 5 0 0 1



ART	BARCODE	ST.	PREZZO
04 61 11	4004094439087		5,65

2 TAPPI VERSATORI SUGHERO CLASSIC
GASTRO 4390 WESTMARK

UV1	UV2	IMBALLO
1	10	1/5/70 BC



4 0 0 4 0 9 4 4 3 9 0 8 7



ART	BARCODE	ST.	PREZZO
04 61 27	4004094468001		2,90

TAPPO VERSATORE SUGHERO GASTRO 4680 IN DISPLAY WESTMARK

UV1	UV2	IMBALLO
12	24	1/12/240 DB



4 0 0 4 0 9 4 4 6 8 0 0 1



ART	BARCODE	ST.	PREZZO
04 61 08	4004094425288		3,95

2 TAPPI VERSATORI PE CLASSIC STANDARD 4252 WESTMARK

UV1	UV2	IMBALLO
1	10	1/5/70 BC



4 0 0 4 0 9 4 4 2 5 2 8 8



ART	BARCODE	ST.	PREZZO
04 61 49	4004094473081		7,85

2 TAPPI VERSATORI SILICONE INOX GASTRO 4730 WESTMARK

UV1	UV2	IMBALLO
1	10	1/10/70 BC



4 0 0 4 0 9 4 4 7 3 0 8 1



ART	BARCODE	ST.	PREZZO
04 61 47	4004094473289		6,50

2 TAPPI VERSATORI PROFI INOX GASTRO 4732 WESTMARK

UV1	UV2	IMBALLO
1	10	1/5/60 BC



4 0 0 4 0 9 4 4 7 3 2 8 9



ART	BARCODE	ST.	PREZZO
04 61 48	4004094473203		3,00

TAPPI VERS. SILIC.PROFI INOX GASTRO 4732 IN DISPLAY WESTMARK

UV1	UV2	IMBALLO
12	24	1/12/240 DB



4 0 0 4 0 9 4 4 7 3 2 0 3



ART	BARCODE	ST.	PREZZO
04 07 90	8004537407907		2,95

2 VERSATORE ACCIAIO INOSSIDABILE/PVC EVA

UV1	UV2	IMBALLO
1	12	1/12/288 DC



8 0 0 4 5 3 7 4 0 7 9 0 7



ART	BARCODE	ST.	PREZZO
04 61 26	4004094453304		3,05

TAPPO VERSATORE SILICONE STANDARD 4533 IN DISPLAY WESTMARK

UV1	UV2	IMBALLO
12	24	1/12/240 DB



4 0 0 4 0 9 4 4 5 3 3 0 4



ART	BARCODE	ST.	PREZZO
04 61 33	4004094455384		7,60

2 TAPPI VERSATORI +COP. SILICONE INOX STANDARD 4553 WESTMARK

UV1	UV2	IMBALLO
1	10	1/10/70 BC



4 0 0 4 0 9 4 4 5 5 3 8 4



ART	BARCODE	ST.	PREZZO
04 61 34	4004094455308		3,60

TAPPI VERS.+COP.SILIC.INOX STANDARD 4553 IN DISPLAY WESTMARK

UV1	UV2	IMBALLO
12	24	1/12/240 DB



4 0 0 4 0 9 4 4 5 5 3 0 8



ART	BARCODE	ST.	PREZZO
04 61 44	4004094467301		3,10

TAPPI VERS. SILICONE INOX GASTRO 4673 IN DISPLAY WESTMARK

UV1	UV2	IMBALLO
12	24	1/12/240 DB



4 0 0 4 0 9 4 4 6 7 3 0 1



ART	BARCODE	ST.	PREZZO
04 61 45	4004094468322		7,80

2 TAPPI VERSATORI + COP. SILICONE INOX GASTRO 4683 WESTMARK

UV1	UV2	IMBALLO
1	10	1/5/70 BC



4 0 0 4 0 9 4 4 6 8 3 2 2



ART	BARCODE	ST.	PREZZO
04 61 65	4004094478383		4,90

TAPPI VERS.+ COP. SILICONE INOX OLIO SPEZIAL 4783 WESTMARK

UV1	UV2	IMBALLO
1	10	1/5/100 BC



4 0 0 4 0 9 4 4 7 8 3 8 3



ART	BARCODE	ST.	PREZZO
04 61 66	4004094478307		4,10

TAPPI VERS.+COP.SILIC.INOX OLIO
SPEZIAL 4783 DISPLAY WESTMAR

UV1	UV2	IMBALLO
12	24	1/12/240 DB



4 0 0 4 0 9 4 4 7 8 3 0 7



ART	BARCODE	ST.	PREZZO
04 61 75	4004094479380		4,90

TAPPO VERS.+COP.SILICONE INOX
ACETO SPEZIAL 4793 WESTMARK

UV1	UV2	IMBALLO
1	10	1/5/100 BC



4 0 0 4 0 9 4 4 7 9 3 8 0



ART	BARCODE	ST.	PREZZO
04 61 76	4004094479304		4,10

TAPPO VERS.+COP.SILIC.INOX ACETO
SPEZIAL 4793 DISPLAY WESTMA

UV1	UV2	IMBALLO
12	24	1/12/240 DB



4 0 0 4 0 9 4 4 7 9 3 0 4



ART	BARCODE	ST.	PREZZO
04 61 46	4004094468308		3,50

TAPPI VERS.+COP. SILIC. INOX GASTRO
4683 IN DISPLAY WESTMARK

UV1	UV2	IMBALLO
12	24	1/12/240 DB



4 0 0 4 0 9 4 4 6 8 3 0 8



ART	BARCODE	ST.	PREZZO
04 61 53	4004094453786		3,50

2 TAPPI VERSATORI + COPERCHIO PE
INOX ECO-POUR 4537 WESTMARK

UV1	UV2	IMBALLO
1	10	1/5/70 BC



4 0 0 4 0 9 4 4 5 3 7 8 6



ART	BARCODE	ST.	PREZZO
04 61 55	4004094455780		4,00

2 TAPPI VERSATORI + COP. PE INOX ECO-
POUR 4557 WESTMARK

UV1	UV2	IMBALLO
1	10	1/5/70 BC



4 0 0 4 0 9 4 4 5 5 7 8 0



ART	BARCODE	ST.	PREZZO
04 61 56	4004094455704		1,75

TAPPI VERS.+COP. PE INOX ECO-POUR
4557 IN DISPLAY WESTMARK

UV1	UV2	IMBALLO
12	24	1/12/240 DB



4 0 0 4 0 9 4 4 5 5 7 0 4



ART	BARCODE	ST.	PREZZO
04 61 57	4004094467783		4,40

2 TAPPI VERSATORI PE INOX ECO-POUR
4677 WESTMARK

UV1	UV2	IMBALLO
1	10	1/5/70 BC



4 0 0 4 0 9 4 4 6 7 7 8 3

Vino Bar Versatori



ART	BARCODE	ST.	PREZZO
02 12 18*	9002539038012		65,00

SIFONE SELTZ INOX 1,0L KAYSER

UV1	UV2	IMBALLO
1	3	1/6 PB



9 0 0 2 5 3 9 0 3 8 0 1 2



ART	BARCODE	ST.	PREZZO
02 12 12*	9002539011015		5,95

10 CAPSULE SELTZ KAYSER

UV1	UV2	IMBALLO
1	30	1/30 PB



9 0 0 2 5 3 9 0 1 1 0 1 5



ART	BARCODE	ST.	PREZZO
04 07 35	7611264605066		4,80

PINZA CHAMPANGE / SVITA-TAPPI "TWISTY" PP NERO MOHA

UV1	UV2	IMBALLO
1	12	1/12/120 CD



7 6 1 1 2 6 4 6 0 5 0 6 6



ART	BARCODE	ST.	PREZZO
04 02 75	4004094629686	A	16,90

TAGLIACAPSULE MONDO' SATINATO WESTMARK MONOPOL EDITION

UV1	UV2	IMBALLO
1	2	1/4 PB



4 0 0 4 0 9 4 6 2 9 6 8 6



ART	BARCODE	ST.	PREZZO
04 02 72	4004094616082		55,00

LEVATAPPI A LEVA 'FINO' SATINATO WESTMARK MONOPOL EDITION

UV1	UV2	IMBALLO
1	2	1/10 PB



4 0 0 4 0 9 4 6 1 6 0 8 2



ART	BARCODE	ST.	PREZZO
04 02 83	4004094615566		28,95

LEVATAPPI A LEVA 'PEDRO' CROMATO SPIRALE TAGLIENTE WESTMARK

UV1	UV2	IMBALLO
1	2	1/10 HB



4 0 0 4 0 9 4 6 1 5 5 6 6



ART	BARCODE	ST.	PREZZO
04 07 24	8008636002124		6,65

LEVATAPPI A LEVA CROMATO GHIDINI

UV1	UV2	IMBALLO
1	12	1/12/72 CD



8 0 0 8 6 3 6 0 0 2 1 2 4



ART	BARCODE	ST.	PREZZO
04 43 22	8004537443226		8,40

LEVATAPPI A LEVA CROMATO EVA

UV1	UV2	IMBALLO
1	6	1/6/60 DC



8 0 0 4 5 3 7 4 4 3 2 2 6



ART	BARCODE	ST.	PREZZO
04 43 29	8004537443295		5,40

LEVATAPPI A LEVA GHISA EVA

UV1	UV2	IMBALLO
1	11	1/44 CD



8 0 0 4 5 3 7 4 4 3 2 9 5



ART	BARCODE	ST.	PREZZO
04 02 81	4004094625589		27,90

LEVATAPPI A CAMPANA 'CHIANTI' SATINATO WESTMARK MONOPOL ED.

UV1	UV2	IMBALLO
1	2	1/10 PB



4 0 0 4 0 9 4 6 2 5 5 8 9



ART	BARCODE	ST.	PREZZO
04 02 82	4004094626081		38,70

LEVATAPPI A CAMPANA 'BAROLO' SATINATO WESTMARK MONOPOL ED.

UV1	UV2	IMBALLO
1	2	1/10 PB



4 0 0 4 0 9 4 6 2 6 0 8 1



ART	BARCODE	ST.	PREZZO
04 02 87	4004094601460		15,80

LEVATAPPI DA CAMERIERE 'AGIOL' WESTMARK MONOPOL EDITION

UV1	UV2	IMBALLO
1	3	1/3/60 HB



4 0 0 4 0 9 4 6 0 1 4 6 0



ART	BARCODE	ST.	PREZZO
04 43 26	8004537443264		2,10

LEVATAPPI CAMERIERE 3 USI EVA

UV1	UV2	IMBALLO
1	12	1/12/120 CD



8 0 0 4 5 3 7 4 4 3 2 6 4



ART	BARCODE	ST.	PREZZO
04 07 29	8008636050071		6,80

LEVATAPPI CAMERIERE 'BOOMERANG X.TEND' GHIDINI

UV1	UV2	IMBALLO
1	12	1/12/72 CD



8 0 0 8 6 3 6 0 5 0 0 7 1



ART	BARCODE	ST.	PREZZO
04 43 01	8001237456259		1,80

LEVATAPPI CAMERIERE DOPPIA LEVA NERO EVA

UV1	UV2	IMBALLO
12	144	1/12/144 PG



8 0 0 1 2 3 7 4 5 6 2 5 9



ART	BARCODE	ST.	PREZZO
04 43 30	8004537443302		2,55

LEVATAPPI CAMERIERE ACCIAIO INOSSIDABILE/NERO EVA

UV1	UV2	IMBALLO
1	12	1/12/96 CD



8 0 0 4 5 3 7 4 4 3 3 0 2



ART	BARCODE	ST.	PREZZO
04 07 26	8008636036372	A	7,10

LEVATAPPI DA CAMERIERE 'EASYPRO' GHIDINI

UV1	UV2	IMBALLO
1	12	1/6/36 BC



8 0 0 8 6 3 6 0 3 6 3 7 2



ART	BARCODE	ST.	PREZZO
04 07 22	8004537407228	H	2,70

LEVATAPPI CAMERIERE ACCIAIO INOSSIDABILE EVA

UV1	UV2	IMBALLO
1	12	1/12/144 BC



8 0 0 4 5 3 7 4 0 7 2 2 8



ART	BARCODE	ST.	PREZZO
04 43 27	8004537443271		2,85

LEVATAPPI CAMERIERE DOPPIA LEVA INOX ANTIADERENTE EVA

UV1	UV2	IMBALLO
1	12	1/12/96 CD



8 0 0 4 5 3 7 4 4 3 2 7 1



ART	BARCODE	ST.	PREZZO
04 43 23	4004094601774		8,20

LEVATAPPI CAMERIERE PROFI WESTMARK

UV1	UV2	IMBALLO
1	5	1/5/45 CD



4 0 0 4 0 9 4 6 0 1 7 7 4



ART	BARCODE	ST.	PREZZO
04 07 31	4004094101274		2,70

LEVATAPPI WOODY LEGNO/ACCIAIO WESTMARK

UV1	UV2	IMBALLO
1	10	1/10/60 CD



4 0 0 4 0 9 4 1 0 1 2 7 4



ART	BARCODE	ST.	PREZZO
04 02 74	4004094618185		18,90

LEVACAPSULE 'LINEA' SATINATO WESTMARK MONOPOL EDITION

UV1	UV2	IMBALLO
1	2	1/10 PB



4 0 0 4 0 9 4 6 1 8 1 8 5



ART	BARCODE	ST.	PREZZO
04 06 65	4004094109478		1,65

2 LEVACAPSULE 'METAL' CROMATI 8 CM WESTMARK

UV1	UV2	IMBALLO
1	10	1/10/200 CD



4 0 0 4 0 9 4 1 0 9 4 7 8



ART	BARCODE	ST.	PREZZO
04 07 30	4004094601361		17,20

TAPPO CHAMPAGNE 'TAPPA MONOPOL EDITION' CROMATO WESTMARK

UV1	UV2	IMBALLO
1	3	1/3/60 HB



4 0 0 4 0 9 4 6 0 1 3 6 1



ART	BARCODE	ST.	PREZZO
04 07 44	8004537407440		3,80

TAPPO UNIVERSALE / CHAMPAGNE EVA

UV1	UV2	IMBALLO
1	12	1/12/96 DC



8 0 0 4 5 3 7 4 0 7 4 4 0



ART	BARCODE	ST.	PREZZO
04 07 45	8004537407457		3,35

TAPPO CHAMPAGNE ACCIAIO INOSSIDABILE EVA

UV1	UV2	IMBALLO
1	6	1/12/96 DC



8 0 0 4 5 3 7 4 0 7 4 5 7



ART	BARCODE	ST.	PREZZO
04 02 73	4004094601385		22,00

TAPPO CHAMPAGNE 'TAPPA MONOPOL EDITION' SATINATO WESTMARK

UV1	UV2	IMBALLO
1	2	1/6 PB



4 0 0 4 0 9 4 6 0 1 3 8 5



ART	BARCODE	ST.	PREZZO
04 02 97	4004094601262		12,30

TAPPO CHAMPAGNE 'VERMO' WESTMARK MONOPOL EDITION

UV1	UV2	IMBALLO
1	3	1/3/54 HB



4 0 0 4 0 9 4 6 0 1 2 6 2



ART	BARCODE	ST.	PREZZO
04 02 96	4004094618765		11,20

TAPPO PER VINO 'CAMPANA' WESTMARK MONOPOL EDITION

UV1	UV2	IMBALLO
1	3	1/3/30 HB



4 0 0 4 0 9 4 6 1 8 7 6 5



ART	BARCODE	ST.	PREZZO
04 07 48	8004537407488		1,45

TAPPO CHAMPAGNE ASSORTITO

UV1	UV2	IMBALLO
50	100	1/50/300 BK



8 0 0 4 5 3 7 4 0 7 4 8 8



ART	BARCODE	ST.	PREZZO
04 07 97	8004537407976		1,55

TAPPO ERMETICO PLASTICA DISPLAY

UV1	UV2	IMBALLO
36	108	36/36 DB



8 0 0 4 5 3 7 4 0 7 9 7 6



ART	BARCODE	ST.	PREZZO
04 07 79	8004537407792		0,95

TAPPO ERMETICO PLASTICA IN DISPLAY

UV1	UV2	IMBALLO
32	64	32/32 DB



8 0 0 4 5 3 7 4 0 7 7 9 2



ART	BARCODE	ST.	PREZZO
04 54 05	8004537454055		2,25

2 TAPPI ERMETICI PLASTICA EVA

UV1	UV2	IMBALLO
1	20	1/20 BC



8 0 0 4 5 3 7 4 5 4 0 5 5



ART	BARCODE	ST.	PREZZO
04 43 18	4004094600081		4,80

TAPPO CHAMPAGNE 'CASCO' COLORI ASSORTITI ABS WESTMARK

UV1	UV2	IMBALLO
1	6	1/6/60 BC



4 0 0 4 0 9 4 6 0 0 0 8 1



ART	BARCODE	ST.	PREZZO
04 43 11	4019889128466		2,60

TAPPO VINO IN SILICONE ROSSO BORDEAUX LURCH

UV1	UV2	IMBALLO
16	32	1/16/304 PG



4 0 1 9 8 8 9 1 2 8 4 6 6



ART	BARCODE	ST.	PREZZO
04 43 12	4019889128473		2,60

TAPPO VINO IN SILICONE BIANCO CREMA LURCH

UV1	UV2	IMBALLO
16	32	1/16/304 PG



4 0 1 9 8 8 9 1 2 8 4 7 3



ART	BARCODE	ST.	PREZZO
04 43 13	4019889128480		2,60

TAPPO VINO IN SILICONE NERO LURCH

UV1	UV2	IMBALLO
16	32	1/16/304 PG



4 0 1 9 8 8 9 1 2 8 4 8 0



ART	BARCODE	ST.	PREZZO
04 07 49	4019889138182		6,25

12 TAPPI CORONA IN SILICONE COLORI ASSORTITI Ø 3 CM LURCH

UV1	UV2	IMBALLO
1	6	1/6/48 AB



4 0 1 9 8 8 9 1 3 8 1 8 2



ART	BARCODE	ST.	PREZZO
04 61 84	4004094992018		4,50

TAPPO DOSATORE TRASPARENTE 'AUTOPOUR' PE 2 CL 9920 WESTMARK

UV1	UV2	IMBALLO
1	5	1/5/60 BC



4 0 0 4 0 9 4 9 9 2 0 1 8



ART	BARCODE	ST.	PREZZO
04 61 85	4004094994012		4,50

TAPPO DOSATORE TRASPARENTE 'AUTOPOUR' PE 4 CL 9940 WESTMARK

UV1	UV2	IMBALLO
1	5	1/5/60 BC



4 0 0 4 0 9 4 9 9 4 0 1 2



ART	BARCODE	ST.	PREZZO
04 61 81	4004094411083		5,90

12 TAPPI VERS.'JET POUR' COLORI ASSOR.NEON PE 4110 WESTMARK

UV1	UV2	IMBALLO
1	12	1/24 DC



4 0 0 4 0 9 4 4 1 1 0 8 3



ART	BARCODE	ST.	PREZZO
04 02 94	4004094619663		12,80

TAPPO PER VINO 'VINO' WESTMARK MONOPOL EDITION

UV1	UV2	IMBALLO
1	3	1/3/60 HB



4 0 0 4 0 9 4 6 1 9 6 6 3



ART	BARCODE	ST.	PREZZO
04 43 37	4004094442087	A	3,95

VERSATORE DECANTATORE ABS WESTMARK

UV1	UV2	IMBALLO
1	6	1/6/54 BC



4 0 0 4 0 9 4 4 4 2 0 8 7



ART	BARCODE	ST.	PREZZO
04 02 95	4004094618666		13,80

VERSATORE VINO CON CHIUSURA 'LUCA' WESTMARK MONOPOL EDITION

UV1	UV2	IMBALLO
1	3	1/3/60 HB



4 0 0 4 0 9 4 6 1 8 6 6 6



ART	BARCODE	ST.	PREZZO
04 02 91	4004094619168		11,50

TAPPO PER VINO 'SILVIO' WESTMARK MONOPOL EDITION

UV1	UV2	IMBALLO
1	3	1/3/60 HB



4 0 0 4 0 9 4 6 1 9 1 6 8



ART	BARCODE	ST.	PREZZO
04 02 92	4004094619267		11,50

VERSATORE PER VINO 'LINO' WESTMARK MONOPOL EDITION

UV1	UV2	IMBALLO
1	3	1/3/60 HB



4 0 0 4 0 9 4 6 1 9 2 6 7



ART	BARCODE	ST.	PREZZO
04 02 93	4004094619366		12,80

POMPA PER VINO 'VITA' WESTMARK MONOPOL EDITION

UV1	UV2	IMBALLO
1	3	1/3/60 HB



4 0 0 4 0 9 4 6 1 9 3 6 6



ART	BARCODE	ST.	PREZZO
04 43 55	8004537443554		4,15

6 VERSATORI WINE STOPPER ALLUMINIO EVA

UV1	UV2	IMBALLO
1	12	1/48/288 BC



8 0 0 4 5 3 7 4 4 3 5 5 4



ART	BARCODE	ST.	PREZZO
04 43 50	8004537443509		6,10

POMPA SALVAVINO ACCIAIO INOSSIDABILE+2TAPPI EVA

UV1	UV2	IMBALLO
1	12	1/12/72 DC



8 0 0 4 5 3 7 4 4 3 5 0 9



ART	BARCODE	ST.	PREZZO
04 43 51	8004537443516		3,75

2 TAPPI TPR PER POMPA VINO 044350 EVA

UV1	UV2	IMBALLO
1	12	1/12/72 DC



8 0 0 4 5 3 7 4 4 3 5 1 6



ART	BARCODE	ST.	PREZZO
04 43 48	8004537443486	A	4,95

POMPA SALVAVINO+2 TAPPI PLASTICA EVA

UV1	UV2	IMBALLO
1	12	1/12/72 DC



8 0 0 4 5 3 7 4 4 3 4 8 6



ART	BARCODE	ST.	PREZZO
04 43 49	8004537443493	A	3,95

2 TAPPI PLASTICA POMPA VINO 044348 EVA

UV1	UV2	IMBALLO
1	12	1/12/72 DC



8 0 0 4 5 3 7 4 4 3 4 9 3



ART	BARCODE	ST.	PREZZO
04 43 03	8004537443035		2,05

2 ANELLI SALVAGOCCE CROMATI EVA

UV1	UV2	IMBALLO
1	10	1/10/60 SC



8 0 0 4 5 3 7 4 4 3 0 3 5



ART	BARCODE	ST.	PREZZO
04 02 90	4004094618468		7,50

2 ANELLI SALVAGOCCE SATINATI WESTMARK MONOPOL EDITION

UV1	UV2	IMBALLO
1	3	1/3/60 HB



4 0 0 4 0 9 4 6 1 8 4 6 8



ART	BARCODE	ST.	PREZZO
04 43 70*	8004537443707	H	14,80

IMBUTO VINO+SETACCIO E BASE ACCIAIO INOSSIDABILE EVA

UV1	UV2	IMBALLO
1	5	1/20 PB



8 0 0 4 5 3 7 4 4 3 7 0 7



ART	BARCODE	ST.	PREZZO
07 20 30	8004537720303		10,50

RAFFREDDABOTTIGLIE RAPIDO 22X39,5CM EVA

UV1	UV2	IMBALLO
1	12	1/24 PB



8 0 0 4 5 3 7 7 2 0 3 0 3



ART	BARCODE	ST.	PREZZO
07 20 35	8004537720358		9,05

GLACETTE ACRILICO 11X23 CM EVA

UV1	UV2	IMBALLO
1	6	1/12 CL



8 0 0 4 5 3 7 7 2 0 3 5 8



ART	BARCODE	ST.	PREZZO
07 21 32	8004537721324		17,40

RAFFREDDABOTTIGLIE ACCIAIO INOSSIDABILE 12X19,5CM EVA

UV1	UV2	IMBALLO
1	12	1/12 PB



8 0 0 4 5 3 7 7 2 1 3 2 4



ART	BARCODE	ST.	PREZZO
07 21 22	8004537721225	A	39,80

COPPA PORTACHAMPAGNE ACCIAIO INOSSIDABILE 39CM EVA

UV1	UV2	IMBALLO
1	2	1/2 LB



8 0 0 4 5 3 7 7 2 1 2 2 5



ART	BARCODE	ST.	PREZZO
07 21 21	8004537721218	A	15,50

SECCHIELLO CHAMPAGNE INOX 19CM-3.8 LITRI EVA

UV1	UV2	IMBALLO
1	10	1/20 AL



8 0 0 4 5 3 7 7 2 1 2 1 8



ART	BARCODE	ST.	PREZZO
07 20 37	8004537720372	A	29,50

GLACETTE ACRILICO 34X26X26CM EVA

UV1	UV2	IMBALLO
1	6	1/6 AL



8 0 0 4 5 3 7 7 2 0 3 7 2



ART	BARCODE	ST.	PREZZO
07 21 01	4004094628962		8,80

COCKTAIL SHAKER 'CASABLANCA' PC 0,5 L WESTMARK

UV1	UV2	IMBALLO
1	6	1/6/48 PB



4 0 0 4 0 9 4 6 2 8 9 6 2



ART	BARCODE	ST.	PREZZO
07 21 02	8004537721027	A	7,95

SHAKER ACCIAIO INOSSIDABILE 0,5L EVA

UV1	UV2	IMBALLO
1	5	1/20 PB



8 0 0 4 5 3 7 7 2 1 0 2 7



ART	BARCODE	ST.	PREZZO
07 21 03	8004537721034	A	8,95

SHAKER ACCIAIO INOSSIDABILE 0,7L EVA

UV1	UV2	IMBALLO
1	5	1/40 PB



8 0 0 4 5 3 7 7 2 1 0 3 4



ART	BARCODE	ST.	PREZZO
07 21 08	4000270698576		2,90

PESTELLO CAIPIRNHA LEGNO DI FAGGIO FSC Ø20CM KESPER

UV1	UV2	IMBALLO
1	10	1/10 CD



4 0 0 0 2 7 0 6 9 8 5 7 6



ART	BARCODE	ST.	PREZZO
02 16 33	4004094308864	A	5,50

SPRUZZATORE PER AGRUMI "SPLASHY" SET 3 PEZZI PP WESTMARK

UV1	UV2	IMBALLO
1	3	1/6/24 HB



4 0 0 4 0 9 4 3 0 8 8 6 4



ART	BARCODE	ST.	PREZZO
02 16 37	7611264312070		27,90

SPREMIAGRUMI ACCIAIO INOSSIDABILE 18/10 'LIMONE' MOHA

UV1	UV2	IMBALLO
1	6	1/6/24 PB



7 6 1 1 2 6 4 3 1 2 0 7 0



ART	BARCODE	ST.	PREZZO
02 16 38	8004537216387		4,95

SPREMIAGRUMI/LIME ALLUMINIO VERDE EVA

UV1	UV2	IMBALLO
1	6	1/6/48 CD



8 0 0 4 5 3 7 2 1 6 3 8 7



ART	BARCODE	ST.	PREZZO
02 16 41	8004537216417	H	6,50

SPREMIAGRUMI ALLUMINIO ARANCIONE EVA

UV1	UV2	IMBALLO
1	6	1/6/24 CD



8 0 0 4 5 3 7 2 1 6 4 1 7



ART	BARCODE	ST.	PREZZO
02 16 35	4004094500060	A	29,70

SPREMIFRUTTA 'LIMONA' PP/ALLUMINIO WESTMARK

UV1	UV2	IMBALLO
1	6	1/30 PB



4 0 0 4 0 9 4 5 0 0 0 6 0



ART	BARCODE	ST.	PREZZO
04 18 16	4004094309380		6,25

SPREMI LIMONI E LIME + COP "FRESH&FRUITY" Ø 7 CM WESTMARK

UV1	UV2	IMBALLO
1	3	1/3/24 BC



4 0 0 4 0 9 4 3 0 9 3 8 0



ART	BARCODE	ST.	PREZZO
04 18 01	4009808321214	A	2,10

SPREMIAGRUMI ASSORTITO PE 10CM BUCHSTEINER

UV1	UV2	IMBALLO
1	10	1/30 SP



4 0 0 9 8 0 8 3 2 1 2 1 4



ART	BARCODE	ST.	PREZZO
04 18 03	4004094000898		4,70

SPREMAGRUMI 'LIMETTA' PP/SAN Ø 17 CM WESTMARK

UV1	UV2	IMBALLO
1	3	1/3/18 SL



4 0 0 4 0 9 4 0 0 0 8 9 8



ART	BARCODE	ST.	PREZZO
04 18 15	7610859153234		4,00

SPREMAGRUMI 'LOFT' SAN/PP Ø 18,5 CM ROTHO

UV1	UV2	IMBALLO
1	6	1/6 BK



7 6 1 0 8 5 9 1 5 3 2 3 4



ART	BARCODE	ST.	PREZZO
04 18 05	026102751466		2,80

SPREMIAGRUMI VETRO 13 CM

UV1	UV2	IMBALLO
1	12	1/12 BK



0 2 6 1 0 2 7 5 1 4 6 6



ART	BARCODE	ST.	PREZZO
04 18 14	4004094309465		20,70

SPREMAGRUMI ACCIAIO INOSSIDABILE 0,5 L Ø 14 CM WESTMARK

UV1	UV2	IMBALLO
1	3	1/6/36 PB



4 0 0 4 0 9 4 3 0 9 4 6 5



ART	BARCODE	ST.	PREZZO
04 18 06	8004537418064		15,30

SPREMIAGRUMI ACCIAIO INOSSIDABILE 18/8 16CM EVA

UV1	UV2	IMBALLO
1	6	1/6/48 PB



8 0 0 4 5 3 7 4 1 8 0 6 4



ART	BARCODE	ST.	PREZZO
04 16 08	7610859202949		13,35

MISURA GRADUATA MULTIUSO+COPERCHIO 'LOFT' SAN 1.5 LITR ROTHO

UV1	UV2	IMBALLO
1	4	1/4 SL



7 6 1 0 8 5 9 2 0 2 9 4 9



ART	BARCODE	ST.	PREZZO
04 18 10	8004537418101		57,50

SPREMIAGRUMI ALTO ROSSO 39CM EVA

UV1	UV2	IMBALLO
1	2	1/2 PB



8 0 0 4 5 3 7 4 1 8 1 0 1



ART	BARCODE	ST.	PREZZO
04 18 38	8004537481389		57,50

SPREMIAGRUMI ALTO NERO 39CM EVA

UV1	UV2	IMBALLO
1	2	1/2 PB



8 0 0 4 5 3 7 4 8 1 3 8 9



ART	BARCODE	ST.	PREZZO
04 18 11	8004537418118		83,50

SPREMIAGRUMI/MELOGRANO ROSSO 47CM EVA

UV1	UV2	IMBALLO
1	2	1/2 PB



8 0 0 4 5 3 7 4 1 8 1 1 8



ART	BARCODE	ST.	PREZZO
04 18 39	8004537418392		83,50

SPREMIAGRUMI/MELOGRANO NERO 47CM EVA

UV1	UV2	IMBALLO
1	2	1/2 PB



8 0 0 4 5 3 7 4 1 8 3 9 2



ART	BARCODE	ST.	PREZZO
04 18 08*	8004537418088	H	26,50

SPREMIAGRUMI ALTO ACCIAIO INOSSIDABILE/CROMATO 37CM EVA

UV1	UV2	IMBALLO
1	6	1/6 PB



8 0 0 4 5 3 7 4 1 8 0 8 8



ART	BARCODE	ST.	PREZZO
04 18 36	8004537418361	A	19,80

SPREMIAGRUMI ALTO ROSSO 37CM EVA

UV1	UV2	IMBALLO
1	6	1/6 PB



8 0 0 4 5 3 7 4 1 8 3 6 1



ART	BARCODE	ST.	PREZZO
04 18 04	8004537418040	A	39,50

SPREMIAGRUMI BAR CROMATO 20 CM EVA

UV1	UV2	IMBALLO
1	6	1/6 PB



8 0 0 4 5 3 7 4 1 8 0 4 0



ART	BARCODE	ST.	PREZZO
04 18 29	8004537418293	H	84,00

SPREMIAGRUMI/MELOGRANO CROMATO 43CM EVA

UV1	UV2	IMBALLO
1	2	1/2 PB



8 0 0 4 5 3 7 4 1 8 2 9 3



ART	BARCODE	ST.	PREZZO
04 17 33	4019889136614		12,50

FORMAGHIACCIO "SFERA Ø 3 CM" LURCH

UV1	UV2	IMBALLO
1	6	1/6/24 PB



4 0 1 9 8 8 9 1 3 6 6 1 4



ART	BARCODE	ST.	PREZZO
04 17 34	4019889136621		12,20

FORMAGHIACCIO SET 2 PEZZI "SFERA Ø 6 CM" LURCH

UV1	UV2	IMBALLO
1	6	1/6/24 PB



4 0 1 9 8 8 9 1 3 6 6 2 1



ART	BARCODE	ST.	PREZZO
04 17 31	4019889136577		14,40

FORMAGHIACCIO "CUBO 3X3 CM" LURCH

UV1	UV2	IMBALLO
1	6	1/6/24 PB



4 0 1 9 8 8 9 1 3 6 5 7 7



ART	BARCODE	ST.	PREZZO
04 17 32	4019889136584		15,00

FORMAGHIACCIO "CUBO 4X4 CM" LURCH

UV1	UV2	IMBALLO
1	6	1/6/24 PB



4 0 1 9 8 8 9 1 3 6 5 8 4



ART	BARCODE	ST.	PREZZO
04 17 42	4013291450061		4,80

2 FORMAGHIACCIO + COPERCHIO PE 25,5CM WUELLNER

UV1	UV2	IMBALLO
1	12	1/12 SP



4 0 1 3 2 9 1 4 5 0 0 6 1



ART	BARCODE	ST.	PREZZO
04 15 63	7610859072566		3,20

FORMAGHIACCIO 'DIAMOND' PP 26,3X12,2X35 CM ROTHO

UV1	UV2	IMBALLO
1	8	1/8 SP



7 6 1 0 8 5 9 0 7 2 5 6 6



ART	BARCODE	ST.	PREZZO
02 18 46	8004537218466	H	26,50

TRITAGHIACCIO A MANOVELLA ACRILICO EVA

UV1	UV2	IMBALLO
1	6	1/12 PB



8 0 0 4 5 3 7 2 1 8 4 6 6

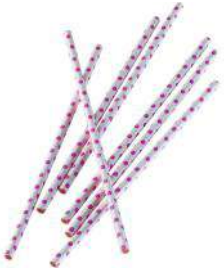

ART	BARCODE	ST.	PREZZO
10 16 23	4004094013843		2,80

50 CANNUCCE DI CARTA BIANCO/PINK Ø6 X 197MM WESTMARK

UV1	UV2	IMBALLO
1	4	1/4/52 HB



4 0 0 4 0 9 4 0 1 3 8 4 3



ART	BARCODE	ST.	PREZZO
10 16 21	4004094524066		2,80

50 CANNUCCE DI CARTA BIANCO/BLU Ø6 X 197MM WESTMARK

UV1	UV2	IMBALLO
1	4	1/4/52 HB



4 0 0 4 0 9 4 5 2 4 0 6 6



ART	BARCODE	ST.	PREZZO
10 16 22	4004094013836		2,80

50 CANNUCCE DI CARTA VERDE/BIANCO Ø6 X 197MM WESTMARK

UV1	UV2	IMBALLO
1	4	1/4/52 HB



4 0 0 4 0 9 4 0 1 3 8 3 6



ART	BARCODE	ST.	PREZZO
10 16 31	4004094626265		7,95

6 CANNUCCE DI VETRO TRASPARENTE+SCOVOLINO Ø8 X 200MM WESTMA

UV1	UV2	IMBALLO
1	4	1/4/48 HB



4 0 0 4 0 9 4 6 2 6 2 6 5



ART	BARCODE	ST.	PREZZO
10 16 32	4004094627262		6,95

4 CANNUCCE INOX DIRITTE+SCOVOLINO Ø6 X 215MM WESTMARK

UV1	UV2	IMBALLO
1	4	1/4/48 HB



4 0 0 4 0 9 4 6 2 7 2 6 2

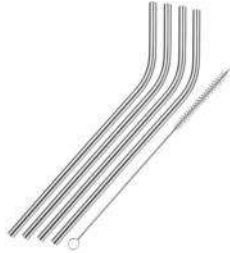

ART	BARCODE	ST.	PREZZO
10 16 33	4004094627460		7,50

4 CANNUCCE INOX CURVATE+SCOVOLINO Ø6 X 215MM WESTMARK

UV1	UV2	IMBALLO
1	4	1/4/48 HB



4 0 0 4 0 9 4 6 2 7 4 6 0

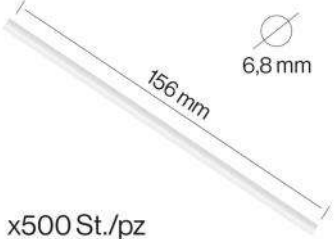

156 mm
6,8 mm

x500 St./pz

ART	BARCODE	ST.	PREZZO
10 16 41	8004537016413		7,95

500 CANNUCCE BIO BIANCHE Ø 6.8 X 156 MM

UV1	UV2	IMBALLO
1	20	1/20 BB



8 0 0 4 5 3 7 0 1 6 4 1 3



156 mm
6,8 mm

x500 St./pz

ART	BARCODE	ST.	PREZZO
10 16 42	8004537016420		8,50

500 CANNUCCE BIO NERE Ø 6.8 X 156 MM

UV1	UV2	IMBALLO
1	20	1/20 BB



8 0 0 4 5 3 7 0 1 6 4 2 0



207 mm
6,8 mm

x500 St./pz

ART	BARCODE	ST.	PREZZO
10 16 43	8004537016437		10,40

500 CANNUCCE BIO BIANCHE Ø 6.8 X 207 MM

UV1	UV2	IMBALLO
1	20	1/20 BB



8 0 0 4 5 3 7 0 1 6 4 3 7



207 mm
6,8 mm

x500 St./pz

ART	BARCODE	ST.	PREZZO
10 16 44	8004537016444		10,95

500 CANNUCCE BIO NERE Ø 6.8 X 207 MM

UV1	UV2	IMBALLO
1	20	1/20 BB



8 0 0 4 5 3 7 0 1 6 4 4 4

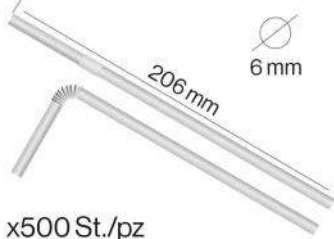

206 mm
6 mm

x500 St./pz

ART	BARCODE	ST.	PREZZO
10 16 45	8004537016451		11,80

500 CANNUCCE BIO BIANCHE 'FLEX' Ø 6 X 206 MM

UV1	UV2	IMBALLO
1	20	1/20 BB



8 0 0 4 5 3 7 0 1 6 4 5 1



206 mm
6 mm

x500 St./pz



ART	BARCODE	ST.	PREZZO
10 16 46	8004537016468		12,50

500 CANNUCCE BIO NERE 'FLEX' Ø 6 X 206 MM

UV1	UV2	IMBALLO
1	20	1/20 BB

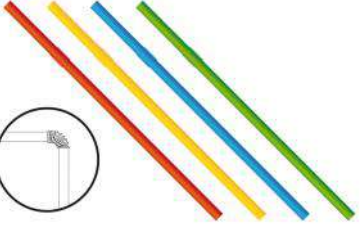

8 0 0 4 5 3 7 0 1 6 4 6 8

ART	BARCODE	ST.	PREZZO
10 16 47	8004537014679		14,30

500 CANNUCCE BIO COLORATE 'FLEX' Ø 6 X 206 MM

UV1	UV2	IMBALLO
1	20	1/20 BB



8 0 0 4 5 3 7 0 1 4 6 7 9

Accessori Tavola Servire



ART	BARCODE	ST.	PREZZO
04 33 03	4000270204425		4,25

TAGLIERE ROTONDO LEGNO ACACIA
25CM EVA

UV1	UV2	IMBALLO
1	12	1/12 BK



4 0 0 0 2 7 0 2 0 4 4 2 5



ART	BARCODE	ST.	PREZZO
04 33 04	4000270204449		6,50

TAGLIERE ROTONDO LEGNO ACACIA
30CM

UV1	UV2	IMBALLO
1	12	1/12 SP



4 0 0 0 2 7 0 2 0 4 4 4 9



ART	BARCODE	ST.	PREZZO
04 33 14	4000270284489		22,50

PIATTO GIREVOLE ACACIA FSC Ø40 CM
KESPER

UV1	UV2	IMBALLO
1	3	1/3 SP



4 0 0 0 2 7 0 2 8 4 4 8 9



ART	BARCODE	ST.	PREZZO
04 34 80	4000270584497		17,40

PIATTO GIREVOLE BAMBU FSC Ø35 CM
KESPER

UV1	UV2	IMBALLO
1	6	1/3 SL



4 0 0 0 2 7 0 5 8 4 4 9 7



ART	BARCODE	ST.	PREZZO
04 34 30	4000270584633		12,40

TAGLIERE PIZZA BAMBU' FSC Ø32CM
KESPER

UV1	UV2	IMBALLO
1	5	1/5 SL



4 0 0 0 2 7 0 5 8 4 6 3 3



ART	BARCODE	ST.	PREZZO
04 34 72	4000270586415		20,50

TAGLIERE FORMAGGIO+POSATE BAMBU
30x20x8CM KESPER

UV1	UV2	IMBALLO
1	4	1/4 PB



4 0 0 0 2 7 0 5 8 6 4 1 5



ART	BARCODE	ST.	PREZZO
04 34 45	4000270612053		15,00

TAGLIERE+MANICO CORTECCIA LEGNO
ONTANO 30-35X18X2CM KESPER

UV1	UV2	IMBALLO
1	5	1/5 SL



4 0 0 0 2 7 0 6 1 2 0 5 3



ART	BARCODE	ST.	PREZZO
04 34 46	4000270612008		11,50

TAGLIERE CORTECCIA ONTANO
35-39X16X1,5CM KESPER

UV1	UV2	IMBALLO
1	5	1/5 SL



4 0 0 0 2 7 0 6 1 2 0 0 8



ART	BARCODE	ST.	PREZZO
04 34 47	4000270612015		13,50

TAGLIERE CORTECCIA ONTANO
40-49X17X1,5CM KESPER

UV1	UV2	IMBALLO
1	5	1/5 AL



4 0 0 0 2 7 0 6 1 2 0 1 5



ART	BARCODE	ST.	PREZZO
04 34 48	4000270612022		18,20

TAGLIERE CORTECCIA ONTANO
50-59X20X1,8CM KESPER

UV1	UV2	IMBALLO
1	5	1/5 AL



4 0 0 0 2 7 0 6 1 2 0 2 2



ART	BARCODE	ST.	PREZZO
04 34 49	4000270612039		28,50

TAGLIERE CORTECCIA ONTANO
60-69X21X1,8CM KESPER

UV1	UV2	IMBALLO
1	5	1/5 SL



4 0 0 0 2 7 0 6 1 2 0 3 9



ART	BARCODE	ST.	PREZZO
04 34 50	4000270612046		41,50

TAGLIERE CORTECCIA ONTANO
70-79X25X2CM KESPER

UV1	UV2	IMBALLO
1	5	1/5 SL



4 0 0 0 2 7 0 6 1 2 0 4 6



ART	BARCODE	ST.	PREZZO
04 34 29	4000270689000	A	9,25

TAGLIERE OVALE LEGNO DI FAGGIO
FSC+SCANALATURA 40X23 KESPER

UV1	UV2	IMBALLO
1	5	1/10 SP



4 0 0 0 2 7 0 6 8 9 0 0 0



ART	BARCODE	ST.	PREZZO
04 33 31	4000270285912		16,90

TAGLIERE/COPRIPIASTRA ACACIA FSC
50X28X4 CM KESPER

UV1	UV2	IMBALLO
1	4	1/4 SL



4 0 0 0 2 7 0 2 8 5 9 1 2



ART	BARCODE	ST.	PREZZO
04 33 27	4000270281969		13,95

TAGLIERE/VASSOIO ACACIA FSC
38X24X2,5 CM KESPER

UV1	UV2	IMBALLO
1	6	1/6 SL



4 0 0 0 2 7 0 2 8 1 9 6 9



ART	BARCODE	ST.	PREZZO
04 33 44	4000270281952		22,00

TAGLIERE LEGNO DI ACACIA
FSC+MANICO 71-85X17-21CM KESPER

UV1	UV2	IMBALLO
1	5	1/5 SL



4 0 0 0 2 7 0 2 8 1 9 5 2



ART	BARCODE	ST.	PREZZO
04 34 16	4000270384509	H	8,25

PIATTO BUFFET MARMO 30X20CM
KESPER

UV1	UV2	IMBALLO
1	5	1/5 WB



4 0 0 0 2 7 0 3 8 4 5 0 9



ART	BARCODE	ST.	PREZZO
04 34 98	4000270381126	H	9,50

PIATTO BUFFET ARDESIA ROTONDO Ø
35,5 KESPER

UV1	UV2	IMBALLO
1	5	1/5 SP



4 0 0 0 2 7 0 3 8 1 1 2 6



ART	BARCODE	ST.	PREZZO
04 34 14	4000270384011	H	14,50

PIATTO BUFFET GRANITO 38X28CM
KESPER

UV1	UV2	IMBALLO
1	3	1/3 WB



4 0 0 0 2 7 0 3 8 4 0 1 1



ART	BARCODE	ST.	PREZZO
04 34 92	4000270381003		4,95

PIATTO BUFFET ARDESIA 30x20CM
KESPER

UV1	UV2	IMBALLO
1	5	1/5 SP



4 0 0 0 2 7 0 3 8 1 0 0 3



ART	BARCODE	ST.	PREZZO
04 34 93	4000270381010		7,90

PIATTO BUFFET ARDESIA 40x30CM
KESPER

UV1	UV2	IMBALLO
1	5	1/5 SP



4 0 0 0 2 7 0 3 8 1 0 1 0



ART	BARCODE	ST.	PREZZO
04 34 96	4000270381133	H	19,90

PIATTO BUFFET ARDESIA 45X30CM
KESPER

UV1	UV2	IMBALLO
1	4	1/4 WB



4 0 0 0 2 7 0 3 8 1 1 3 3



ART	BARCODE	ST.	PREZZO
04 34 94	4000270381232		3,25

PIATTO BUFFET ARDESIA 38x13CM
KESPER

UV1	UV2	IMBALLO
1	10	1/10 SP



4 0 0 0 2 7 0 3 8 1 2 3 2



ART	BARCODE	ST.	PREZZO
04 34 95	4000270381027		12,90

PIATTO BUFFET ARDESIA 60x30CM
KESPER

UV1	UV2	IMBALLO
1	5	1/5 SP



4 0 0 0 2 7 0 3 8 1 0 2 7



ART	BARCODE	ST.	PREZZO
04 34 37	4000270381300		11,30

PIATTO BUFFET ARDESIA/BAMBU'
34X26X1.5 CM KESPER

UV1	UV2	IMBALLO
1	4	1/4 SP



4 0 0 0 2 7 0 3 8 1 3 0 0



ART	BARCODE	ST.	PREZZO
04 34 38	4000270381317		13,00

PIATTO BUFFET ARDESIA/BAMBU'
45X30X1.5 CM KESPER

UV1	UV2	IMBALLO
1	4	1/4 SP



4 0 0 0 2 7 0 3 8 1 3 1 7



ART	BARCODE	ST.	PREZZO
04 34 39	4000270381188		26,50

ETAGERE 2 RIPIANI ARDESIA/BAMBU' 45
X 6 X 31 CM KESPER

UV1	UV2	IMBALLO
1	3	1/3 PB



4 0 0 0 2 7 0 3 8 1 1 8 8



ART	BARCODE	ST.	PREZZO
04 34 42	4000270381195	A	22,50

ETAGERE 3 RIPIANI ARDESIA/BAMBU' Ø
30 X 34 CM KESPER

UV1	UV2	IMBALLO
1	3	1/3 PB



4 0 0 0 2 7 0 3 8 1 1 9 5



ART	BARCODE	ST.	PREZZO
04 34 01	4000270326172		2,60

INSALATIERA MF DARKWOOD Ø 15 X 7
CM KESPER

UV1	UV2	IMBALLO
1	5	1/5/60 CL



4 0 0 0 2 7 0 3 2 6 1 7 2



ART	BARCODE	ST.	PREZZO
04 34 02	4000270326271		6,25

INSALATIERA MF DARKWOOD Ø 25 X 11
CM KESPER

UV1	UV2	IMBALLO
1	5	1/5/20 CL



4 0 0 0 2 7 0 3 2 6 2 7 1



ART	BARCODE	ST.	PREZZO
04 33 89	4000270630255		10,50

CIOTOLA ROTONDA BAMU Ø28X8CM
KESPER

UV1	UV2	IMBALLO
1	10	1/10 AL



4 0 0 0 2 7 0 6 3 0 2 5 5



ART	BARCODE	ST.	PREZZO
04 33 90	4000270630309		11,70

CIOTOLA ROTONDA BAMU Ø30X9CM
KESPER

UV1	UV2	IMBALLO
1	5	1/5/10 AL



4 0 0 0 2 7 0 6 3 0 3 0 9



ART	BARCODE	ST.	PREZZO
09 14 62*	4000753141575	H	6,00

CIOTOLA VETRO FUCSIA 'PLAY OF
COLORS' Ø14,5 CM BOHEMIA

UV1	UV2	IMBALLO
1	6	1/6 SL



4 0 0 0 7 5 3 1 4 1 5 7 5



ART	BARCODE	ST.	PREZZO
09 14 64*	4000753141599	H	6,00

CIOTOLA VETRO GIALLO 'PLAY OF
COLORS' Ø14,5 CM BOHEMIA

UV1	UV2	IMBALLO
1	6	1/6 SL



4 0 0 0 7 5 3 1 4 1 5 9 9



ART	BARCODE	ST.	PREZZO
09 14 66*	4000753141612	H	6,00

CIOTOLA VETRO PINK 'PLAY OF COLORS'
Ø14,5 CM BOHEMIA

UV1	UV2	IMBALLO
1	6	1/6 SL



4 0 0 0 7 5 3 1 4 1 6 1 2



ART	BARCODE	ST.	PREZZO
04 50 51*	4009085201995	H	6,60

CIOTOLA BIANCA MELAMINA 500ML -
15CM WACA

UV1	UV2	IMBALLO
1	5	1/5 BK



4 0 0 9 0 8 5 2 0 1 9 9 5



ART	BARCODE	ST.	PREZZO
04 50 52	4009085191708	H	7,20

CIOTOLA BIANCA MELAMINA 900ML - 18CM WACA

UV1	UV2	IMBALLO
1	5	1/5 BK



4 0 0 9 0 8 5 1 9 1 7 0 8



ART	BARCODE	ST.	PREZZO
04 50 53	4009085202008	H	8,60

CIOTOLA BIANCA MELAMINA 1500ML - 21CM WACA

UV1	UV2	IMBALLO
1	5	1/5 BK



4 0 0 9 0 8 5 2 0 2 0 0 8



ART	BARCODE	ST.	PREZZO
04 50 55	4009085041799	H	8,90

CIOTOLA NERA MELAMINA 1 LITRO - 15.6CM WACA

UV1	UV2	IMBALLO
1	5	1/5 BK



4 0 0 9 0 8 5 0 4 1 7 9 9



ART	BARCODE	ST.	PREZZO
04 50 56	4009085093804	H	12,90

CIOTOLA BIANCA MELAMINA 2 LITRI - 20CM WACA

UV1	UV2	IMBALLO
1	3	1/3 BK



4 0 0 9 0 8 5 0 9 3 8 0 4



ART	BARCODE	ST.	PREZZO
04 50 57	4009085019170	H	12,90

CIOTOLA NERA MELAMINA 2 LITRI - 20CM WACA

UV1	UV2	IMBALLO
1	3	1/3 BK



4 0 0 9 0 8 5 0 1 9 1 7 0



ART	BARCODE	ST.	PREZZO
04 50 58	4009085094207	H	18,90

CIOTOLA BIANCA MELAMINA 3 LITRI - 22CM WACA

UV1	UV2	IMBALLO
1	2	1/2 BK



4 0 0 9 0 8 5 0 9 4 2 0 7



ART	BARCODE	ST.	PREZZO
04 50 59	4009085010993	H	18,90

CIOTOLA NERA MELAMINA 3 LITRI - 22CM WACA

UV1	UV2	IMBALLO
1	2	1/2 BK



4 0 0 9 0 8 5 0 1 0 9 9 3



ART	BARCODE	ST.	PREZZO
04 50 61	4009085095808	A	15,90

PIATTO PORTA-TORTE RETTANGOLARE BIANCO MELAMINA 40X15CM WACA

UV1	UV2	IMBALLO
1	2	1/2 BK



4 0 0 9 0 8 5 0 9 5 8 0 8



ART	BARCODE	ST.	PREZZO
09 14 57	8435271294124	H	3,50

BICCHIERE VETRO 'FLORA' 400ML

UV1	UV2	IMBALLO
1	6	1/6 BK



8 4 3 5 2 7 1 2 9 4 1 2 4



ART	BARCODE	ST.	PREZZO
09 08 30	8593419185694		14,30

CARAFFA VETRO CON RINFRESCATORE SIMAX 2,5L BOHEMIA

UV1	UV2	IMBALLO
1	3	1/6 BK



8 5 9 3 4 1 9 1 8 5 6 9 4



ART	BARCODE	ST.	PREZZO
09 07 98	8593419185724		21,30

CARAFFA+COPERCHIO VERSATORE VETRO 1,1L SIMAX

UV1	UV2	IMBALLO
1	4	1/4 PB



8 5 9 3 4 1 9 1 8 5 7 2 4



ART	BARCODE	ST.	PREZZO
09 07 95	4004094629563		30,50

CARAFFA VETRO+FILTERO INOX 1,0L WESTMARK

UV1	UV2	IMBALLO
1	4	1/4/16 PB



4 0 0 4 0 9 4 6 2 9 5 6 3



ART	BARCODE	ST.	PREZZO
09 07 97	032622021330	A	4,40

CARAFFA VETRO 'WATER' 0,75L

UV1	UV2	IMBALLO
1	6	1/6 BK



0 3 2 6 2 2 0 2 1 3 3 0



ART	BARCODE	ST.	PREZZO
09 08 37	8593419991219		9,60

CARAFFA VETRO "CYLINDER" 1,0 L
BOHEMIA

UV1	UV2	IMBALLO
1	6	1/6 BK



8 5 9 3 4 1 9 9 9 1 2 1 9



ART	BARCODE	ST.	PREZZO
09 08 38	8593419991233		10,90

CARAFFA VETRO "CYLINDER" 2,0 L
BOHEMIA

UV1	UV2	IMBALLO
1	6	1/6 BK



8 5 9 3 4 1 9 9 9 1 2 3 3



ART	BARCODE	ST.	PREZZO
07 15 26	8693357086692		9,70

PORTABURRO VETRO 17X10.5X5 CM

UV1	UV2	IMBALLO
1	6	1/12 PB



8 6 9 3 3 5 7 0 8 6 6 9 2



ART	BARCODE	ST.	PREZZO
04 17 17	4008256140033		4,30

PORTABURRO OVALE ACCIAIO
INOSSIDABILE+COPERCHIO 19CM

UV1	UV2	IMBALLO
1	10	1/20 SP



4 0 0 8 2 5 6 1 4 0 0 3 3



ART	BARCODE	ST.	PREZZO
04 17 09	4021322094009	A	3,60

PORTABURRO+COPERCHIO SAN 18CM
KAYSER

UV1	UV2	IMBALLO
1	8	1/48 SP



4 0 2 1 3 2 2 0 9 4 0 0 9



ART	BARCODE	ST.	PREZZO
04 17 08	7610859094247		3,35

PORTABURRO 'FRESH' SAN/PP
18X9,5X6,9 CM ROTHO

UV1	UV2	IMBALLO
1	6	1/6 SL



7 6 1 0 8 5 9 0 9 4 2 4 7



ART	BARCODE	ST.	PREZZO
08 10 06	4009290088411		11,60

PORTABURRO PORCELLANA BIANCA
"AVANTI" 18,5X13,8X6CM

UV1	UV2	IMBALLO
1	6	1/24 SP



4 0 0 9 2 9 0 0 8 8 4 1 1



ART	BARCODE	ST.	PREZZO
04 34 73	4000270586439		7,20

PORTAFORMAGGI BAMBU' FSC 25X20X8
CM KESPER

UV1	UV2	IMBALLO
1	4	1/4 SP



4 0 0 0 2 7 0 5 8 6 4 3 9



ART	BARCODE	ST.	PREZZO
07 22 12*	8004537722123	A	2,70

TOVAGLIETTA BIANCA 45X30 CM EVA

UV1	UV2	IMBALLO
6	48	1/6/96 SP



8 0 0 4 5 3 7 7 2 2 1 2 3



ART	BARCODE	ST.	PREZZO
07 22 13*	8004537722130	A	2,70

TOVAGLIETTA CREMA 45X30 CM EVA

UV1	UV2	IMBALLO
6	48	1/6/96 SP



8 0 0 4 5 3 7 7 2 2 1 3 0



ART	BARCODE	ST.	PREZZO
07 22 14*	8004537722147	A	2,70

TOVAGLIETTA TESTA DI MORO 45X30 CM
EVA

UV1	UV2	IMBALLO
6	48	1/6/96 SP



8 0 0 4 5 3 7 7 2 2 1 4 7



ART	BARCODE	ST.	PREZZO
07 22 15	8004537722154	A	2,70

TOVAGLIETTA NERA 45X30 CM EVA

UV1	UV2	IMBALLO
6	48	1/6/96 PG



8 0 0 4 5 3 7 7 2 2 1 5 4



ART	BARCODE	ST.	PREZZO
07 22 16	8004537722161	A	2,70

TOVAGLIETTA ROSSA 45X30 CM EVA

UV1	UV2	IMBALLO
6	48	1/6/96 SP



8 0 0 4 5 3 7 7 2 2 1 6 1



ART	BARCODE	ST.	PREZZO
07 22 17	8004537722178	A	2,70

TOVAGLIETTA ARANCIONE 45X30 CM EVA

UV1	UV2	IMBALLO
6	48	1/6/96 SP



8 0 0 4 5 3 7 7 2 2 1 7 8



ART	BARCODE	ST.	PREZZO
07 22 18	8004537722185	A	2,70

TOVAGLIETTA GIALLA 45X30 CM EVA

UV1	UV2	IMBALLO
6	48	1/6/96 SP



8 0 0 4 5 3 7 7 2 2 1 8 5



ART	BARCODE	ST.	PREZZO
07 22 19	8004537722192	A	2,70

TOVAGLIETTA VERDE LIMONE 45X30 CM EVA

UV1	UV2	IMBALLO
6	48	1/6/96 SP



8 0 0 4 5 3 7 7 2 2 1 9 2



ART	BARCODE	ST.	PREZZO
07 22 20	8004537722208	A	2,70

TOVAGLIETTA BLU 45X30 CM EVA

UV1	UV2	IMBALLO
6	48	1/6/96 SP



8 0 0 4 5 3 7 7 2 2 2 0 8



ART	BARCODE	ST.	PREZZO
07 22 21	8004537722215	A	2,70

TOVAGLIETTA AZZURRA 45X30 CM EVA

UV1	UV2	IMBALLO
6	48	1/6/96 SP



8 0 0 4 5 3 7 7 2 2 2 1 5



ART	BARCODE	ST.	PREZZO
07 22 22	8004537722222	A	2,70

TOVAGLIETTA TURCHESE 45X30 CM EVA

UV1	UV2	IMBALLO
6	48	1/6/96 PG



8 0 0 4 5 3 7 7 2 2 2 2 2



ART	BARCODE	ST.	PREZZO
07 22 25	8004537722253	A	2,70

TOVAGLIETTA ROSA 45X30 CM EVA

UV1	UV2	IMBALLO
6	48	1/6/96 SP



8 0 0 4 5 3 7 7 2 2 2 5 3



ART	BARCODE	ST.	PREZZO
05 25 19	4000270692956		14,90

CESTINO PORTA-POSATE LEGNO DI PINO Ø17 X 20 CM KESPER

UV1	UV2	IMBALLO
1	8	1/8 HT



4 0 0 0 2 7 0 6 9 2 9 5 6



ART	BARCODE	ST.	PREZZO
05 25 14	4000270692765		11,50

PORTAPOSATE/PORTASALSE LEGNO FSC+LAVAGNA 20X26X16 CM KESPER

UV1	UV2	IMBALLO
1	5	1/5 SL



4 0 0 0 2 7 0 6 9 2 7 6 5



ART	BARCODE	ST.	PREZZO
04 32 75	4000270708534		7,25

VASSOIO BAMBU' FSC 30X12X6CM KESPER

UV1	UV2	IMBALLO
1	6	1/6 SP



4 0 0 0 2 7 0 7 0 8 5 3 4



ART	BARCODE	ST.	PREZZO
05 25 15	4000270708503	A	14,90

PORTAPOSATE/TOVAGLIOLI BAMBU' FSC
4 SCOMP. 35X14X12CM KESPER

UV1	UV2	IMBALLO
1	6	1/6 SP



4 0 0 0 2 7 0 7 0 8 5 0 3



ART	BARCODE	ST.	PREZZO
05 25 16	4000270708558	A	13,50

PORTAPOSATE/SALSE BAMBU' FSC 8
SCOMP. 36X15X7.5CM KESPER

UV1	UV2	IMBALLO
1	6	1/6 SL



4 0 0 0 2 7 0 7 0 8 5 5 8



ART	BARCODE	ST.	PREZZO
05 25 17	4000270708527		9,50

PORTAPOSATE/TOVAGLIOLI BAMBU' FSC
5 SCOMP. 21,5X9X18CM KESPE

UV1	UV2	IMBALLO
1	4	1/4 SP



4 0 0 0 2 7 0 7 0 8 5 2 7



ART	BARCODE	ST.	PREZZO
05 32 58	4000270580260	A	15,90

PORTACOLTELLI DA CASSETTO BAMBU'
FSC 39.5X14.7X6.2CM KESPER

UV1	UV2	IMBALLO
1	3	1/3 SP



4 0 0 0 2 7 0 5 8 0 2 6 0



ART	BARCODE	ST.	PREZZO
05 32 59	4000270580277		21,30

CEPPO COLTELLI + PORTA-UTENSILI
BAMBU' FSC 20,5X9.4X2CM KESP

UV1	UV2	IMBALLO
1	3	1/3 SL



4 0 0 0 2 7 0 5 8 0 2 7 7



ART	BARCODE	ST.	PREZZO
07 22 40	4000270178306		2,95

CESTINO PANE ROTONDO PLASTIFICATO
Ø25CM KESPER

UV1	UV2	IMBALLO
1	10	1/10/120 CL



4 0 0 0 2 7 0 1 7 8 3 0 6



ART	BARCODE	ST.	PREZZO
07 22 41	4000270178313		4,15

CESTINO PANE ROTONDO PLASTIFICATO
Ø31CM KESPER

UV1	UV2	IMBALLO
1	10	1/10/120 CL



4 0 0 0 2 7 0 1 7 8 3 1 3



ART	BARCODE	ST.	PREZZO
07 22 42	4000270178320		2,10

CESTINO PANE OVALE PLASTIFICATO
21X17X6CM KESPER

UV1	UV2	IMBALLO
1	10	1/10/120 CL



4 0 0 0 2 7 0 1 7 8 3 2 0



ART	BARCODE	ST.	PREZZO
07 22 43	4000270178337		2,35

CESTINO PANE OVALE PLASTIFICATO
24X20X6CM KESPER

UV1	UV2	IMBALLO
1	10	1/10/120 CL



4 0 0 0 2 7 0 1 7 8 3 3 7



ART	BARCODE	ST.	PREZZO
07 22 44	4000270178368		4,15

CESTINO PANE+MAN PLASTIFICATO
29X18X13CM KESPER

UV1	UV2	IMBALLO
1	10	1/5/120 CL



4 0 0 0 2 7 0 1 7 8 3 6 8



ART	BARCODE	ST.	PREZZO
07 22 45	4000270178405		4,60

CESTINO PANE ROTONDO PLASTIFICATO
Ø28 CM KESPER

UV1	UV2	IMBALLO
1	5	1/5/80 CL



4 0 0 0 2 7 0 1 7 8 4 0 5



ART	BARCODE	ST.	PREZZO
07 22 47	4000270178481		5,30

CESTINO BAGUETTE PLASTIFICATO
41X13,5X7CM KESPER

UV1	UV2	IMBALLO
1	5	1/5/80 CL



4 0 0 0 2 7 0 1 7 8 4 8 1



ART	BARCODE	ST.	PREZZO
07 22 48	4000270178221		6,40

CESTINO PANE/FRUTTA PLASTIFICATO
28X21X13CM KESPER

UV1	UV2	IMBALLO
1	10	1/5/80 CL



4 0 0 0 2 7 0 1 7 8 2 2 1



ART	BARCODE	ST.	PREZZO
04 07 70	8004537407709		6,90

4 FERMATOVAGLIE A MOLLE NICHELATE
EVA

UV1	UV2	IMBALLO
1	6	1/6/60 BC



8 0 0 4 5 3 7 4 0 7 7 0 9



ART	BARCODE	ST.	PREZZO
07 22 52	4000270178252		11,90

CESTINO CON MANICI PLASTIFICATO
35X24X18CM KESPER

UV1	UV2	IMBALLO
1	5	1/5/30 CL



4 0 0 0 2 7 0 1 7 8 2 5 2



ART	BARCODE	ST.	PREZZO
07 22 57	4000270198021		6,50

CESTINO PANE/FRUTTA PLASTIFICATO
Ø24CM KESPER

UV1	UV2	IMBALLO
1	5	1/5/30 CL



4 0 0 0 2 7 0 1 9 8 0 2 1



ART	BARCODE	ST.	PREZZO
07 22 58	4000270198038		6,10

CESTINO PANE/FRUTTA PLASTIFICATO
20X25CM KESPER

UV1	UV2	IMBALLO
1	5	1/5/30 CL



4 0 0 0 2 7 0 1 9 8 0 3 8



ART	BARCODE	ST.	PREZZO
07 22 59	4000270198045		8,20

CESTINO PANE/FRUTTA PLASTIFICATO
30X23CM KESPER

UV1	UV2	IMBALLO
1	5	1/5/30 CL



4 0 0 0 2 7 0 1 9 8 0 4 5



ART	BARCODE	ST.	PREZZO
07 22 60	4000270198069		10,90

CESTINO PANE/FRUTTA PLASTIFICATO
35X20CM KESPER

UV1	UV2	IMBALLO
1	5	1/5/30 CL



4 0 0 0 2 7 0 1 9 8 0 6 9



ART	BARCODE	ST.	PREZZO
07 22 75	4000270178498		2,75

CESTINI GRISSINI PLASTIFICATO
KESPER

UV1	UV2	IMBALLO
1	6	1/3/36 HT



4 0 0 0 2 7 0 1 7 8 4 9 8



ART	BARCODE	ST.	PREZZO
07 22 06	8004537722062		5,80

CESTINO PANE/FRUTTA ROTONDO PP Ø
24,5 X 8,5 CM EVA

UV1	UV2	IMBALLO
1	6	1/6/48 HT



8 0 0 4 5 3 7 7 2 2 0 6 2



ART	BARCODE	ST.	PREZZO
07 22 07	8004537722079		5,30

CESTINO PANE/FRUTTA OVALE PP 20 X
25 X 8.5 CM EVA

UV1	UV2	IMBALLO
1	6	1/6/72 HT



8 0 0 4 5 3 7 7 2 2 0 7 9



ART	BARCODE	ST.	PREZZO
07 22 08	8004537722086		6,95

CESTINO PANE/FRUTTA OVALE PP 30 X
23 X 9 CM EVA

UV1	UV2	IMBALLO
1	6	1/6/48 HT



8 0 0 4 5 3 7 7 2 2 0 8 6



ART	BARCODE	ST.	PREZZO
05 25 18	4000270197802		6,00

CESTINO PORTA-POSATE PLASTIFICATO
28X11.5X5.5 CM KESPER

UV1	UV2	IMBALLO
1	5	1/5/120 CL



4 0 0 0 2 7 0 1 9 7 8 0 2



ART	BARCODE	ST.	PREZZO
07 22 09	8004537722093		10,50

CESTINO PANE/FRUTTA RETTANGOLARE PP 35 X 20 X 8.5 CM EVA

UV1	UV2	IMBALLO
1	6	1/6/12 HT



8 0 0 4 5 3 7 7 2 2 0 9 3



ART	BARCODE	ST.	PREZZO
07 22 10	8004537722109		2,40

CESTINI GRISSINI PP Ø 10 X H 18 CM EVA

UV1	UV2	IMBALLO
1	6	1/6/48 HT



8 0 0 4 5 3 7 7 2 2 1 0 9



ART	BARCODE	ST.	PREZZO
07 22 87	4000270179273	A	17,50

CESTO PER CONFEZIONI VIMINI 45X28X25 CM KESPER

UV1	UV2	IMBALLO
1	10	1/10 HT



4 0 0 0 2 7 0 1 7 9 2 7 3



ART	BARCODE	ST.	PREZZO
07 22 88	4000270179280	A	19,90

CESTO PER CONFEZIONI VIMINI 50X32X25 CM KESPER

UV1	UV2	IMBALLO
1	10	1/10 HT



4 0 0 0 2 7 0 1 7 9 2 8 0



ART	BARCODE	ST.	PREZZO
07 22 98	4000270196003		21,00

CESTO PORTAPANE IN VIMINI 40X30X10/19CM KESPER

UV1	UV2	IMBALLO
1	4	1/4 HT



4 0 0 0 2 7 0 1 9 6 0 0 3



ART	BARCODE	ST.	PREZZO
07 22 99	4000270196010		35,00

CESTO PANE IN VIMINI 60X40X11/20CM KESPER

UV1	UV2	IMBALLO
1	4	1/4 HT



4 0 0 0 2 7 0 1 9 6 0 1 0



ART	BARCODE	ST.	PREZZO
07 22 91	4000270179044		6,90

CESTINO PANE VIMINI CON FODERA Ø30CM KESPER

UV1	UV2	IMBALLO
1	10	1/5/50 CL



4 0 0 0 2 7 0 1 7 9 0 4 4



ART	BARCODE	ST.	PREZZO
07 22 92	4000270179051		6,90

CESTINO PANE VIMINI CON FODERA 32X23CM KESPER

UV1	UV2	IMBALLO
1	10	1/5/50 AL



4 0 0 0 2 7 0 1 7 9 0 5 1



ART	BARCODE	ST.	PREZZO
07 22 55*	4000270196201	H	7,50

CESTO CARTA CON MANICI JUTA/BLU 20X20X13,5 CM KESPER

UV1	UV2	IMBALLO
1	3	1/3/72 HT



4 0 0 0 2 7 0 1 9 6 2 0 1



ART	BARCODE	ST.	PREZZO
07 22 56*	4000270196218	H	8,50

CESTO CARTA CON MANICI JUTA/BLU 32X22X14.5 CM KESPER

UV1	UV2	IMBALLO
1	3	1/3/48 HT



4 0 0 0 2 7 0 1 9 6 2 1 8



ART	BARCODE	ST.	PREZZO
07 22 36	8004537722369		4,80

CESTINO ROTONDO IN CARTA LAVABILE Ø 15 X 14 CM EVA

UV1	UV2	IMBALLO
1	10	1/10/200 PH



8 0 0 4 5 3 7 7 2 2 3 6 9



ART	BARCODE	ST.	PREZZO
07 22 37	8004537722376		5,30

CESTINO ROTONDO IN CARTA LAVABILE Ø 16 X 20 CM EVA

UV1	UV2	IMBALLO
1	10	1/10/200 PH



8 0 0 4 5 3 7 7 2 2 3 7 6



ART	BARCODE	ST.	PREZZO
07 22 35	8004537722352	H	4,50

CESTINO ROTONDO IN CARTA LAVABILE
Ø 10 X 21 CM EVA

UV1	UV2	IMBALLO
1	10	1/10/200 PH



8 0 0 4 5 3 7 7 2 2 3 5 2



ART	BARCODE	ST.	PREZZO
07 22 01	8004537722017		8,80

CESTINO DOPPIO FILO BIANCO Ø 24.5 X
12.5 CM EVA

UV1	UV2	IMBALLO
1	6	1/6 HT



8 0 0 4 5 3 7 7 2 2 0 1 7



ART	BARCODE	ST.	PREZZO
07 22 02	8004537722024		8,80

CESTINO DOPPIO FILO NERO Ø 24.5 X
12.5 CM EVA

UV1	UV2	IMBALLO
1	6	1/6 HT



8 0 0 4 5 3 7 7 2 2 0 2 4



ART	BARCODE	ST.	PREZZO
07 22 03	8004537722031		11,40

CESTINO DOPPIO FILO BIANCO Ø 29.5 X
15 CM EVA

UV1	UV2	IMBALLO
1	6	1/6 HT



8 0 0 4 5 3 7 7 2 2 0 3 1



ART	BARCODE	ST.	PREZZO
07 22 04	8004537722048		11,40

CESTINO DOPPIO FILO NERO Ø 29.5 X 15
CM EVA

UV1	UV2	IMBALLO
1	6	1/6 HT



8 0 0 4 5 3 7 7 2 2 0 4 8



ART	BARCODE	ST.	PREZZO
04 32 91	8004537432916		4,75

CASSETTA LEGNO 17X12X9CM

UV1	UV2	IMBALLO
1	12	1/1 BK



8 0 0 4 5 3 7 4 3 2 9 1 6



ART	BARCODE	ST.	PREZZO
04 32 92	8004537432923		5,20

CASSETTA LEGNO 25X17X10CM

UV1	UV2	IMBALLO
1	12	1/1 BK



8 0 0 4 5 3 7 4 3 2 9 2 3



ART	BARCODE	ST.	PREZZO
04 32 93	8004537432930		4,70

CASSETTA LEGNO 25X13X7CM

UV1	UV2	IMBALLO
1	12	1/1 BK



8 0 0 4 5 3 7 4 3 2 9 3 0



ART	BARCODE	ST.	PREZZO
04 32 77	4000270694837		8,90

CASSETTA IN LEGNO FSC 26X17X13CM
KESPER

UV1	UV2	IMBALLO
1	6	1/6 HT



4 0 0 0 2 7 0 6 9 4 8 3 7



ART	BARCODE	ST.	PREZZO
04 32 78	4000270694820		11,80

CASSETTA IN LEGNO FSC 30X20X16CM
KESPER

UV1	UV2	IMBALLO
1	6	1/6 HT



4 0 0 0 2 7 0 6 9 4 8 2 0



ART	BARCODE	ST.	PREZZO
04 32 79	4000270694806		18,90

CASSETTA 'NATURE' LEGNO FSC
40X30X20CM KESPER

UV1	UV2	IMBALLO
1	3	1/3 HT



4 0 0 0 2 7 0 6 9 4 8 0 6



ART	BARCODE	ST.	PREZZO
02 27 86	4000270699580	A	6,90

8 SOTTO-PADELLINE RACLETTE LEGNO
DI FAGGIO FSC 10CM KESPER

UV1	UV2	IMBALLO
1	10	1/10/100 SP



4 0 0 0 2 7 0 6 9 9 5 8 0



ART	BARCODE	ST.	PREZZO
07 21 12	4000270587467		9,40

SOTTOBICCHIERI 6 PEZZI BAMBU' FSC Ø 10 CM KESPER

UV1	UV2	IMBALLO
1	5	1/5/20 SL



4 0 0 0 2 7 0 5 8 7 4 6 7



ART	BARCODE	ST.	PREZZO
07 21 10	4000270627477		1,15

SOTTOBICCHIERI 6 PEZZI SUGHERO Ø 10 CM KESPER

UV1	UV2	IMBALLO
1	10	1/10/160 SP



4 0 0 0 2 7 0 6 2 7 4 7 7



ART	BARCODE	ST.	PREZZO
07 21 11	4000270627484		1,15

SOTTOBICCHIERI 6 PEZZI SUGHERO 10X10 CM KESPER

UV1	UV2	IMBALLO
1	10	1/10/160 SP



4 0 0 0 2 7 0 6 2 7 4 8 4



ART	BARCODE	ST.	PREZZO
07 22 80	4000270627545		2,00

SOTTOPENTOLA IN SUGHERO Ø20CM KESPER

UV1	UV2	IMBALLO
1	10	1/10/80 SP



4 0 0 0 2 7 0 6 2 7 5 4 5



ART	BARCODE	ST.	PREZZO
07 22 81	4000270627521		3,60

SOTTOPENTOLA IN SUGHERO Ø26CM KESPER

UV1	UV2	IMBALLO
1	10	1/10/60 SP



4 0 0 0 2 7 0 6 2 7 5 2 1



ART	BARCODE	ST.	PREZZO
07 22 79	4000270627507		1,90

SOTTOPENTOLA IN SUGHERO 20 X 20 CM KESPER

UV1	UV2	IMBALLO
1	10	1/10/80 SP



4 0 0 0 2 7 0 6 2 7 5 0 7



ART	BARCODE	ST.	PREZZO
07 22 85	4000270587405		4,40

SOTTOPENTOLA IN BAMBU' FSC Ø19CM KESPER

UV1	UV2	IMBALLO
1	10	1/10 SL



4 0 0 0 2 7 0 5 8 7 4 0 5



ART	BARCODE	ST.	PREZZO
07 22 86	4000270587412		4,30

SOTTOPENTOLA BAMBU' FSC 19X19 KESPER

UV1	UV2	IMBALLO
1	10	1/5 SL



4 0 0 0 2 7 0 5 8 7 4 1 2



ART	BARCODE	ST.	PREZZO
04 19 58*	8004537419580	H	6,90

PORTAFRUTTA FILO ROSSO Ø26CM EVA

UV1	UV2	IMBALLO
1	5	1/20 HT



8 0 0 4 5 3 7 4 1 9 5 8 0



ART	BARCODE	ST.	PREZZO
04 19 68	8004537419689		5,45

CAMPANA PARAMOSCHE FILO ASSORTITO Ø35CM EVA

UV1	UV2	IMBALLO
1	6	1/6/24 HT



8 0 0 4 5 3 7 4 1 9 6 8 9



ART	BARCODE	ST.	PREZZO
04 19 67	8004537419672		4,35

CAMPANA PARAMOSCHE FILO ASSORTITO Ø30CM EVA

UV1	UV2	IMBALLO
1	6	1/6/48 HT



8 0 0 4 5 3 7 4 1 9 6 7 2



ART	BARCODE	ST.	PREZZO
04 19 63	8004537419634		2,90

CAMPANA PARAMOSCHE PE 40 CM EVA

UV1	UV2	IMBALLO
1	24	1/12/240 PH



8 0 0 4 5 3 7 4 1 9 6 3 4



ART	BARCODE	ST.	PREZZO
04 19 61	8004537419610		2,40

CAMPANA PARAMOSCHE PE 30 CM EVA

UV1	UV2	IMBALLO
1	12	1/12/300 PH



8 0 0 4 5 3 7 4 1 9 6 1 0



ART	BARCODE	ST.	PREZZO
04 24 62	8004537424621	H	14,50

PORTARIFIUTI DA TAVOLA ACCIAIO
INOSSIDABILE 13X17,5CM EVA

UV1	UV2	IMBALLO
1	12	1/12 PB



8 0 0 4 5 3 7 4 2 4 6 2 1



ART	BARCODE	ST.	PREZZO
04 24 63	8004537424638		14,25

PORTARIFIUTI DA TAVOLA ACCIAIO
INOSSIDABILE 12CM EVA

UV1	UV2	IMBALLO
1	12	1/12/24 BX



8 0 0 4 5 3 7 4 2 4 6 3 8



ART	BARCODE	ST.	PREZZO
04 24 66	4021322816533		3,90

PORTARIFIUTI DA TAVOLA SAN ROSSO
11CM KAYSER

UV1	UV2	IMBALLO
1	10	1/5/215 BK



4 0 2 1 3 2 2 8 1 6 5 3 3



ART	BARCODE	ST.	PREZZO
04 24 65	4021322816526		3,90

PORTARIFIUTI DA TAVOLA SAN BEIGE
11CM KAYSER

UV1	UV2	IMBALLO
1	10	1/5/215 BK



4 0 2 1 3 2 2 8 1 6 5 2 6



ART	BARCODE	ST.	PREZZO
04 24 64	4021322816519		3,90

PORTARIFIUTI DA TAVOLA SAN BIANCO
11CM KAYSER

UV1	UV2	IMBALLO
1	10	1/5/215 BK



4 0 2 1 3 2 2 8 1 6 5 1 9



ART	BARCODE	ST.	PREZZO
04 33 19	4000270699023		1,00

200 STUZZICADENTI FSC IN CONFEZIONE
TRASPARENTE 65MM KESPER

UV1	UV2	IMBALLO
1	12	1/12/240 AB



4 0 0 0 2 7 0 6 9 9 0 2 3



ART	BARCODE	ST.	PREZZO
10 16 05	4004094526268	H	2,40

1000 STUZZICADENTI FINGERFOOD
BAMBU 65MM WESTMARK

UV1	UV2	IMBALLO
1	4	1/4/100 HB



4 0 0 4 0 9 4 5 2 6 2 6 8



ART	BARCODE	ST.	PREZZO
10 16 02	4004094525476	A	2,80

70 STICKS PER GRILL E FINGERFOOD
BAMBU 15CM WESTMARK

UV1	UV2	IMBALLO
1	4	1/4/100 PH



4 0 0 4 0 9 4 5 2 5 4 7 6



ART	BARCODE	ST.	PREZZO
10 16 06	4000270699269	A	1,30

50 STICKS PER PARTY E FINGERFOOD
BAMBU FSC 18CM KESPER

UV1	UV2	IMBALLO
1	6	1/6/96 PH



4 0 0 0 2 7 0 6 9 9 2 6 9



ART	BARCODE	ST.	PREZZO
04 18 13	4004094207044		3,65

6 PORTAUOVA 'TRI' PS Ø 10,6 CM
WESTMARK

UV1	UV2	IMBALLO
1	11	1/22 SP



4 0 0 4 0 9 4 2 0 7 0 4 4



ART	BARCODE	ST.	PREZZO
04 17 98	4004094206276		2,75

3 PORTAUOVA 'PUNTO' SAN Ø 10 CM
WESTMARK

UV1	UV2	IMBALLO
1	5	1/5/30 HB



4 0 0 4 0 9 4 2 0 6 2 7 6



ART	BARCODE	ST.	PREZZO
04 18 23	7611264805015		14,60

TAGLIGUSCIO PER UOVA ALLA COQUE
INOX 'CRACK-IT' MOHA

UV1	UV2	IMBALLO
1	12	1/12/48 HB



7 6 1 1 2 6 4 8 0 5 0 1 5



x50

ART	BARCODE	ST.	PREZZO
04 07 73	8004537407730	A	0,85

FERMATOVAGLIE A MOLLA NICHELATI IN
CONF. 50 PZ EVA

UV1	UV2	IMBALLO
50	300	50/300 LB



8 0 0 4 5 3 7 4 0 7 7 3 0



ART	BARCODE	ST.	PREZZO
04 07 74	8004537407747	A	4,30

4 FERMATOVAGLIE A MOLLE NICHELATE
EVA

UV1	UV2	IMBALLO
1	6	1/6/60 BC



8 0 0 4 5 3 7 4 0 7 7 4 7



ART	BARCODE	ST.	PREZZO
04 07 67	8004537407679		0,60

FERMATOVAGLIE ACCIAIO INOX IN
CONF. 100 PZ EVA

UV1	UV2	IMBALLO
100	500	100/1000 BX



8 0 0 4 5 3 7 4 0 7 6 7 9



ART	BARCODE	ST.	PREZZO
04 07 69	8004537407693		3,00

4 FERMATOVAGLIE ACCIAIO
INOSSIDABILE EVA

UV1	UV2	IMBALLO
1	12	1/12/192 BC



8 0 0 4 5 3 7 4 0 7 6 9 3



ART	BARCODE	ST.	PREZZO
04 54 15	8004537454154		2,55

4 FERMATOVAGLIE ABS BIANCO EVA

UV1	UV2	IMBALLO
1	6	1/6/108 BC



8 0 0 4 5 3 7 4 5 4 1 5 4



ART	BARCODE	ST.	PREZZO
04 54 16	8004537454161		2,70

4 FERMATOVAGLIE TRASPARENTE EVA

UV1	UV2	IMBALLO
1	6	1/6/108 BC



8 0 0 4 5 3 7 4 5 4 1 6 1



ART	BARCODE	ST.	PREZZO
04 07 75	8004537407754		2,85

4 FERMATOVAGLIE PC TRASPARENTE
EVA

UV1	UV2	IMBALLO
1	6	1/6/108 BC



8 0 0 4 5 3 7 4 0 7 7 5 4



ART	BARCODE	ST.	PREZZO
04 04 22	4000270772016		10,70

VASSOIO ANTISCIVOLO 'NERO'
46X32X4,5CM KESPER

UV1	UV2	IMBALLO
1	5	1/5/20 AL



4 0 0 0 2 7 0 7 7 2 0 1 6



ART	BARCODE	ST.	PREZZO
04 04 13	4000270772207	A	7,20

VASSOIO ANTISCIVOLO 'BIANCO'
35X26X2 CM KESPER

UV1	UV2	IMBALLO
1	5	1/5/20 AL



4 0 0 0 2 7 0 7 7 2 2 0 7



ART	BARCODE	ST.	PREZZO
04 04 14	4000270772214		7,20

VASSOIO ANTISCIVOLO 'NERO' 35X26X2
CM KESPER

UV1	UV2	IMBALLO
1	5	1/5/20 AL



4 0 0 0 2 7 0 7 7 2 2 1 4

Servizi Piatti Posate Tazze



ART	BARCODE	ST.	PREZZO
05 03 90	4004094135965		6,90

**COLTELLO BURRO ACCIAIO
INOSSIDABILE 22 CM WESTMARK**

UV1	UV2	IMBALLO
1	6	1/6/48 HB



4 0 0 4 0 9 4 1 3 5 9 6 5



ART	BARCODE	ST.	PREZZO
05 01 20	8011126040353		2,90

**3 CUCCHIAI TAVOLA ACCIAIO
INOSSIDABILE 'HOTEL' GNALI**

UV1	UV2	IMBALLO
1	12	1/120 CD



8 0 1 1 1 2 6 0 4 0 3 5 3



ART	BARCODE	ST.	PREZZO
05 01 21	8011126030354		2,90

**3 FORCHETTE TAVOLA ACCIAIO
INOSSIDABILE 'HOTEL' GNALI**

UV1	UV2	IMBALLO
1	12	1/120 CD



8 0 1 1 1 2 6 0 3 0 3 5 4



ART	BARCODE	ST.	PREZZO
05 01 22	8011126010165		5,80

**2 COLTELLI TAVOLA ACCIAIO
INOSSIDABILE 'HOTEL' GNALI**

UV1	UV2	IMBALLO
1	12	1/120 CD



8 0 1 1 1 2 6 0 1 0 1 6 5



ART	BARCODE	ST.	PREZZO
05 01 23	8011126090358		3,80

**6 CUCCHIAINI CAFFE' ACCIAIO
INOSSIDABILE 'HOTEL' GNALI**

UV1	UV2	IMBALLO
1	12	1/120 CD



8 0 1 1 1 2 6 0 9 0 3 5 8



ART	BARCODE	ST.	PREZZO
05 01 24	8011126100354		3,60

**6 CUCCHIAINI MOKA ACCIAIO
INOSSIDABILE 'HOTEL' GNALI**

UV1	UV2	IMBALLO
1	12	1/120 CD



8 0 1 1 1 2 6 1 0 0 3 5 4



ART	BARCODE	ST.	PREZZO
05 01 25	8011126180356		4,40

**6 FORCHETTA DOLCE ACCIAIO
INOSSIDABILE 'HOTEL' GNALI**

UV1	UV2	IMBALLO
1	12	1/144 CD



8 0 1 1 1 2 6 1 8 0 3 5 6



ART	BARCODE	ST.	PREZZO
05 01 26	8011126220359		4,40

**6 CUCCHIAI GELATO ACCIAIO
INOSSIDABILE 'HOTEL' GNALI**

UV1	UV2	IMBALLO
1	12	1/144 CD



8 0 1 1 1 2 6 2 2 0 3 5 9



ART	BARCODE	ST.	PREZZO
05 01 27	8011126230358		5,30

**6 CUCCHIAINI BIBITA ACCIAIO
INOSSIDABILE 'HOTEL' GNALI**

UV1	UV2	IMBALLO
1	12	1/120 CD



8 0 1 1 1 2 6 2 3 0 3 5 8



ART	BARCODE	ST.	PREZZO
05 01 92	4006974660499		99,90

**60 PEZZI CONFEZIONE TAVOLA INOX
18/10 'BAGUETTE' JUSTINUS**

UV1	UV2	IMBALLO
1	2	1/5 PB



4 0 0 6 9 7 4 6 6 0 4 9 9



ART	BARCODE	ST.	PREZZO
05 01 93	4006974630645		49,90

**30 PEZZI CONFEZIONE TAVOLA INOX
18/10 'LEVEL' JUSTINUS**

UV1	UV2	IMBALLO
1	2	1/5/10 PB



4 0 0 6 9 7 4 6 3 0 6 4 5



ART	BARCODE	ST.	PREZZO
05 14 56	4006974110154		10,50

**4 PEZZI SERVIZIO POSATE BAMBINI
'ANIMALI' INOX JUSTINUS**

UV1	UV2	IMBALLO
1	5	1/20 WB



4 0 0 6 9 7 4 1 1 0 1 5 4



ART	BARCODE	ST.	PREZZO
05 14 51	4006974110192		10,50

4 PEZZI SERVIZIO POSATE BAMBINI 'RANA' INOX JUSTINUS

UV1	UV2	IMBALLO
1	5	1/24 WB



4 0 0 6 9 7 4 1 1 0 1 9 2



ART	BARCODE	ST.	PREZZO
05 14 52	4006974110024		10,50

4 PEZZI SERVIZIO POSATE BAMBINI 'HAPPY DOG' INOX JUSTINUS

UV1	UV2	IMBALLO
1	5	1/24 WB



4 0 0 6 9 7 4 1 1 0 0 2 4



ART	BARCODE	ST.	PREZZO
04 01 32	7611264507551	A	15,90

CUCCHIAIO 'SERVIZIO' ACCIAIO INOSSID/SILICONE 30.8X7 CM MOHA

UV1	UV2	IMBALLO
1	6	1/6/48 SL



7 6 1 1 2 6 4 5 0 7 5 5 1



ART	BARCODE	ST.	PREZZO
04 01 33	7611264507988	A	15,90

CUCCHIAIO 'RISO' ACCIAIO INOSSID/SILICONE 24X7 CM MOHA

UV1	UV2	IMBALLO
1	6	1/6/48 SL



7 6 1 1 2 6 4 5 0 7 9 8 8



ART	BARCODE	ST.	PREZZO
05 03 71	8004537503715		2,70

CUCCHIAIO MARMELLATA ACCIAIO INOSSIDABILE 18/8 16CM EVA

UV1	UV2	IMBALLO
1	12	1/12/360 CD



8 0 0 4 5 3 7 5 0 3 7 1 5



ART	BARCODE	ST.	PREZZO
05 03 72	8004537503722		3,20

CUCCHIAIO MIELE ACCIAIO INOSSIDABILE 18/8 14CM EVA

UV1	UV2	IMBALLO
1	12	1/12/360 PG



8 0 0 4 5 3 7 5 0 3 7 2 2



ART	BARCODE	ST.	PREZZO
04 33 18	4000270698606		1,85

SPIRALE MIELE LEGNO FAGGIO FSC 16CM KEPSEK

UV1	UV2	IMBALLO
1	10	1/10/70 CD



4 0 0 0 2 7 0 6 9 8 6 0 6



ART	BARCODE	ST.	PREZZO
04 18 18	4004094208270	A	2,90

6 CUCCHIAI COCKTAIL ASSORTITI SAN 22,5CM WESTMARK

UV1	UV2	IMBALLO
1	10	1/10/70 CD



4 0 0 4 0 9 4 2 0 8 2 7 0



ART	BARCODE	ST.	PREZZO
04 18 27	4021322029919		2,00

6 CUCCHIAIO FORMAGGIO ACRILICO TRASPARENTE 13CM KAYSER

UV1	UV2	IMBALLO
1	10	1/10/150 PG



4 0 2 1 3 2 2 0 2 9 9 1 9



ART	BARCODE	ST.	PREZZO
04 18 24	4021322010016		1,80

6 CUCCHIAINI UOVA SAN TRASPARENTE 13CM KAYSER

UV1	UV2	IMBALLO
1	10	1/10/150 PG



4 0 2 1 3 2 2 0 1 0 0 1 6



ART	BARCODE	ST.	PREZZO
04 18 19	4021322089937		1,80

6 CUCCHIAI UOVA PS COLORATI 13CM KAYSER

UV1	UV2	IMBALLO
1	10	1/10/150 PG



4 0 2 1 3 2 2 0 8 9 9 3 7



ART	BARCODE	ST.	PREZZO
04 18 82	4021322027342		2,10

POSATE INSALATA ACRILICO 22CM KAYSER

UV1	UV2	IMBALLO
1	10	1/300 PG



4 0 2 1 3 2 2 0 2 7 3 4 2



ART	BARCODE	ST.	PREZZO
04 18 83	4021322228138		3,50

POSATE INSALATA ACRILICO 28CM
KAYSER

UV1	UV2	IMBALLO
1	10	1/10/150 PG



4 0 2 1 3 2 2 2 8 1 3 8



ART	BARCODE	ST.	PREZZO
04 18 84	4004094209277		4,90

POSATE INSALATA "BUBBLES" SAN
27,5CM WESTMARK

UV1	UV2	IMBALLO
1	6	1/6/60 CD



4 0 0 4 0 9 4 2 0 9 2 7 7



ART	BARCODE	ST.	PREZZO
04 18 85	4021322203708		3,60

MESTOLO CON BECCO ACRILICO 35CM
KAYSER

UV1	UV2	IMBALLO
1	10	1/200 PG



4 0 2 1 3 2 2 2 0 3 7 0 8



ART	BARCODE	ST.	PREZZO
04 20 76	4004094125577	A	4,70

2 PINZE BUFFET SET PP 2X25.5 CM
WESTMARK

UV1	UV2	IMBALLO
1	6	1/6/36 CD



4 0 0 4 0 9 4 1 2 5 5 7 7



ART	BARCODE	ST.	PREZZO
05 25 28	8004537525281		9,40

SCOLAPOSATE ACCIAIO INOSSIDABILE
12 CM EVA

UV1	UV2	IMBALLO
1	6	1/6/24 PB



8 0 0 4 5 3 7 5 2 5 2 8 1



ART	BARCODE	ST.	PREZZO
05 25 05	9002427646022	A	6,95

PORTAPOSATE DOPPIO PP BIANCO
39X29X7 CM TEKO PLASTIC

UV1	UV2	IMBALLO
1	6	1/12 BK



9 0 0 2 4 2 7 6 4 6 0 2 2



ART	BARCODE	ST.	PREZZO
04 19 81	7610859059987		11,20

SCOLAPIATTI+VASSOIO 'GEOMETRIC' PP
39,5X39,5X8,5 CM ROTHO

UV1	UV2	IMBALLO
1	3	1/3 BK



7 6 1 0 8 5 9 0 5 9 9 8 7



ART	BARCODE	ST.	PREZZO
05 25 11	4000270280856		27,50

PORTAPOSATE ALLUNGABILE ACACIA
FSC 35-58X43X6CM KESPER

UV1	UV2	IMBALLO
1	3	1/3 SL



4 0 0 0 2 7 0 2 8 0 8 5 6



ART	BARCODE	ST.	PREZZO
05 25 10	4000270580727		12,50

2 DIVISORI REGOLABILI CASSETTI
BAMBU FSC 56X6X1,6 CM KESPER

UV1	UV2	IMBALLO
1	3	1/3/12 SP



4 0 0 0 2 7 0 5 8 0 7 2 7



ART	BARCODE	ST.	PREZZO
05 25 12	4000270581861		21,50

PORTAPOSATE ALLUNGABILE BAMBU
FSC 26-49X43X6CM KESPER

UV1	UV2	IMBALLO
1	3	1/3 SP



4 0 0 0 2 7 0 5 8 1 8 6 1



ART	BARCODE	ST.	PREZZO
05 25 13	4000270581878		15,90

PORTAPOSATE CON 2 MANICI BAMBU
FSC 38X32X4CM KESPER

UV1	UV2	IMBALLO
1	3	1/3 SL



4 0 0 0 2 7 0 5 8 1 8 7 8



ART	BARCODE	ST.	PREZZO
04 32 83*	4000270708206	H	29,80

CASSETTINO BAMBU' FSC 9 SCOMPARTI
37X31,5X9,5CM KESPER

UV1	UV2	IMBALLO
1	3	1/3 SP



4 0 0 0 2 7 0 7 0 8 2 0 6



ART	BARCODE	ST.	PREZZO
05 25 21	4001515162012	A	2,75

PORTAPOSATE PP 33X26 CM OKT

UV1	UV2	IMBALLO
1	5	1/1 BK



4 0 0 1 5 1 5 1 6 2 0 1 2



ART	BARCODE	ST.	PREZZO
05 25 08	7610859153180		8,55

PORTAPOSATE DOPPIO 'BASIC' PP 39X32X7 CM ROTHO

UV1	UV2	IMBALLO
1	6	1/6 SP



7 6 1 0 8 5 9 1 5 3 1 8 0



ART	BARCODE	ST.	PREZZO
05 25 09	7610859153203		10,30

PORTAPOSATE ALLUNGABILE 'DOMINO' PP 39X34/51X5 CM ROTHO

UV1	UV2	IMBALLO
1	6	1/6 SP



7 6 1 0 8 5 9 1 5 3 2 0 3



ART	BARCODE	ST.	PREZZO
04 19 83	9002427355023		9,60

SCOLAPIATTI CON VASSOIO BIANCO 45.5X35X10 CM TEKO PLASTIC

UV1	UV2	IMBALLO
1	5	1/5 BK



9 0 0 2 4 2 7 3 5 5 0 2 3



ART	BARCODE	ST.	PREZZO
05 25 40	7610859058324		0,70

PORTAPOSATE 'BASIC MODULAR' TRASP. PP 8X8X5 CM ROTHO

UV1	UV2	IMBALLO
1	10	1/10 BK



7 6 1 0 8 5 9 0 5 8 3 2 4



ART	BARCODE	ST.	PREZZO
05 25 41	7610859058331		0,85

PORTAPOSATE 'BASIC MODULAR' TRASP. PP 15X8X5 CM ROTHO

UV1	UV2	IMBALLO
1	10	1/10 BK



7 6 1 0 8 5 9 0 5 8 3 3 1



ART	BARCODE	ST.	PREZZO
05 25 42	7610859058348		1,00

PORTAPOSATE 'BASIC MODULAR' TRASP. PP 23X8X5 CM ROTHO

UV1	UV2	IMBALLO
1	10	1/10 BK



7 6 1 0 8 5 9 0 5 8 3 4 8



ART	BARCODE	ST.	PREZZO
05 25 43	7610859058355		1,20

PORTAPOSATE 'BASIC MODULAR' TRASP. PP 30X8X5 CM ROTHO

UV1	UV2	IMBALLO
1	10	1/10 BK



7 6 1 0 8 5 9 0 5 8 3 5 5



ART	BARCODE	ST.	PREZZO
05 25 44	7610859058362		1,60

PORTAPOSATE 'BASIC MODULAR' TRASP. PP 38X8X5 CM ROTHO

UV1	UV2	IMBALLO
1	10	1/10 BK



7 6 1 0 8 5 9 0 5 8 3 6 2



ART	BARCODE	ST.	PREZZO
05 25 45	7610859058379		1,60

PORTAPOSATE 'BASIC MODULAR' TRASP. PP 23X15X5 CM ROTHO

UV1	UV2	IMBALLO
1	10	1/10 BK



7 6 1 0 8 5 9 0 5 8 3 7 9



ART	BARCODE	ST.	PREZZO
05 25 46	7610859058386		2,30

PORTAPOSATE 'BASIC MODULAR' TRASP. PP 38X15X5 CM ROTHO

UV1	UV2	IMBALLO
1	10	1/10 BK



7 6 1 0 8 5 9 0 5 8 3 8 6



ART	BARCODE	ST.	PREZZO
07 09 05	8004537709056	H	3,90

COPPETTA QUADRATA BIANCO LUCIDO 10X10X9,5CM EVA

UV1	UV2	IMBALLO
4	24	1/4/48 BK



8 0 0 4 5 3 7 7 0 9 0 5 6



ART	BARCODE	ST.	PREZZO
07 09 06*	8004537709063	H	3,90

**COPPETTA QUADRATA NERO OPACO
10X10X9,5CM EVA**

UV1	UV2	IMBALLO
4	24	1/4/48 BK



8 0 0 4 5 3 7 7 0 9 0 6 3



ART	BARCODE	ST.	PREZZO
07 09 20*	8004537709209	H	3,60

**COPPETTA SOJA 2 SCOMPARTI BIANCO
LUCIDO 14X8CM EVA**

UV1	UV2	IMBALLO
6	24	1/6/72 BK



8 0 0 4 5 3 7 7 0 9 2 0 9



ART	BARCODE	ST.	PREZZO
07 09 24*	8004537709247	H	13,50

PIATTO BIANCO LUCIDO 37X12CM EVA

UV1	UV2	IMBALLO
3	12	1/3/12 BK



8 0 0 4 5 3 7 7 0 9 2 4 7



ART	BARCODE	ST.	PREZZO
07 09 25*	8004537709254	H	13,50

PIATTO NERO OPACO 37X12CM EVA

UV1	UV2	IMBALLO
3	12	1/3/12 BK



8 0 0 4 5 3 7 7 0 9 2 5 4



ART	BARCODE	ST.	PREZZO
07 09 27*	8004537709278	H	5,50

**PIATTO PIANO NERO OPACO 22X15CM
EVA**

UV1	UV2	IMBALLO
6	24	1/6/24 BK



8 0 0 4 5 3 7 7 0 9 2 7 8



ART	BARCODE	ST.	PREZZO
07 09 63	8004537709636	A	2,60

**10 PAIA DI CHOPSTICKS BAMBU' 26CM
EVA**

UV1	UV2	IMBALLO
1	10	1/100 HB



8 0 0 4 5 3 7 7 0 9 6 3 6



ART	BARCODE	ST.	PREZZO
08 95 10	4009290115513		2,20

**MUG PORCELLANA BIANCA 280ML
IMPILABILE**

UV1	UV2	IMBALLO
12	24	1/12/36 BK



4 0 0 9 2 9 0 1 1 5 5 1 3



ART	BARCODE	ST.	PREZZO
08 12 49	4006344060713	A	4,25

**PIATTINO TE' 'SOLINO' BIANCO 16CM
RITZENHOFF&BREKER**

UV1	UV2	IMBALLO
6	36	1/6/36 BK



4 0 0 6 3 4 4 0 6 0 7 1 3



ART	BARCODE	ST.	PREZZO
07 59 91	4000270382307		2,50

**PIATTO "NATALE" METALLO ASSORTITO
Ø25,5CM KESPER**

UV1	UV2	IMBALLO
1	12	1/12 BK



4 0 0 0 2 7 0 3 8 2 3 0 7



ART	BARCODE	ST.	PREZZO
07 59 92	4000270894459		3,30

**PIATTO PIANO "NATALE" METALLO Ø
32CM KESPER**

UV1	UV2	IMBALLO
1	12	1/12 BK



4 0 0 0 2 7 0 8 9 4 4 5 9



ART	BARCODE	ST.	PREZZO
08 17 01	4004094697548	A	5,90

**CIOTOLA RETTANGOLARE 4PZ 'TAPAS'
CERAMICA BIANCA WESTMARK**

UV1	UV2	IMBALLO
1	3	1/3/48 PG



4 0 0 4 0 9 4 6 9 7 5 4 8



ART	BARCODE	ST.	PREZZO
08 17 02	4004094014239	A	5,90

**CIOTOLA QUADRATA 4 PZ 'TAPAS'
CERAMICA BIANCA WESTMARK**

UV1	UV2	IMBALLO
1	3	1/3/48 PG



4 0 0 4 0 9 4 0 1 4 2 3 9



ART	BARCODE	ST.	PREZZO
08 17 03	4004094014246	A	5,90

**CIOTOLA ROTONDA 4 PZ 'TAPAS'
CERAMICA BIANCA WESTMARK**

UV1	UV2	IMBALLO
1	3	1/3/48 PG



4 0 0 4 0 9 4 0 1 4 2 4 6



ART	BARCODE	ST.	PREZZO
08 17 04	4004094014253	A	5,90

**CIOTOLA A GOCCIA 4 PZ 'TAPAS'
CERAMICA BIANCA WESTMARK**

UV1	UV2	IMBALLO
1	3	1/3/48 PG



4 0 0 4 0 9 4 0 1 4 2 5 3



ART	BARCODE	ST.	PREZZO
08 17 05	4004094697661	A	3,95

**CUCCHIAIO 6 PZ 'TAPAS' CERAMICA
BIANCA WESTMARK**

UV1	UV2	IMBALLO
1	3	1/3/48 HB



4 0 0 4 0 9 4 6 9 7 6 6 1



ART	BARCODE	ST.	PREZZO
09 06 01	8004537906011		8,30

**2 BICCHIERI ESPRESSO VETRO
BOROSIL. DOPPIA PARETE 80ML EVA**

UV1	UV2	IMBALLO
1	6	1/24 PB



8 0 0 4 5 3 7 9 0 6 0 1 1



ART	BARCODE	ST.	PREZZO
09 06 02	8004537906028		11,00

**2 BICCHIERI CAPPUCCINO VETRO
BOROS. DOPPIA PARETE 200ML EVA**

UV1	UV2	IMBALLO
1	6	1/24 PB



8 0 0 4 5 3 7 9 0 6 0 2 8



ART	BARCODE	ST.	PREZZO
09 06 03	8004537906035		14,20

**2 BICCHIERI TE/LATTE VETRO BOROS.
DOPPIA PARETE 400ML EVA**

UV1	UV2	IMBALLO
1	6	1/24 PB



8 0 0 4 5 3 7 9 0 6 0 3 5



ART	BARCODE	ST.	PREZZO
09 06 04	8004537906042		11,60

**2 BICCHIERI VETRO BOROSILICATO
DOPPIA PARETE 250ML EVA**

UV1	UV2	IMBALLO
1	6	1/24 PB



8 0 0 4 5 3 7 9 0 6 0 4 2



ART	BARCODE	ST.	PREZZO
09 06 05	8004537906059		16,50

**2 COPPE VETRO BOROSILICATO DOPPIA
PARETE 250ML EVA**

UV1	UV2	IMBALLO
1	6	1/24 PB



8 0 0 4 5 3 7 9 0 6 0 5 9



ART	BARCODE	ST.	PREZZO
09 06 06	8004537906066		12,30

**2 CIOTOLE MEZZA LUNA VETRO
BOROSIL DOPPIA PARETE 220ML EVA**

UV1	UV2	IMBALLO
1	6	1/24 PB



8 0 0 4 5 3 7 9 0 6 0 6 6



ART	BARCODE	ST.	PREZZO
09 06 07	8004537906073		11,40

**2 COPPETTE COCKTAIL VETRO BOROSIL
DOPPIA PARETE 200ML EVA**

UV1	UV2	IMBALLO
1	6	1/24 PB



8 0 0 4 5 3 7 9 0 6 0 7 3



ART	BARCODE	ST.	PREZZO
09 06 08	8004537906080		12,20

**2 SHOT PIPE VETRO BOROSILICATO
DOPPIA PARETE 170ML EVA**

UV1	UV2	IMBALLO
1	6	1/24 PB



8 0 0 4 5 3 7 9 0 6 0 8 0



ART	BARCODE	ST.	PREZZO
09 06 09	8004537906097		13,60

**2 SHOT PIPE VETRO BOROSILICATO
DOPPIA PARETE 210ML EVA**

UV1	UV2	IMBALLO
1	6	1/24 PB



8 0 0 4 5 3 7 9 0 6 0 9 7

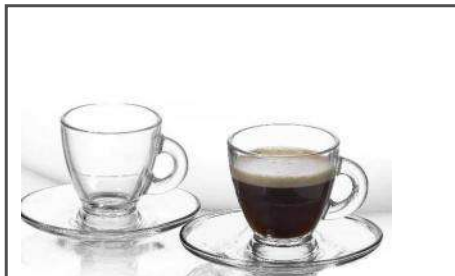

ART	BARCODE	ST.	PREZZO
09 07 11	4009290138741		5,90

2 TAZZINE ESPRESSO+PIATTINO 'ROMA'
VETRO 95ML

UV1	UV2	IMBALLO
1	12	1/12 PB



4 0 0 9 2 9 0 1 3 8 7 4 1



ART	BARCODE	ST.	PREZZO
09 07 12	4009290138765		6,80

2 TAZZE CAPPUCCINO+PIATTINO 'ROMA'
VETRO 255ML

UV1	UV2	IMBALLO
1	6	1/6 PB



4 0 0 9 2 9 0 1 3 8 7 6 5



ART	BARCODE	ST.	PREZZO
09 07 14	8593419184932	A	18,95

4 TAZZE CAPPUCCINO+PIATTINO
'PICCOLO' VETRO 250ML SIMAX

UV1	UV2	IMBALLO
1	3	1/12 PB



8 5 9 3 4 1 9 1 8 4 9 3 2



ART	BARCODE	ST.	PREZZO
01 27 17	8593419155901		8,20

2 BICCHIERI TE' "CHARME" 0,23L SIMAX

UV1	UV2	IMBALLO
1	6	1/6 PB



8 5 9 3 4 1 9 1 5 5 9 0 1



ART	BARCODE	ST.	PREZZO
09 07 01	8593419905261		1,55

BICCHIERE DA TE' SENZA MANICO
VETRO 0,2L SIMAX

UV1	UV2	IMBALLO
6	24	1/6 BK



8 5 9 3 4 1 9 9 0 5 2 6 1

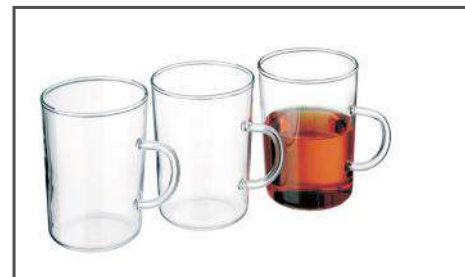

ART	BARCODE	ST.	PREZZO
09 07 03	8593419180200		2,15

BICCHIERE DA TE' + MANICO VETRO 0,2L
SIMAX

UV1	UV2	IMBALLO
6	24	1/6 BK



8 5 9 3 4 1 9 1 8 0 2 0 0



ART	BARCODE	ST.	PREZZO
01 27 13	8593419915642		9,60

2 BICCHIERI TE' CILINDRICI 0,3L SIMAX

UV1	UV2	IMBALLO
1	10	1/20 PB



8 5 9 3 4 1 9 9 1 5 6 4 2



ART	BARCODE	ST.	PREZZO
09 07 04	8593419185151		12,00

TISANIERA+FILTER+COPERCHIO 'LYRA'
VETRO 0,35L SIMAX

UV1	UV2	IMBALLO
1	6	1/6 PB



8 5 9 3 4 1 9 1 8 5 1 5 1



ART	BARCODE	ST.	PREZZO
08 95 14	4009290115995		3,10

MUG PORCELLANA ASSORTITA 'LINE'
330ML

UV1	UV2	IMBALLO
6	18	1/6/36 BK



4 0 0 9 2 9 0 1 1 5 9 9 5



ART	BARCODE	ST.	PREZZO
08 95 13	4009290135856		3,10

MUG PORCELLANA ASSORTITA
'CIVETTA' 330ML

UV1	UV2	IMBALLO
6	18	1/6/36 BK



4 0 0 9 2 9 0 1 3 5 8 5 6



ART	BARCODE	ST.	PREZZO
08 95 44	4009290143271	A	4,95

MUG PORCELLANA ASSORTITA 'GUF
NATALIZI' 370ML

UV1	UV2	IMBALLO
6	12	1/6/12 BK



4 0 0 9 2 9 0 1 4 3 2 7 1



ART	BARCODE	ST.	PREZZO
08 95 12	4009290134606		3,10

MUG PORCELLANA ASSORTITA 'RESI'
330ML

UV1	UV2	IMBALLO
6	18	1/6/36 BK



4 0 0 9 2 9 0 1 3 4 6 0 6



ART	BARCODE	ST.	PREZZO
08 95 46	4009290151016	A	4,95

MUG PORCELLANA "CERVO" ROSSO BORDEAUX 370ML

UV1	UV2	IMBALLO
1	6	1/6/12 BK



4 0 0 9 2 9 0 1 5 1 0 1 6



ART	BARCODE	ST.	PREZZO
08 95 47	4009290151092	A	6,95

SCODELLA MUESLI/DOLCI PORCELLANA "CERVO" BORDEAUX 14,5CM

UV1	UV2	IMBALLO
1	6	1/6/12 BK



4 0 0 9 2 9 0 1 5 1 0 9 2



ART	BARCODE	ST.	PREZZO
08 95 48	4009290150910		5,70

MUG PORCELLANA "CERVO" GRIGIO 370ML

UV1	UV2	IMBALLO
1	6	1/6/12 BK



4 0 0 9 2 9 0 1 5 0 9 1 0



ART	BARCODE	ST.	PREZZO
08 95 49	4009290150996		7,30

SCODELLA MUESLI/DOLCI PORCELLANA "CERVO" GRIGIO 14,5CM

UV1	UV2	IMBALLO
1	6	1/6/12 BK



4 0 0 9 2 9 0 1 5 0 9 9 6



ART	BARCODE	ST.	PREZZO
08 95 20	4009290139564		3,10

MUG PORCELLANA ANIMALI DEL BOSCO 330ML

UV1	UV2	IMBALLO
6	12	1/6/36 BK



4 0 0 9 2 9 0 1 3 9 5 6 4



ART	BARCODE	ST.	PREZZO
08 95 19	4009290115988		3,10

MUG PORCELLANA "CUORE DI CAFFE" ASSORTITO 330ML

UV1	UV2	IMBALLO
6	12	1/6/36 BK



4 0 0 9 2 9 0 1 1 5 9 8 8



ART	BARCODE	ST.	PREZZO
08 95 11	4009290042888		2,95

MUG CERAMICA BLU 'VIN BRULE' 200ML

UV1	UV2	IMBALLO
12	24	1/12/36 BK



4 0 0 9 2 9 0 0 4 2 8 8 8



ART	BARCODE	ST.	PREZZO
08 95 27	4009290149808	A	2,95

MUG PORCELLANA "HOME" ASSORTITA 330ML

UV1	UV2	IMBALLO
6	12	1/6/36 BK



4 0 0 9 2 9 0 1 4 9 8 0 8



ART	BARCODE	ST.	PREZZO
08 95 29	4009290167949		3,10

MUG PORCELLANA "CATS AND DOGS" ASSORTITA 320ML

UV1	UV2	IMBALLO
6	12	1/6/36 BK



4 0 0 9 2 9 0 1 6 7 9 4 9



ART	BARCODE	ST.	PREZZO
08 95 30	4009290154475	A	2,95

MUG PORCELLANA "VRON" ASSORTITA 330ML

UV1	UV2	IMBALLO
6	12	1/6/36 BK



4 0 0 9 2 9 0 1 5 4 4 7 5



ART	BARCODE	ST.	PREZZO
08 95 32	4009290162418	A	2,95

MUG PORCELLANA "FOREVER" ASSORTITA 320ML

UV1	UV2	IMBALLO
6	12	1/6/36 BK



4 0 0 9 2 9 0 1 6 2 4 1 8



ART	BARCODE	ST.	PREZZO
08 95 33	4009290115964		3,10

MUG PORCELLANA "TIME" ASSORTITA 330ML

UV1	UV2	IMBALLO
6	12	1/6/36 BK



4 0 0 9 2 9 0 1 1 5 9 6 4



ART	BARCODE	ST.	PREZZO
08 95 34	4009290165822		4,50
MUG PORCELLANA "CUP OF COFFEE" ASSORTITA 380ML			
UV1	UV2	IMBALLO	
6	12	1/6/36 BK	
 4 0 0 9 2 9 0 1 6 5 8 2 2			

**Bicchieri Caraffe Decanter Bottiglie
Vetro**



ART	BARCODE	ST.	PREZZO
07 18 44*	8004537718447	H	9,50

BOCCALE GRIGIO/BLU GRES 500ML

UV1	UV2	IMBALLO
1	6	1/6 BK



8 0 0 4 5 3 7 7 1 8 4 4 7



ART	BARCODE	ST.	PREZZO
09 01 61	8593401794187	A	9,90

DECANTER IN VETRO 31B05 1,2L

UV1	UV2	IMBALLO
1	6	1/6 PB



8 5 9 3 4 0 1 7 9 4 1 8 7



ART	BARCODE	ST.	PREZZO
09 08 17	4000270682872		12,50

7 PZ VASSOIO-GRAPPA LEGNO PINO
FSC+BICCHIERI 6X57CM KESPER

UV1	UV2	IMBALLO
1	5	1/5 SP



4 0 0 0 2 7 0 6 8 2 8 7 2



ART	BARCODE	ST.	PREZZO
09 08 16	4000270682766		17,50

9 PZ VASSOIO-GRAPPA LEGNO PINO
FSC+BICCHIERI 6X72CM KESPER

UV1	UV2	IMBALLO
1	5	1/5 SP



4 0 0 0 2 7 0 6 8 2 7 6 6



ART	BARCODE	ST.	PREZZO
09 08 20	4000270682803		15,90

9 PZ VASSOIO GRAPPA LEGNO PINO
FSC+BICCHIERI 17X40CM KESPER

UV1	UV2	IMBALLO
1	5	1/5 SP



4 0 0 0 2 7 0 6 8 2 8 0 3



ART	BARCODE	ST.	PREZZO
09 08 19	4000270682797	A	17,90

9 PZ VASSOIO GRAPPA FAGGIO
FSC+BICCHIERI 17X40CM KESPER

UV1	UV2	IMBALLO
1	5	1/5 SP



4 0 0 0 2 7 0 6 8 2 7 9 7



ART	BARCODE	ST.	PREZZO
09 08 12	8004537908121		5,00

6 BICCHIERINI CON MANICO 15ML
KESPER

UV1	UV2	IMBALLO
1	24	1/24 SP



8 0 0 4 5 3 7 9 0 8 1 2 1



ART	BARCODE	ST.	PREZZO
08 15 05	4006344182637	A	6,50

3 BICCHIERI BAMBINI 'PIRATA KLAUS'
VETRO 205ML RITZENHOFF

UV1	UV2	IMBALLO
1	6	1/6 CT



4 0 0 6 3 4 4 1 8 2 6 3 7



ART	BARCODE	ST.	PREZZO
09 07 80*	8435456408643	H	1,95

BICCHIERE VETRO 'CASUAL' 250CC IN
DISPLAY

UV1	UV2	IMBALLO
12	24	1/12/36 DB



8 4 3 5 4 5 6 4 0 8 6 4 3



ART	BARCODE	ST.	PREZZO
09 03 14	8001691857814		3,35

BOCCALE PER BIRRA 'BAYER' 0,5L
CERVE

UV1	UV2	IMBALLO
6	36	1/6 BK



8 0 0 1 6 9 1 8 5 7 8 1 4



ART	BARCODE	ST.	PREZZO
09 03 15	8001691856954		5,50

BOCCALE PER BIRRA 'BAYER' 1L CERVE

UV1	UV2	IMBALLO
6	36	1/6 BK



8 0 0 1 6 9 1 8 5 6 9 5 4



ART	BARCODE	ST.	PREZZO
09 03 22	4009290117418		16,60

6 BICCHIERI WEIZEN LISCI 0,3L VAN
WELL

UV1	UV2	IMBALLO
1	2	1/1 BX



4 0 0 9 2 9 0 1 1 7 4 1 8



ART	BARCODE	ST.	PREZZO
09 03 23	726502181336		12,20

6 BICCHIERI WEIZEN LISCI 0,5L VAN WELL

UV1	UV2	IMBALLO
1	2	1/1 BX



7 2 6 5 0 2 1 8 1 3 3 6



ART	BARCODE	ST.	PREZZO
09 12 91	4000753125193		3,60

CALICE GRAPPA 'GOURMET' 80ML BOHEMIA

UV1	UV2	IMBALLO
6	24	1/6/24 PB



4 0 0 0 7 5 3 1 2 5 1 9 3



ART	BARCODE	ST.	PREZZO
09 12 92	4000753125094		4,55

CALICE VINO 'GOURMET' 325ML BOHEMIA

UV1	UV2	IMBALLO
6	24	1/6/24 PB



4 0 0 0 7 5 3 1 2 5 0 9 4



ART	BARCODE	ST.	PREZZO
09 12 93	4000753125070		4,75

CALICE VINO 'GOURMET' 460ML BOHEMIA

UV1	UV2	IMBALLO
6	24	1/6/24 PB



4 0 0 0 7 5 3 1 2 5 0 7 0



ART	BARCODE	ST.	PREZZO
09 12 94	4000753125155		5,20

CALICE BORDEAUX 'GOURMET' 630ML BOHEMIA

UV1	UV2	IMBALLO
6	24	1/6/24 PB



4 0 0 0 7 5 3 1 2 5 1 5 5



ART	BARCODE	ST.	PREZZO
09 12 95	4000753125131		5,30

CALICE BURGUND 'GOURMET' 695ML BOHEMIA

UV1	UV2	IMBALLO
6	24	1/6/24 PB



4 0 0 0 7 5 3 1 2 5 1 3 1



ART	BARCODE	ST.	PREZZO
09 12 96	4000753125117		4,55

CALICE CHAMPAGNE 'GOURMET' 260ML BOHEMIA

UV1	UV2	IMBALLO
6	24	1/6/24 PB



4 0 0 0 7 5 3 1 2 5 1 1 7



ART	BARCODE	ST.	PREZZO
09 12 02	8593401799915	A	3,00

CALICE VINO ROSSO 'REBECCA' 460ML

UV1	UV2	IMBALLO
6	48	1/6/48 PB



8 5 9 3 4 0 1 7 9 9 9 1 5



ART	BARCODE	ST.	PREZZO
09 12 03	8593401799922	A	3,25

CALICE BORDEAUX 'REBECCA' 540ML

UV1	UV2	IMBALLO
6	48	1/6/48 BK



8 5 9 3 4 0 1 7 9 9 9 2 2



ART	BARCODE	ST.	PREZZO
09 12 04	8593401799939	A	3,50

CALICE BURGUNDER 'REBECCA' 590ML

UV1	UV2	IMBALLO
6	48	1/6/48 BK



8 5 9 3 4 0 1 7 9 9 9 3 9



ART	BARCODE	ST.	PREZZO
09 07 39	4000753156821	A	25,00

7 PEZZI SET BIBITA/ACQUA 'LIBERA' BOHEMIA

UV1	UV2	IMBALLO
1	2	1/1 PB



4 0 0 0 7 5 3 1 5 6 8 2 1



ART	BARCODE	ST.	PREZZO
09 19 13	8435456400647		11,60

4 BOTTIGLIA VETRO+TAPPO ERMETICO ASSORTITO 150 CC

UV1	UV2	IMBALLO
1	6	1/6 CT



8 4 3 5 4 5 6 4 0 0 6 4 7



ART	BARCODE	ST.	PREZZO
09 19 65	8435011141640		3,85

**BOTTIGLIA VETRO+TAPPO ERMETICO
GOCCIA 300CC**

UV1	UV2	IMBALLO
1	12	1/12 BK



8 4 3 5 0 1 1 1 4 1 6 4 0



ART	BARCODE	ST.	PREZZO
09 19 66	8435011141657		3,85

**BOTTIGLIA VETRO+TAPPO ERMETICO
ROTONDA 300CC**

UV1	UV2	IMBALLO
1	12	1/12 BK



8 4 3 5 0 1 1 1 4 1 6 5 7



ART	BARCODE	ST.	PREZZO
09 19 67	8435011141664		3,85

**BOTTIGLIA VETRO+TAPPO ERMETICO
QUADRA 300 CC**

UV1	UV2	IMBALLO
1	12	1/12 BK



8 4 3 5 0 1 1 1 4 1 6 6 4



ART	BARCODE	ST.	PREZZO
09 19 64	8435011141633		3,85

**BOTTIGLIA VETRO+TAPPO ERMETICO
PIRAMIDE 430 CC**

UV1	UV2	IMBALLO
1	12	1/12 BK



8 4 3 5 0 1 1 1 4 1 6 3 3



ART	BARCODE	ST.	PREZZO
09 19 20	8435011105338		3,70

**BOTTIGLIA VETRO+TAPPO SUGHERO
QUADRA 250 CC**

UV1	UV2	IMBALLO
1	6	1/6 BK



8 4 3 5 0 1 1 1 0 5 3 3 8



ART	BARCODE	ST.	PREZZO
09 19 15	8435456401996		8,50

**4 BOTTIGLIA VETRO+TAPPO SUGHERO
ASSORTITO 120 CC**

UV1	UV2	IMBALLO
1	6	1/6 CT



8 4 3 5 4 5 6 4 0 1 9 9 6



ART	BARCODE	ST.	PREZZO
09 19 14	8435456403792		13,05

**4 BOTTIGLIA VETRO+TAPPO SUGHERO
ASSORTITO 400 CC**

UV1	UV2	IMBALLO
1	6	1/6 CT



8 4 3 5 4 5 6 4 0 3 7 9 2



ART	BARCODE	ST.	PREZZO
09 19 23	8435011112114		3,10

**BOTTIGLIA VETRO+TAPPO SUGHERO
ROTONDA 350CC**

UV1	UV2	IMBALLO
1	12	1/12 BK



8 4 3 5 0 1 1 1 1 2 1 1 4



ART	BARCODE	ST.	PREZZO
09 19 25	8435011111841		3,10

**BOTTIGLIA VETRO+TAPPO SUGHERO
PIRAMIDE 350 CC**

UV1	UV2	IMBALLO
1	12	1/12 BK



8 4 3 5 0 1 1 1 1 1 8 4 1



ART	BARCODE	ST.	PREZZO
09 19 24	8435011112633		3,10

**BOTTIGLIA VETRO+TAPPO SUGHERO
RETTANG 400 CC**

UV1	UV2	IMBALLO
1	12	1/12 BK



8 4 3 5 0 1 1 1 1 2 6 3 3



ART	BARCODE	ST.	PREZZO
09 19 34	8435271255903	A	8,50

**3 BOTTIGLIE VETRO+TAPPO IN SUGHERO
IMPILABILI 275+300+300CC**

UV1	UV2	IMBALLO
1	6	1/6 CT



8 4 3 5 2 7 1 2 5 5 9 0 3



ART	BARCODE	ST.	PREZZO
09 19 70	8435011121796		13,50

BOTT+RUBINETTO 2000CC

UV1	UV2	IMBALLO
1	6	1/6 BK



8 4 3 5 0 1 1 1 2 1 7 9 6



ART	BARCODE	ST.	PREZZO
09 19 71	8435271228099	A	23,00

BOTT+RUBINETTO 5000CC

UV1	UV2	IMBALLO
1	6	1/1 BX



8 4 3 5 2 7 1 2 2 8 0 9 9



ART	BARCODE	ST.	PREZZO
09 19 73	8435456425381		17,00

CONTENITORE
VETRO+COPERCHIO+RUBINETTO

"AUTHENTIC" 4L

UV1	UV2	IMBALLO
1	2	1/1 BX



8 4 3 5 4 5 6 4 2 5 3 8 1



ART	BARCODE	ST.	PREZZO
09 19 72	8435271288277		23,50

CONTENITORE
VETRO+COPERCHIO+RUBINETTO

"AUTHENTIC" 6L

UV1	UV2	IMBALLO
1	3	1/1 BX



8 4 3 5 2 7 1 2 8 8 2 7 7



ART	BARCODE	ST.	PREZZO
09 19 74	8435271260419	A	25,50

CONTENITORE ESAGONALE+COPERCHIO
VETRO +RUBINETTO 6,5L

UV1	UV2	IMBALLO
1	2	1/1 BX



8 4 3 5 2 7 1 2 6 0 4 1 9

Tovaglioli



ART	BARCODE	ST.	PREZZO
04 90 73	5906360845570	A	2,25

20 TOVAGLIOLI 3 VELI 33X33CM 019580
'NATALE' PAW

UV1	UV2	IMBALLO
1	12	1/12 PG



5 9 0 6 3 6 0 8 4 5 5 7 0



ART	BARCODE	ST.	PREZZO
04 90 69	5906360526097	A	2,25

20 TOVAGLIOLI 3 VELI 33X33CM 016800
'NATALE' PAW

UV1	UV2	IMBALLO
1	12	1/12 PG



5 9 0 6 3 6 0 5 2 6 0 9 7



ART	BARCODE	ST.	PREZZO
04 90 77	5906360331981	A	2,25

20 TOVAGLIOLI 3 VELI 33X33CM 017800
'NATALE' PAW

UV1	UV2	IMBALLO
1	12	1/12 PG



5 9 0 6 3 6 0 3 3 1 9 8 1



ART	BARCODE	ST.	PREZZO
04 90 57	5906360645460	A	2,25

20 TOVAGLIOLI 3 VELI 33X33CM 013900
'NATALE' PAW

UV1	UV2	IMBALLO
1	12	1/12 PG



5 9 0 6 3 6 0 6 4 5 4 6 0



ART	BARCODE	ST.	PREZZO
04 90 31	5906360468960	A	2,25

20 TOVAGLIOLI 3 VELI 33X33CM 011200
'NATALE' PAW

UV1	UV2	IMBALLO
1	12	1/12 PG



5 9 0 6 3 6 0 4 6 8 9 6 0



ART	BARCODE	ST.	PREZZO
04 90 32	5906360973891	A	2,25

20 TOVAGLIOLI 3 VELI 33X33CM 011200
'NATALE' PAW

UV1	UV2	IMBALLO
1	12	1/12 PG



5 9 0 6 3 6 0 9 7 3 8 9 1



ART	BARCODE	ST.	PREZZO
04 90 33	5906360443943	A	2,25

20 TOVAGLIOLI 3 VELI 33X33CM 011100
'NATALE' PAW

UV1	UV2	IMBALLO
1	12	1/12 PG



5 9 0 6 3 6 0 4 4 3 9 4 3



ART	BARCODE	ST.	PREZZO
04 90 52	5906360500233	A	2,25

20 TOVAGLIOLI 3 VELI 33X33CM 014700
'NATALE' PAW

UV1	UV2	IMBALLO
1	12	1/12 PG



5 9 0 6 3 6 0 5 0 0 2 3 3



ART	BARCODE	ST.	PREZZO
04 90 36	5906360763591	A	2,25

20 TOVAGLIOLI 3 VELI 33X33CM 098500
'NATALE' PAW

UV1	UV2	IMBALLO
1	12	1/12 PG



5 9 0 6 3 6 0 7 6 3 5 9 1



ART	BARCODE	ST.	PREZZO
04 90 51	5906360263022	A	2,25

20 TOVAGLIOLI 3 VELI 33X33CM 016900
'NATALE' PAW

UV1	UV2	IMBALLO
1	12	1/12 PG



5 9 0 6 3 6 0 2 6 3 0 2 2



ART	BARCODE	ST.	PREZZO
04 90 54	5906360035315	A	2,25

20 TOVAGLIOLI 3 VELI 33X33CM 016400
'NATALE' PAW

UV1	UV2	IMBALLO
1	12	1/12 PG



5 9 0 6 3 6 0 0 3 5 3 1 5



ART	BARCODE	ST.	PREZZO
04 90 79	5906360085365	A	2,25

20 TOVAGLIOLI 3 VELI 33X33CM 018800
'NATALE' PAW

UV1	UV2	IMBALLO
1	12	1/12 PG



5 9 0 6 3 6 0 0 8 5 3 6 5



ART	BARCODE	ST.	PREZZO
04 89 98	5906360763409	A	2,25

20 TOVAGLIOLI 3 VELI 33X33 CM 097200 'NATALE' PAW

UV1	UV2	IMBALLO
1	12	1/12 PG



5 9 0 6 3 6 0 7 6 3 4 0 9



ART	BARCODE	ST.	PREZZO
04 90 43	5906360180138	A	2,25

20 TOVAGLIOLI 3 VELI 33X33CM 012309 'NATALE' PAW

UV1	UV2	IMBALLO
1	12	1/12 PG



5 9 0 6 3 6 0 1 8 0 1 3 8



ART	BARCODE	ST.	PREZZO
04 90 56	5906360407891	A	2,25

20 TOVAGLIOLI 3 VELI 33X33CM 012600 'NATALE' PAW

UV1	UV2	IMBALLO
1	12	1/12 PG



5 9 0 6 3 6 0 4 0 7 8 9 1



ART	BARCODE	ST.	PREZZO
04 90 55	5906360392197	A	2,25

20 TOVAGLIOLI 3 VELI 33X33CM 014900 'NATALE' PAW

UV1	UV2	IMBALLO
1	12	1/12 PG



5 9 0 6 3 6 0 3 9 2 1 9 7



ART	BARCODE	ST.	PREZZO
04 90 59	5906360965445	A	2,25

20 TOVAGLIOLI 3 VELI 33X33CM 014500 'NATALE' PAW

UV1	UV2	IMBALLO
1	12	1/12 PG



5 9 0 6 3 6 0 9 6 5 4 4 5



ART	BARCODE	ST.	PREZZO
04 90 10	5906360734973	A	2,25

20 TOVAGLIOLI 3 VELI 33X33CM 080800 'NATALE' PAW

UV1	UV2	IMBALLO
1	12	1/12 PG



5 9 0 6 3 6 0 7 3 4 9 7 3



ART	BARCODE	ST.	PREZZO
04 90 38	5906360763416	A	2,25

20 TOVAGLIOLI 3 VELI 33X33CM 097103 'NATALE' PAW

UV1	UV2	IMBALLO
1	12	1/12 PG



5 9 0 6 3 6 0 7 6 3 4 1 6



ART	BARCODE	ST.	PREZZO
04 90 67	5906360421163	A	2,25

20 TOVAGLIOLI 3 VELI 33X33CM ECO 020300 'NATALE' PAW

UV1	UV2	IMBALLO
1	12	1/12 PG



5 9 0 6 3 6 0 4 2 1 1 6 3



ART	BARCODE	ST.	PREZZO
04 90 64	5906360808902	A	2,25

20 TOVAGLIOLI 3 VELI 33X33CM ECO 018300 'NATALE' PAW

UV1	UV2	IMBALLO
1	12	1/12 PG



5 9 0 6 3 6 0 8 0 8 9 0 2



ART	BARCODE	ST.	PREZZO
04 90 70	5906360480535	A	2,25

20 TOVAGLIOLI 3 VELI 33X33CM 019100 'NATALE' PAW

UV1	UV2	IMBALLO
1	12	1/12 PG



5 9 0 6 3 6 0 4 8 0 5 3 5



ART	BARCODE	ST.	PREZZO
04 90 74	5906360019728	A	2,25

20 TOVAGLIOLI 3 VELI 33X33CM 011400 'NATALE' PAW

UV1	UV2	IMBALLO
1	12	1/12 PG



5 9 0 6 3 6 0 0 1 9 7 2 8



ART	BARCODE	ST.	PREZZO
04 90 68	5906360802832	A	2,25

20 TOVAGLIOLI 3 VELI 33X33CM 018300 'NATALE' PAW

UV1	UV2	IMBALLO
1	12	1/12 PG



5 9 0 6 3 6 0 8 0 2 8 3 2



ART	BARCODE	ST.	PREZZO
04 90 53	5906360512021	A	2,25

20 TOVAGLIOLI 3 VELI 33X33CM 015900
'NATALE' PAW

UV1	UV2	IMBALLO
1	12	1/12 PG



5 9 0 6 3 6 0 5 1 2 0 2 1



ART	BARCODE	ST.	PREZZO
04 90 47	5906360747720	A	2,25

20 TOVAGLIOLI 3 VELI 33X33CM 058909
'NATALE' PAW

UV1	UV2	IMBALLO
1	12	1/12 PG



5 9 0 6 3 6 0 7 4 7 7 2 0



ART	BARCODE	ST.	PREZZO
04 90 61	5906360494419	A	2,25

20 TOVAGLIOLI 3 VELI 33X33CM ECO
016100 'PRIMAVERA' PAW

UV1	UV2	IMBALLO
1	12	1/12 PG



5 9 0 6 3 6 0 4 9 4 4 1 9



ART	BARCODE	ST.	PREZZO
04 90 39	5906360576931	A	2,25

20 TOVAGLIOLI 3 VELI 33X33CM 012303
'NATALE' PAW

UV1	UV2	IMBALLO
1	12	1/12 PG



5 9 0 6 3 6 0 5 7 6 9 3 1



ART	BARCODE	ST.	PREZZO
04 90 34	5906360763553	A	2,25

20 TOVAGLIOLI 3 VELI 33X33CM 098300
'NATALE' PAW

UV1	UV2	IMBALLO
1	12	1/12 PG



5 9 0 6 3 6 0 7 6 3 5 5 3



ART	BARCODE	ST.	PREZZO
04 90 49	5906360763522	A	2,25

20 TOVAGLIOLI 3 VELI 33X33CM 098100
'NATALE' PAW

UV1	UV2	IMBALLO
1	12	1/12 PG



5 9 0 6 3 6 0 7 6 3 5 2 2



ART	BARCODE	ST.	PREZZO
04 90 42	5906360747973	A	2,25

20 TOVAGLIOLI 3 VELI 33X33CM 251003
'NATALE' PAW

UV1	UV2	IMBALLO
1	12	1/12 PG



5 9 0 6 3 6 0 7 4 7 9 7 3



ART	BARCODE	ST.	PREZZO
04 90 58	5906360530605	A	2,25

20 TOVAGLIOLI 3 VELI 33X33CM 012704
'NATALE' PAW

UV1	UV2	IMBALLO
1	12	1/12 PG



5 9 0 6 3 6 0 5 3 0 6 0 5



ART	BARCODE	ST.	PREZZO
04 90 40	5906360005677	A	2,25

20 TOVAGLIOLI 3 VELI 33X33CM 195003
'NATALE' PAW

UV1	UV2	IMBALLO
1	12	1/12 PG



5 9 0 6 3 6 0 0 0 5 6 7 7



ART	BARCODE	ST.	PREZZO
04 90 45	5906360879575	A	2,25

20 TOVAGLIOLI 3 VELI 33X33CM 195009
'NATALE' PAW

UV1	UV2	IMBALLO
1	12	1/12 PG



5 9 0 6 3 6 0 8 7 9 5 7 5



ART	BARCODE	ST.	PREZZO
04 90 48	5906360587418	A	2,25

20 TOVAGLIOLI 3 VELI 33X33CM 012700
'NATALE' PAW

UV1	UV2	IMBALLO
1	12	1/12 PG



5 9 0 6 3 6 0 5 8 7 4 1 8



ART	BARCODE	ST.	PREZZO
04 90 46	5906360763492	A	2,25

20 TOVAGLIOLI 3 VELI 33X33CM 093309
'NATALE' PAW

UV1	UV2	IMBALLO
1	12	1/12 PG



5 9 0 6 3 6 0 7 6 3 4 9 2



ART	BARCODE	ST.	PREZZO
04 90 71	5906360521832	A	2,25

20 TOVAGLIOLI 3 VELI 33X33CM 018900
'NATALE' PAW

UV1	UV2	IMBALLO
1	12	1/12 PG



5 9 0 6 3 6 0 5 2 1 8 3 2



ART	BARCODE	ST.	PREZZO
04 89 99	5906360763577	A	2,25

20 TOVAGLIOLI 3 VELI 33X33 CM 059500
'NATALE' PAW

UV1	UV2	IMBALLO
1	12	1/12 PG



5 9 0 6 3 6 0 7 6 3 5 7 7



ART	BARCODE	ST.	PREZZO
04 89 95	5906360734980	A	2,25

20 TOVAGLIOLI 3 VELI 33X33 CM 080900
'NATALE' PAW

UV1	UV2	IMBALLO
1	12	1/12 PG



5 9 0 6 3 6 0 7 3 4 9 8 0



ART	BARCODE	ST.	PREZZO
04 90 66	5906360333442	A	2,25

20 TOVAGLIOLI 3 VELI 33X33CM ECO
020400 'NATALE' PAW

UV1	UV2	IMBALLO
1	12	1/12 PG



5 9 0 6 3 6 0 3 3 3 4 4 2



ART	BARCODE	ST.	PREZZO
04 90 75	5906360451108	A	2,25

20 TOVAGLIOLI 3 VELI 33X33CM 017300
'NATALE' PAW

UV1	UV2	IMBALLO
1	12	1/12 PG



5 9 0 6 3 6 0 4 5 1 1 0 8



ART	BARCODE	ST.	PREZZO
04 90 76	5906360135152	A	2,25

20 TOVAGLIOLI 3 VELI 33X33CM 017200
'NATALE' PAW

UV1	UV2	IMBALLO
1	12	1/12 PG



5 9 0 6 3 6 0 1 3 5 1 5 2



ART	BARCODE	ST.	PREZZO
04 90 62	5906360180947	A	2,25

20 TOVAGLIOLI 3 VELI 33X33CM ECO
016300 'NATALE' PAW

UV1	UV2	IMBALLO
1	12	1/12 PG



5 9 0 6 3 6 0 1 8 0 9 4 7



ART	BARCODE	ST.	PREZZO
04 90 65	5906360496369	A	2,25

20 TOVAGLIOLI 3 VELI 33X33CM ECO
020200 'NATALE' PAW

UV1	UV2	IMBALLO
1	12	1/12 PG



5 9 0 6 3 6 0 4 9 6 3 6 9



ART	BARCODE	ST.	PREZZO
04 90 78	5906360576313	A	2,25

20 TOVAGLIOLI 3 VELI 33X33CM 019700
'NATALE' PAW

UV1	UV2	IMBALLO
1	12	1/12 PG



5 9 0 6 3 6 0 5 7 6 3 1 3



ART	BARCODE	ST.	PREZZO
04 93 80	5906360056594		2,25

20 TOVAGLIOLI 3 VELI 33X33CM 120610
'PASQUA' PAW

UV1	UV2	IMBALLO
1	12	1/12 PG



5 9 0 6 3 6 0 0 5 6 5 9 4



ART	BARCODE	ST.	PREZZO
04 93 77	5906360395952	A	2,25

20 TOVAGLIOLI 3 VELI 33X33CM 062200
'PASQUA' PAW

UV1	UV2	IMBALLO
1	12	1/12 PG



5 9 0 6 3 6 0 3 9 5 9 5 2



ART	BARCODE	ST.	PREZZO
04 92 86	5906360754926	A	2,25

20 TOVAGLIOLI 3 VELI 33X33CM 095300
'PASQUA' PAW

UV1	UV2	IMBALLO
1	12	1/12 PG



5 9 0 6 3 6 0 7 5 4 9 2 6



ART	BARCODE	ST.	PREZZO
04 92 87*	5906360754933	A	2,25

20 TOVAGLIOLI 3 VELI 33X33CM 095400
'PASQUA' PAW

UV1	UV2	IMBALLO
1	12	1/12 PG



5 9 0 6 3 6 0 7 5 4 9 3 3



ART	BARCODE	ST.	PREZZO
04 93 75*	5906360022773	A	2,25

20 TOVAGLIOLI 3 VELI 33X33CM 055300
'PASQUA' PAW

UV1	UV2	IMBALLO
1	12	1/12 PG



5 9 0 6 3 6 0 0 2 2 7 7 3



ART	BARCODE	ST.	PREZZO
04 93 76*	5906360383256	A	2,25

20 TOVAGLIOLI 3 VELI 33X33CM 054700
'PASQUA' PAW

UV1	UV2	IMBALLO
1	12	1/12 PG



5 9 0 6 3 6 0 3 8 3 2 5 6



ART	BARCODE	ST.	PREZZO
04 93 78*	5906360570267	A	2,25

20 TOVAGLIOLI 3 VELI 33X33CM 060900
'PASQUA' PAW

UV1	UV2	IMBALLO
1	12	1/12 PG



5 9 0 6 3 6 0 5 7 0 2 6 7



ART	BARCODE	ST.	PREZZO
04 92 97*	5906360740738		2,25

20 TOVAGLIOLI 3 VELI 33X33CM 087300
'PASQUA' PAW

UV1	UV2	IMBALLO
1	12	1/12 PG



5 9 0 6 3 6 0 7 4 0 7 3 8



ART	BARCODE	ST.	PREZZO
04 91 93*	5906360096132		2,25

20 TOVAGLIOLI 3 VELI 33X33CM 099100
'PASQUA' PAW

UV1	UV2	IMBALLO
1	12	1/12 PG



5 9 0 6 3 6 0 0 9 6 1 3 2



ART	BARCODE	ST.	PREZZO
04 93 82*	5906360085389	A	2,25

20 TOVAGLIOLI 3 VELI 33X33CM 120611
'PASQUA' PAW

UV1	UV2	IMBALLO
1	12	1/12 PG



5 9 0 6 3 6 0 0 8 5 3 8 9



ART	BARCODE	ST.	PREZZO
04 91 91*	5906360426014	A	2,25

20 TOVAGLIOLI 3 VELI 33X33CM 122000
'PASQUA' PAW

UV1	UV2	IMBALLO
1	12	1/12 PG



5 9 0 6 3 6 0 4 2 6 0 1 4



ART	BARCODE	ST.	PREZZO
04 91 92*	5906360653038		2,25

20 TOVAGLIOLI 3 VELI 33X33CM 121600
'PASQUA' PAW

UV1	UV2	IMBALLO
1	12	1/12 PG



5 9 0 6 3 6 0 6 5 3 0 3 8



ART	BARCODE	ST.	PREZZO
04 93 81*	5906360754940	A	2,25

20 TOVAGLIOLI 3 VELI 33X33CM 095500
'PASQUA' PAW

UV1	UV2	IMBALLO
1	12	1/12 PG



5 9 0 6 3 6 0 7 5 4 9 4 0



ART	BARCODE	ST.	PREZZO
04 91 95*	5906360859355		2,25

20 TOVAGLIOLI 3 VELI 33X33CM 120617
'PASQUA' PAW

UV1	UV2	IMBALLO
1	12	1/12 PG



5 9 0 6 3 6 0 8 5 9 3 5 5



ART	BARCODE	ST.	PREZZO
04 91 96*	5906360898576		2,25

20 TOVAGLIOLI 3 VELI 33X33CM 120603
'PASQUA' PAW

UV1	UV2	IMBALLO
1	12	1/12 PG



5 9 0 6 3 6 0 8 9 8 5 7 6



ART	BARCODE	ST.	PREZZO
04 91 97	5906360708776		2,25

20 TOVAGLIOLI 3 VELI 33X33CM 061400
'PASQUA' PAW

UV1	UV2	IMBALLO
1	12	1/12 PG



5 9 0 6 3 6 0 7 0 8 7 7 6



ART	BARCODE	ST.	PREZZO
04 91 98	5906360627596		2,25

20 TOVAGLIOLI 3 VELI 33X33CM 128300
'PASQUA' PAW

UV1	UV2	IMBALLO
1	12	1/12 PG



5 9 0 6 3 6 0 6 2 7 5 9 6



ART	BARCODE	ST.	PREZZO
04 97 01	5906360223231		2,00

20 TOVAGLIOLI 3 VELI 33X33CM 705000
'PASQUA' TETE A TETE

UV1	UV2	IMBALLO
1	12	1/12 PG



5 9 0 6 3 6 0 2 2 3 2 3 1



ART	BARCODE	ST.	PREZZO
04 97 02	5906360540307		2,00

20 TOVAGLIOLI 3 VELI 33X33CM 704900
'PASQUA' TETE A TETE

UV1	UV2	IMBALLO
1	12	1/12 PG



5 9 0 6 3 6 0 5 4 0 3 0 7



ART	BARCODE	ST.	PREZZO
04 97 03	5906360635201		2,00

20 TOVAGLIOLI 3 VELI 33X33CM 700200
'PASQUA' TETE A TETE

UV1	UV2	IMBALLO
1	12	1/12 PG



5 9 0 6 3 6 0 6 3 5 2 0 1



ART	BARCODE	ST.	PREZZO
04 97 04	5906360322132		2,00

20 TOVAGLIOLI 3 VELI 33X33CM 703300
'PASQUA' TETE A TETE

UV1	UV2	IMBALLO
1	12	1/12 PG



5 9 0 6 3 6 0 3 2 2 1 3 2



ART	BARCODE	ST.	PREZZO
04 97 05	5906360934069		2,00

20 TOVAGLIOLI 3 VELI 33X33CM 703900
'PASQUA' TETE A TETE

UV1	UV2	IMBALLO
1	12	1/12 PG



5 9 0 6 3 6 0 9 3 4 0 6 9



ART	BARCODE	ST.	PREZZO
04 97 06	5906360236385		2,00

20 TOVAGLIOLI 3 VELI 33X33CM 703500
'PASQUA' TETE A TETE

UV1	UV2	IMBALLO
1	12	1/12 PG



5 9 0 6 3 6 0 2 3 6 3 8 5



ART	BARCODE	ST.	PREZZO
04 97 07	5906360760323		2,00

20 TOVAGLIOLI 3 VELI 33X33CM 665000
'PASQUA' TETE A TETE

UV1	UV2	IMBALLO
1	12	1/12 PG



5 9 0 6 3 6 0 7 6 0 3 2 3



ART	BARCODE	ST.	PREZZO
04 97 08	5906360345278		2,00

20 TOVAGLIOLI 3 VELI 33X33CM 702000
'PASQUA' TETE A TETE

UV1	UV2	IMBALLO
1	12	1/12 PG



5 9 0 6 3 6 0 3 4 5 2 7 8



ART	BARCODE	ST.	PREZZO
04 97 09	5906360760347		2,00

20 TOVAGLIOLI 3 VELI 33X33CM 667000
'PASQUA' TETE A TETE

UV1	UV2	IMBALLO
1	12	1/12 PG



5 9 0 6 3 6 0 7 6 0 3 4 7



ART	BARCODE	ST.	PREZZO
04 93 24	5906360751185	A	2,25

20 TOVAGLIOLI 3 VELI 33X33CM 090300
'PRIMAVERA' PAW

UV1	UV2	IMBALLO
1	12	1/12 PG



5 9 0 6 3 6 0 7 5 1 1 8 5



ART	BARCODE	ST.	PREZZO
04 93 86	5906360668636		2,25
20 TOVAGLIOLI 3 VELI 33X33CM 120108 'PRIMAVERA' PAW			
UV1	UV2	IMBALLO	
1	12	1/12 PG	



5 9 0 6 3 6 0 6 6 8 6 3 6



ART	BARCODE	ST.	PREZZO
04 93 60	5906360796766	A	2,25
20 TOVAGLIOLI 3 VELI 33X33CM 054500 'PRIMAVERA' PAW			
UV1	UV2	IMBALLO	
1	12	1/12 PG	



5 9 0 6 3 6 0 7 9 6 7 6 6



ART	BARCODE	ST.	PREZZO
04 93 88	5906360015171		2,25
20 TOVAGLIOLI 3 VELI 33X33CM 120107 'PRIMAVERA' PAW			
UV1	UV2	IMBALLO	
1	12	1/12 PG	



5 9 0 6 3 6 0 0 1 5 1 7 1



ART	BARCODE	ST.	PREZZO
04 91 79	5906360643299		2,25
20 TOVAGLIOLI 3 VELI 33X33CM 122600 'PRIMAVERA' PAW			
UV1	UV2	IMBALLO	
1	12	1/12 PG	



5 9 0 6 3 6 0 6 4 3 2 9 9



ART	BARCODE	ST.	PREZZO
04 93 35	5906360751253	A	2,25
20 TOVAGLIOLI 3 VELI 33X33CM 091100 'PRIMAVERA' PAW			
UV1	UV2	IMBALLO	
1	12	1/12 PG	



5 9 0 6 3 6 0 7 5 1 2 5 3



ART	BARCODE	ST.	PREZZO
04 93 62	5906360406955	A	2,25
20 TOVAGLIOLI 3 VELI 33X33CM 054800 'PRIMAVERA' PAW			
UV1	UV2	IMBALLO	
1	12	1/12 PG	



5 9 0 6 3 6 0 4 0 6 9 5 5



ART	BARCODE	ST.	PREZZO
04 92 76	5906360728507	A	2,25
20 TOVAGLIOLI 3 VELI 33X33CM 000400 'PRIMAVERA' PAW			
UV1	UV2	IMBALLO	
1	12	1/12 PG	



5 9 0 6 3 6 0 7 2 8 5 0 7



ART	BARCODE	ST.	PREZZO
04 91 71	5906360514735		2,25
20 TOVAGLIOLI 3 VELI 33X33CM 121800 'PRIMAVERA' PAW			
UV1	UV2	IMBALLO	
1	12	1/12 PG	



5 9 0 6 3 6 0 5 1 4 7 3 5



ART	BARCODE	ST.	PREZZO
04 93 67	5906360015775	A	2,25
20 TOVAGLIOLI 3 VELI 33X33CM 055200 'PRIMAVERA' PAW			
UV1	UV2	IMBALLO	
1	12	1/12 PG	



5 9 0 6 3 6 0 0 1 5 7 7 5



ART	BARCODE	ST.	PREZZO
04 93 85	5906360537772	A	2,25
20 TOVAGLIOLI 3 VELI 33X33CM 120110 'PRIMAVERA' PAW			
UV1	UV2	IMBALLO	
1	12	1/12 PG	



5 9 0 6 3 6 0 5 3 7 7 7 2



ART	BARCODE	ST.	PREZZO
04 93 70	5906360740462	A	2,25
20 TOVAGLIOLI 3 VELI 33X33CM 086800 'PRIMAVERA' PAW			
UV1	UV2	IMBALLO	
1	12	1/12 PG	



5 9 0 6 3 6 0 7 4 0 4 6 2



ART	BARCODE	ST.	PREZZO
04 93 87	5906360415940	A	2,25
20 TOVAGLIOLI 3 VELI 33X33CM 120101 'PRIMAVERA' PAW			
UV1	UV2	IMBALLO	
1	12	1/12 PG	



5 9 0 6 3 6 0 4 1 5 9 4 0



ART	BARCODE	ST.	PREZZO
04 91 70	5906360910674	A	2,25

20 TOVAGLIOLI 3 VELI 33X33CM 121500
'PRIMAVERA' PAW

UV1	UV2	IMBALLO
1	12	1/12 PG



5 9 0 6 3 6 0 9 1 0 6 7 4



ART	BARCODE	ST.	PREZZO
04 92 10	5906360996593	A	2,25

20 TOVAGLIOLI 3 VELI 33X33CM 290000
'PRIMAVERA' PAW

UV1	UV2	IMBALLO
1	12	1/12 PG



5 9 0 6 3 6 0 9 9 6 5 9 3



ART	BARCODE	ST.	PREZZO
04 91 82	5906360378078	A	2,25

20 TOVAGLIOLI 3 VELI 33X33CM 123800
'PRIMAVERA' PAW

UV1	UV2	IMBALLO
1	12	1/12 PG



5 9 0 6 3 6 0 3 7 8 0 7 8



ART	BARCODE	ST.	PREZZO
04 93 61	5906360084160	A	2,25

20 TOVAGLIOLI 3 VELI 33X33CM 061800
'PRIMAVERA' PAW

UV1	UV2	IMBALLO
1	12	1/12 PG



5 9 0 6 3 6 0 0 8 4 1 6 0



ART	BARCODE	ST.	PREZZO
04 93 65	5906360014747	A	2,25

20 TOVAGLIOLI 3 VELI 33X33CM 061600
'PRIMAVERA' PAW

UV1	UV2	IMBALLO
1	12	1/12 PG



5 9 0 6 3 6 0 0 1 4 7 4 7



ART	BARCODE	ST.	PREZZO
04 93 41	5906360751192	A	2,25

20 TOVAGLIOLI 3 VELI 33X33CM 090400
'PRIMAVERA' PAW

UV1	UV2	IMBALLO
1	12	1/12 PG



5 9 0 6 3 6 0 7 5 1 1 9 2



ART	BARCODE	ST.	PREZZO
04 91 77	5906360751161	A	2,25

20 TOVAGLIOLI 3 VELI 33X33CM 090100
'PRIMAVERA' PAW

UV1	UV2	IMBALLO
1	12	1/12 PG



5 9 0 6 3 6 0 7 5 1 1 6 1



ART	BARCODE	ST.	PREZZO
04 93 30	5906360751178	A	2,25

20 TOVAGLIOLI 3 VELI 33X33CM 090200
'PRIMAVERA' PAW

UV1	UV2	IMBALLO
1	12	1/12 PG



5 9 0 6 3 6 0 7 5 1 1 7 8



ART	BARCODE	ST.	PREZZO
04 91 72	5906360739725	A	2,25

20 TOVAGLIOLI 3 VELI 33X33CM 084300
'PRIMAVERA' PAW

UV1	UV2	IMBALLO
1	12	1/12 PG



5 9 0 6 3 6 0 7 3 9 7 2 5



ART	BARCODE	ST.	PREZZO
04 93 51	5906360742077	A	2,25

20 TOVAGLIOLI 3 VELI 33X33CM 973000
'PRIMAVERA' PAW

UV1	UV2	IMBALLO
1	12	1/12 PG



5 9 0 6 3 6 0 7 4 2 0 7 7



ART	BARCODE	ST.	PREZZO
04 93 68	5906360818093	A	2,25

20 TOVAGLIOLI 3 VELI 33X33CM 055400
'PRIMAVERA' PAW

UV1	UV2	IMBALLO
1	12	1/12 PG



5 9 0 6 3 6 0 8 1 8 0 9 3



ART	BARCODE	ST.	PREZZO
04 93 90	5906360383669	A	2,25

20 TOVAGLIOLI 3 VELI 33X33CM 120102
'PRIMAVERA' PAW

UV1	UV2	IMBALLO
1	12	1/12 PG



5 9 0 6 3 6 0 3 8 3 6 6 9



ART	BARCODE	ST.	PREZZO
04 93 91	5906360332858	A	2,25

20 TOVAGLIOLI 3 VELI 33X33CM 120103
'PRIMAVERA' PAW

UV1	UV2	IMBALLO
1	12	1/12 PG



5 9 0 6 3 6 0 3 3 2 8 5 8



ART	BARCODE	ST.	PREZZO
04 93 69	5906360364026	A	2,25

20 TOVAGLIOLI 3 VELI 33X33CM 060600
'PRIMAVERA' PAW

UV1	UV2	IMBALLO
1	12	1/12 PG



5 9 0 6 3 6 0 3 6 4 0 2 6



ART	BARCODE	ST.	PREZZO
04 91 73	5906360713015	A	2,25

20 TOVAGLIOLI 3 VELI 33X33CM 091201
'PRIMAVERA' PAW

UV1	UV2	IMBALLO
1	12	1/12 PG



5 9 0 6 3 6 0 7 1 3 0 1 5



ART	BARCODE	ST.	PREZZO
04 93 92	5906360282764	A	2,25

20 TOVAGLIOLI 3 VELI 33X33CM 061324
'PRIMAVERA' PAW

UV1	UV2	IMBALLO
1	12	1/12 PG



5 9 0 6 3 6 0 2 8 2 7 6 4



ART	BARCODE	ST.	PREZZO
04 91 74	5906360281866	A	2,25

20 TOVAGLIOLI 3 VELI 33X33CM 055600
'PRIMAVERA' PAW

UV1	UV2	IMBALLO
1	12	1/12 PG



5 9 0 6 3 6 0 2 8 1 8 6 6



ART	BARCODE	ST.	PREZZO
04 91 76	5906360428285	A	2,25

20 TOVAGLIOLI 3 VELI 33X33CM 120114
'PRIMAVERA' PAW

UV1	UV2	IMBALLO
1	12	1/12 PG



5 9 0 6 3 6 0 4 2 8 2 8 5



ART	BARCODE	ST.	PREZZO
04 91 81	5906360874662		2,25

20 TOVAGLIOLI 3 VELI 33X33CM 122100
'PRIMAVERA' PAW

UV1	UV2	IMBALLO
1	12	1/12 PG



5 9 0 6 3 6 0 8 7 4 6 6 2



ART	BARCODE	ST.	PREZZO
04 91 83	5906360387421	A	2,25

20 TOVAGLIOLI 3 VELI 33X33CM 123900
'PRIMAVERA' PAW

UV1	UV2	IMBALLO
1	12	1/12 PG



5 9 0 6 3 6 0 3 8 7 4 2 1



ART	BARCODE	ST.	PREZZO
04 91 78	5906360252965	A	2,25

20 TOVAGLIOLI 3 VELI 33X33CM 122900
'PRIMAVERA' PAW

UV1	UV2	IMBALLO
1	12	1/12 PG



5 9 0 6 3 6 0 2 5 2 9 6 5

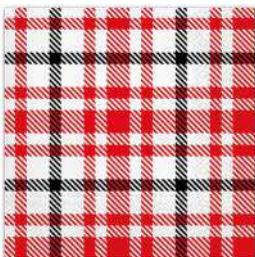

ART	BARCODE	ST.	PREZZO
04 93 93	5906360755053	A	2,25

20 TOVAGLIOLI 3 VELI 33X33CM 096700
'PRIMAVERA' PAW

UV1	UV2	IMBALLO
1	12	1/12 PG



5 9 0 6 3 6 0 7 5 5 0 5 3



ART	BARCODE	ST.	PREZZO
04 91 49	5906360490732		2,25

20 TOVAGLIOLI 3 VELI 33X33CM ECO
120113 'PRIMAVERA' PAW

UV1	UV2	IMBALLO
1	12	1/12 PG



5 9 0 6 3 6 0 4 9 0 7 3 2



ART	BARCODE	ST.	PREZZO
04 91 50	5906360581652		2,25

20 TOVAGLIOLI 3 VELI 33X33CM 097705
'PRIMAVERA' PAW

UV1	UV2	IMBALLO
1	12	1/12 PG



5 9 0 6 3 6 0 5 8 1 6 5 2



ART	BARCODE	ST.	PREZZO
04 92 24	5906360717693		2,25

20 TOVAGLIOLI 3 VELI 33X33CM 859000
'PRIMAVERA' PAW

UV1	UV2	IMBALLO
1	12	1/12 PG



5 9 0 6 3 6 0 7 1 7 6 9 3



ART	BARCODE	ST.	PREZZO
04 91 46	5906360367027		2,25

20 TOVAGLIOLI 3 VELI 33X33CM ECO
031300 'PRIMAVERA' PAW

UV1	UV2	IMBALLO
1	12	1/12 PG



5 9 0 6 3 6 0 3 6 7 0 2 7



ART	BARCODE	ST.	PREZZO
04 91 47	5906360312867		2,25

20 TOVAGLIOLI 3 VELI 33X33CM ECO
030200 'PRIMAVERA' PAW

UV1	UV2	IMBALLO
1	12	1/12 PG



5 9 0 6 3 6 0 3 1 2 8 6 7



ART	BARCODE	ST.	PREZZO
04 91 48	5906360696721		2,25

20 TOVAGLIOLI 3 VELI 33X33CM ECO
085500 'PRIMAVERA' PAW

UV1	UV2	IMBALLO
1	12	1/12 PG



5 9 0 6 3 6 0 6 9 6 7 2 1



ART	BARCODE	ST.	PREZZO
04 91 51	5906360903737		2,25

20 TOVAGLIOLI 3 VELI 33X33CM 126900
'PRIMAVERA' PAW

UV1	UV2	IMBALLO
1	12	1/12 PG



5 9 0 6 3 6 0 9 0 3 7 3 7



ART	BARCODE	ST.	PREZZO
04 91 52	5906360295177		2,25

20 TOVAGLIOLI 3 VELI 33X33CM 126805
'PRIMAVERA' PAW

UV1	UV2	IMBALLO
1	12	1/12 PG



5 9 0 6 3 6 0 2 9 5 1 7 7



ART	BARCODE	ST.	PREZZO
04 91 53	5906360368505		2,25

20 TOVAGLIOLI 3 VELI 33X33CM 126700
'PRIMAVERA' PAW

UV1	UV2	IMBALLO
1	12	1/12 PG



5 9 0 6 3 6 0 3 6 8 5 0 5



ART	BARCODE	ST.	PREZZO
04 91 54	5906360778151		2,25

20 TOVAGLIOLI 3 VELI 33X33CM 120104
'PRIMAVERA' PAW

UV1	UV2	IMBALLO
1	12	1/12 PG



5 9 0 6 3 6 0 7 7 8 1 5 1



ART	BARCODE	ST.	PREZZO
04 91 55	5906360219173		2,25

20 TOVAGLIOLI 3 VELI 33X33CM 130800
'PRIMAVERA' PAW

UV1	UV2	IMBALLO
1	12	1/12 PG



5 9 0 6 3 6 0 2 1 9 1 7 3



ART	BARCODE	ST.	PREZZO
04 91 56	5906360670516		2,25

20 TOVAGLIOLI 3 VELI 33X33CM 130900
'PRIMAVERA' PAW

UV1	UV2	IMBALLO
1	12	1/12 PG



5 9 0 6 3 6 0 6 7 0 5 1 6



ART	BARCODE	ST.	PREZZO
04 91 57	5906360343410		2,25

20 TOVAGLIOLI 3 VELI 33X33CM 129300
'PRIMAVERA' PAW

UV1	UV2	IMBALLO
1	12	1/12 PG



5 9 0 6 3 6 0 3 4 3 4 1 0



ART	BARCODE	ST.	PREZZO
04 91 58	5906360565348		2,25

20 TOVAGLIOLI 3 VELI 33X33CM 129200
'PRIMAVERA' PAW

UV1	UV2	IMBALLO
1	12	1/12 PG



5 9 0 6 3 6 0 5 6 5 3 4 8



ART	BARCODE	ST.	PREZZO
04 91 59	5906360582024		2,25

20 TOVAGLIOLI 3 VELI 33X33CM 131000
'PRIMAVERA' PAW

UV1	UV2	IMBALLO
1	12	1/12 PG



5 9 0 6 3 6 0 5 8 2 0 2 4



ART	BARCODE	ST.	PREZZO
04 91 61	5906360743142		2,25

20 TOVAGLIOLI 3 VELI 33X33CM 031200
'PRIMAVERA' PAW

UV1	UV2	IMBALLO
1	12	1/12 PG



5 9 0 6 3 6 0 7 4 3 1 4 2



ART	BARCODE	ST.	PREZZO
04 91 62	5906360829174		2,25

20 TOVAGLIOLI 3 VELI 33X33CM 128800
'PRIMAVERA' PAW

UV1	UV2	IMBALLO
1	12	1/12 PG



5 9 0 6 3 6 0 8 2 9 1 7 4



ART	BARCODE	ST.	PREZZO
04 91 63	5906360643343		2,25

20 TOVAGLIOLI 3 VELI 33X33CM 121700
'PRIMAVERA' PAW

UV1	UV2	IMBALLO
1	12	1/12 PG



5 9 0 6 3 6 0 6 4 3 3 4 3



ART	BARCODE	ST.	PREZZO
04 91 64	5906360458312		2,25

20 TOVAGLIOLI 3 VELI 33X33CM 126500
'PRIMAVERA' PAW

UV1	UV2	IMBALLO
1	12	1/12 PG



5 9 0 6 3 6 0 4 5 8 3 1 2



ART	BARCODE	ST.	PREZZO
04 91 65	5906360460094		2,25

20 TOVAGLIOLI 3 VELI 33X33CM 126600
'PRIMAVERA' PAW

UV1	UV2	IMBALLO
1	12	1/12 PG



5 9 0 6 3 6 0 4 6 0 0 9 4



ART	BARCODE	ST.	PREZZO
04 97 43	5906360367645		2,00

20 TOVAGLIOLI 3 VELI 33X33CM 700800
'PRIMAVERA' TETE A TETE

UV1	UV2	IMBALLO
1	12	1/12 PG



5 9 0 6 3 6 0 3 6 7 6 4 5



ART	BARCODE	ST.	PREZZO
04 91 66	5906360683158		2,25

20 TOVAGLIOLI 3 VELI 33X33CM 127611
'PRIMAVERA' PAW

UV1	UV2	IMBALLO
1	12	1/12 PG



5 9 0 6 3 6 0 6 8 3 1 5 8



ART	BARCODE	ST.	PREZZO
04 91 67	5906360616477		2,25

20 TOVAGLIOLI 3 VELI 33X33CM 129100
'PRIMAVERA' PAW

UV1	UV2	IMBALLO
1	12	1/12 PG



5 9 0 6 3 6 0 6 1 6 4 7 7



ART	BARCODE	ST.	PREZZO
04 91 68	5906360753370		2,25

20 TOVAGLIOLI 3 VELI 33X33CM 092800
'PRIMAVERA' PAW

UV1	UV2	IMBALLO
1	12	1/12 PG



5 9 0 6 3 6 0 7 5 3 3 7 0



ART	BARCODE	ST.	PREZZO
04 97 41	5906360180879		2,00

20 TOVAGLIOLI 3 VELI 33X33CM 705100
'PRIMAVERA' TETE A TETE

UV1	UV2	IMBALLO
1	12	1/12 PG



5 9 0 6 3 6 0 1 8 0 8 7 9



ART	BARCODE	ST.	PREZZO
04 97 44	5906360589436		2,00

20 TOVAGLIOLI 3 VELI 33X33CM 700900
'PRIMAVERA' TETE A TETE

UV1	UV2	IMBALLO
1	12	1/12 PG



5 9 0 6 3 6 0 5 8 9 4 3 6



ART	BARCODE	ST.	PREZZO
04 97 42	5906360986266		2,00

20 TOVAGLIOLI 3 VELI 33X33CM 315000
'PRIMAVERA' TETE A TETE

UV1	UV2	IMBALLO
1	12	1/12 PG



5 9 0 6 3 6 0 9 8 6 2 6 6



ART	BARCODE	ST.	PREZZO
04 97 45	5906360743562		2,00

20 TOVAGLIOLI 3 VELI 33X33CM 567000
'PRIMAVERA' TETE A TETE

UV1	UV2	IMBALLO
1	12	1/12 PG



5 9 0 6 3 6 0 7 4 3 5 6 2



ART	BARCODE	ST.	PREZZO
04 97 46	5906360743555		2,00

20 TOVAGLIOLI 3 VELI 33X33CM 566000
'PRIMAVERA' TETE A TETE

UV1	UV2	IMBALLO
1	12	1/12 PG



5 9 0 6 3 6 0 7 4 3 5 5 5



ART	BARCODE	ST.	PREZZO
04 97 47	5906360841244		2,00

20 TOVAGLIOLI 3 VELI 33X33CM 701500
'PRIMAVERA' TETE A TETE

UV1	UV2	IMBALLO
1	12	1/12 PG



5 9 0 6 3 6 0 8 4 1 2 4 4



ART	BARCODE	ST.	PREZZO
04 97 48	5906360026405		2,00

20 TOVAGLIOLI 3 VELI 33X33CM 701200
'PRIMAVERA' TETE A TETE

UV1	UV2	IMBALLO
1	12	1/12 PG



5 9 0 6 3 6 0 0 2 6 4 0 5



ART	BARCODE	ST.	PREZZO
04 97 49	5906360008333		2,00

20 TOVAGLIOLI 3 VELI 33X33CM 694004
'PRIMAVERA' TETE A TETE

UV1	UV2	IMBALLO
1	12	1/12 PG



5 9 0 6 3 6 0 0 0 8 3 3 3



ART	BARCODE	ST.	PREZZO
04 97 50	5906360135435		2,00

20 TOVAGLIOLI 3 VELI 33X33CM 703700
'PRIMAVERA' TETE A TETE

UV1	UV2	IMBALLO
1	12	1/12 PG



5 9 0 6 3 6 0 1 3 5 4 3 5



ART	BARCODE	ST.	PREZZO
04 97 51	5906360885255		2,00

20 TOVAGLIOLI 3 VELI 33X33CM 701800
'PRIMAVERA' TETE A TETE

UV1	UV2	IMBALLO
1	12	1/12 PG



5 9 0 6 3 6 0 8 8 5 2 5 5



ART	BARCODE	ST.	PREZZO
04 97 52	5906360666717		2,00

20 TOVAGLIOLI 3 VELI 33X33CM 704100
'PRIMAVERA' TETE A TETE

UV1	UV2	IMBALLO
1	12	1/12 PG



5 9 0 6 3 6 0 6 6 6 7 1 7



ART	BARCODE	ST.	PREZZO
04 97 53	5906360500196		2,00

20 TOVAGLIOLI 3 VELI 33X33CM 704400
'PRIMAVERA' TETE A TETE

UV1	UV2	IMBALLO
1	12	1/12 PG



5 9 0 6 3 6 0 5 0 0 1 9 6



ART	BARCODE	ST.	PREZZO
04 97 54	5906360411270		2,00

20 TOVAGLIOLI 3 VELI 33X33CM 702109
'PRIMAVERA' TETE A TETE

UV1	UV2	IMBALLO
1	12	1/12 PG



5 9 0 6 3 6 0 4 1 1 2 7 0



ART	BARCODE	ST.	PREZZO
04 97 55	5906360456691		2,00

20 TOVAGLIOLI 3 VELI 33X33CM 702102
'PRIMAVERA' TETE A TETE

UV1	UV2	IMBALLO
1	12	1/12 PG



5 9 0 6 3 6 0 4 5 6 6 9 1



ART	BARCODE	ST.	PREZZO
04 97 56	5906360169638		2,00

20 TOVAGLIOLI 3 VELI 33X33CM 700500
'PRIMAVERA' TETE A TETE

UV1	UV2	IMBALLO
1	12	1/12 PG



5 9 0 6 3 6 0 1 6 9 6 3 8



ART	BARCODE	ST.	PREZZO
04 97 57	5906360137163		2,00

20 TOVAGLIOLI 3 VELI 33X33CM 318009
'PRIMAVERA' TETE A TETE

UV1	UV2	IMBALLO
1	12	1/12 PG



5 9 0 6 3 6 0 1 3 7 1 6 3



ART	BARCODE	ST.	PREZZO
04 91 80	5906360575828		2,25

20 TOVAGLIOLI 3 VELI 33X33CM 055700
'AUTUNNO' PAW

UV1	UV2	IMBALLO
1	12	1/12 PG



5 9 0 6 3 6 0 5 7 5 8 2 8



ART	BARCODE	ST.	PREZZO
04 88 55	5906360740929	A	2,25

20 TOVAGLIOLI 3 VELI 33X33CM 087900
'AUTUNNO' PAW

UV1	UV2	IMBALLO
1	12	1/12 PG



5 9 0 6 3 6 0 7 4 0 9 2 9



ART	BARCODE	ST.	PREZZO
04 88 52	5906360958386	A	2,25

20 TOVAGLIOLI 3 VELI 33X33CM 062600
'AUTUNNO' PAW

UV1	UV2	IMBALLO
1	12	1/12 PG



5 9 0 6 3 6 0 9 5 8 3 8 6



ART	BARCODE	ST.	PREZZO
04 88 15	5906360742756	A	2,25

20 TOVAGLIOLI 3 VELI 33X33CM 089600
'AUTUNNO' PAW

UV1	UV2	IMBALLO
1	12	1/12 PG



5 9 0 6 3 6 0 7 4 2 7 5 6



ART	BARCODE	ST.	PREZZO
04 88 73	5906360717402	A	2,25

20 TOVAGLIOLI 3 VELI 33X33CM 839000
'AUTUNNO' PAW

UV1	UV2	IMBALLO
1	12	1/12 PG



5 9 0 6 3 6 0 7 1 7 4 0 2



ART	BARCODE	ST.	PREZZO
04 88 45	5906360413915	A	2,25

20 TOVAGLIOLI 3 VELI 33X33CM 120100
'AUTUNNO' PAW

UV1	UV2	IMBALLO
1	12	1/12 PG



5 9 0 6 3 6 0 4 1 3 9 1 5



ART	BARCODE	ST.	PREZZO
04 88 51	5906360706765		2,25

20 TOVAGLIOLI 3 VELI 33X33CM 055800
'AUTUNNO' PAW

UV1	UV2	IMBALLO
1	12	1/12 PG



5 9 0 6 3 6 0 7 0 6 7 6 5



ART	BARCODE	ST.	PREZZO
04 88 40	5906360060676		2,25

20 TOVAGLIOLI 3 VELI 33X33CM 123300
'AUTUNNO' PAW

UV1	UV2	IMBALLO
1	12	1/12 PG



5 9 0 6 3 6 0 0 6 0 6 7 6



ART	BARCODE	ST.	PREZZO
04 88 41	5906360689365	A	2,25

20 TOVAGLIOLI 3 VELI 33X33CM 125000
'AUTUNNO' PAW

UV1	UV2	IMBALLO
1	12	1/12 PG



5 9 0 6 3 6 0 6 8 9 3 6 5



ART	BARCODE	ST.	PREZZO
04 88 42	5906360553697	A	2,25

20 TOVAGLIOLI 3 VELI 33X33CM 123400
'AUTUNNO' PAW

UV1	UV2	IMBALLO
1	12	1/12 PG



5 9 0 6 3 6 0 5 5 3 6 9 7



ART	BARCODE	ST.	PREZZO
04 88 44	5906360674248	A	2,25

20 TOVAGLIOLI 3 VELI 33X33CM 062400
'AUTUNNO' PAW

UV1	UV2	IMBALLO
1	12	1/12 PG



5 9 0 6 3 6 0 6 7 4 2 4 8



ART	BARCODE	ST.	PREZZO
04 88 46	5906360514308	A	2,25

20 TOVAGLIOLI 3 VELI 33X33CM 060300
'AUTUNNO' PAW

UV1	UV2	IMBALLO
1	12	1/12 PG



5 9 0 6 3 6 0 5 1 4 3 0 8



ART	BARCODE	ST.	PREZZO
04 88 35	5906360232165		2,25

20 TOVAGLIOLI 3 VELI 33X33CM 126802
'AUTUNNO' PAW

UV1	UV2	IMBALLO
1	12	1/12 PG



5 9 0 6 3 6 0 2 3 2 1 6 5



ART	BARCODE	ST.	PREZZO
04 88 36	5906360220070		2,25

20 TOVAGLIOLI 3 VELI 33X33CM 126000
'AUTUNNO' PAW

UV1	UV2	IMBALLO
1	12	1/12 PG



5 9 0 6 3 6 0 2 2 0 0 7 0



ART	BARCODE	ST.	PREZZO
04 88 37	5906360694437		2,25

20 TOVAGLIOLI 3 VELI 33X33CM 127500
'AUTUNNO' PAW

UV1	UV2	IMBALLO
1	12	1/12 PG



5 9 0 6 3 6 0 6 9 4 4 3 7



ART	BARCODE	ST.	PREZZO
04 88 38	5906360584844		2,25

20 TOVAGLIOLI 3 VELI 33X33CM 127200
'AUTUNNO' PAW

UV1	UV2	IMBALLO
1	12	1/12 PG



5 9 0 6 3 6 0 5 8 4 8 4 4



ART	BARCODE	ST.	PREZZO
04 88 39	5906360189711		2,25

20 TOVAGLIOLI 3 VELI 33X33CM 127300
'AUTUNNO' PAW

UV1	UV2	IMBALLO
1	12	1/12 PG



5 9 0 6 3 6 0 1 8 9 7 1 1



ART	BARCODE	ST.	PREZZO
04 88 47	5906360790177		2,25

20 TOVAGLIOLI 3 VELI 33X33CM 127102
'AUTUNNO' PAW

UV1	UV2	IMBALLO
1	12	1/12 PG



5 9 0 6 3 6 0 7 9 0 1 7 7



ART	BARCODE	ST.	PREZZO
04 88 48	5906360066258		2,25

20 TOVAGLIOLI 3 VELI 33X33CM 302118
'AUTUNNO' PAW

UV1	UV2	IMBALLO
1	12	1/12 PG



5 9 0 6 3 6 0 0 6 6 2 5 8



ART	BARCODE	ST.	PREZZO
04 88 49	5906360921618		2,25

20 TOVAGLIOLI 3 VELI 33X33CM 127000
'AUTUNNO' PAW

UV1	UV2	IMBALLO
1	12	1/12 PG



5 9 0 6 3 6 0 9 2 1 6 1 8



ART	BARCODE	ST.	PREZZO
04 88 50	5906360640212		2,25

20 TOVAGLIOLI 3 VELI 33X33CM 127124
'AUTUNNO' PAW

UV1	UV2	IMBALLO
1	12	1/12 PG



5 9 0 6 3 6 0 6 4 0 2 1 2



ART	BARCODE	ST.	PREZZO
04 93 44	5906360637526	A	2,25

20 TOVAGLIOLI 3 VELI 33X33CM 120106
'LOVE' PAW

UV1	UV2	IMBALLO
1	12	1/12 PG



5 9 0 6 3 6 0 6 3 7 5 2 6



ART	BARCODE	ST.	PREZZO
04 93 45	5906360150766	A	2,25
20 TOVAGLIOLI 3 VELI 33X33CM 093809 'LOVE' PAW			
UV1	UV2	IMBALLO	
1	12	1/12 PG	



5 9 0 6 3 6 0 1 5 0 7 6 6



ART	BARCODE	ST.	PREZZO
04 93 57	5906360740875		2,25
20 TOVAGLIOLI 3 VELI 33X33CM 087500 'KITCHEN' PAW			
UV1	UV2	IMBALLO	
1	12	1/12 PG	



5 9 0 6 3 6 0 7 4 0 8 7 5



ART	BARCODE	ST.	PREZZO
04 92 08	5906360719741		2,25
20 TOVAGLIOLI 3 VELI 33X33CM 874000 'KITCHEN' PAW			
UV1	UV2	IMBALLO	
1	12	1/12 PG	



5 9 0 6 3 6 0 7 1 9 7 4 1



ART	BARCODE	ST.	PREZZO
04 93 55	5906360997101	A	2,25
20 TOVAGLIOLI 3 VELI 33X33CM 370000 'KITCHEN' PAW			
UV1	UV2	IMBALLO	
1	12	1/12 PG	



5 9 0 6 3 6 0 9 9 7 1 0 1



ART	BARCODE	ST.	PREZZO
04 92 09	5906360646672		2,25
20 TOVAGLIOLI 3 VELI 33X33CM 125100 'KITCHEN' PAW			
UV1	UV2	IMBALLO	
1	12	1/12 PG	



5 9 0 6 3 6 0 6 4 6 6 7 2



ART	BARCODE	ST.	PREZZO
04 93 74	5906360331219	A	2,25
20 TOVAGLIOLI 3 VELI 33X33CM 062100 'KITCHEN' PAW			
UV1	UV2	IMBALLO	
1	12	1/12 PG	



5 9 0 6 3 6 0 3 3 1 2 1 9



ART	BARCODE	ST.	PREZZO
04 92 37	5906360060003		2,25
20 TOVAGLIOLI 3 VELI 33X33CM 196000 'PARTY' PAW			
UV1	UV2	IMBALLO	
1	12	1/12 PG	



5 9 0 6 3 6 0 0 6 0 0 0 3



ART	BARCODE	ST.	PREZZO
04 93 99	5906360414745		2,25
20 TOVAGLIOLI 3 VELI 33X33CM 120127 'PARTY' PAW			
UV1	UV2	IMBALLO	
1	12	1/12 PG	



5 9 0 6 3 6 0 4 1 4 7 4 5



ART	BARCODE	ST.	PREZZO
04 91 85	5906360889574	A	2,25
20 TOVAGLIOLI 3 VELI 33X33CM 124100 'PARTY' PAW			
UV1	UV2	IMBALLO	
1	12	1/12 PG	



5 9 0 6 3 6 0 8 8 9 5 7 4



ART	BARCODE	ST.	PREZZO
04 91 87	5906360310788		2,25
20 TOVAGLIOLI 3 VELI 33X33CM 010300 'PARTY' PAW			
UV1	UV2	IMBALLO	
1	12	1/12 PG	



5 9 0 6 3 6 0 3 1 0 7 8 8



ART	BARCODE	ST.	PREZZO
04 92 59	5906360999556	A	1,20
20 TOVAGLIOLI 3 VELI 33X33CM 'NAVY BLUE' UNICOLOR PAW			
UV1	UV2	IMBALLO	
1	12	1/12 PG	



5 9 0 6 3 6 0 9 9 9 5 5 6



ART	BARCODE	ST.	PREZZO
04 98 00	8004537498004	A	1,50
CONFEZIONE 20 TOVAGLIOLI ASSORTITI IN DISPLAY			
UV1	UV2	IMBALLO	
12	36	12/12 DB	



8 0 0 4 5 3 7 4 9 8 0 0 4

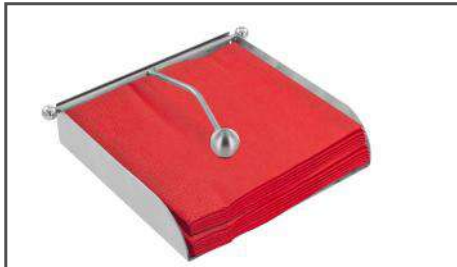

ART	BARCODE	ST.	PREZZO
07 02 55	8004537702552	A	7,50

PORTATOVAGLIOLI INOX 17X17CM EVA

UV1	UV2	IMBALLO
1	4	1/16 PB



KAUFGUT[®]



Bilance - Waagen

Bilance Da Cucina Analogiche



ART	BARCODE	ST.	PREZZO
03 30 01*	8004537330014		5,50

BILANCIA DIETA 116 BIANCO 500G/5G EVA

UV1	UV2	IMBALLO
1	6	1/6/48 PB



8 0 0 4 5 3 7 3 3 0 0 1 4



ART	BARCODE	ST.	PREZZO
03 30 11	8004537330113		6,95

BILANCIA CUCINA 1000 BIANCO 1KG/5G EVA

UV1	UV2	IMBALLO
1	6	1/6/48 PB



8 0 0 4 5 3 7 3 3 0 1 1 3



ART	BARCODE	ST.	PREZZO
03 30 22	8004537330229		8,50

BILANCIA CUCINA BIANCO 3KG/10G EVA

UV1	UV2	IMBALLO
1	6	1/6/24 PB



8 0 0 4 5 3 7 3 3 0 2 2 9



ART	BARCODE	ST.	PREZZO
03 30 32*	8004537330328		9,75

BILANCIA CUCINA BIANCO 5KG/20G EVA

UV1	UV2	IMBALLO
1	6	1/6/24 PB



8 0 0 4 5 3 7 3 3 0 3 2 8



ART	BARCODE	ST.	PREZZO
03 30 41	8004537330410		14,20

BILANCIA CUCINA 10000 BIANCO 10KG/50G EVA

UV1	UV2	IMBALLO
1	6	1/6/24 PB



8 0 0 4 5 3 7 3 3 0 4 1 0



ART	BARCODE	ST.	PREZZO
03 30 92	8004537330922		14,95

BILANCIA CUCINA ABS BIANCO 3KG/20G EVA

UV1	UV2	IMBALLO
1	6	1/12 PB



8 0 0 4 5 3 7 3 3 0 9 2 2



ART	BARCODE	ST.	PREZZO
03 30 52	8004537330526		25,80

BILANCIA CUCINA '5500' ACCIAIO INOSSIDABILE 5KG/20G EVA

UV1	UV2	IMBALLO
1	8	1/8 PB



8 0 0 4 5 3 7 3 3 0 5 2 6



ART	BARCODE	ST.	PREZZO
03 30 59*	8004537330595		14,95

BILANCIA CUCINA COLORI ASSORTITI 3KG/10G EVA

UV1	UV2	IMBALLO
1	6	1/6/12 PB



8 0 0 4 5 3 7 3 3 0 5 9 5



ART	BARCODE	ST.	PREZZO
03 30 51*	8004537330519		24,80

BILANCIA CUCINA '3500' ACCIAIO INOSSIDABILE 3KG/10G EVA

UV1	UV2	IMBALLO
1	8	1/8 PB



8 0 0 4 5 3 7 3 3 0 5 1 9



ART	BARCODE	ST.	PREZZO
03 32 48	8004537332483		23,50

BILANCIA MULTIUSO ACCIAIO INOSSIDABILE BLU 20KG/100G EVA

UV1	UV2	IMBALLO
1	6	1/6 LB



8 0 0 4 5 3 7 3 3 2 4 8 3

Bilance Da Cucina Digitali



ART	BARCODE	ST.	PREZZO
03 33 82	8004537333824		18,95

**BILANCIA CUCINA DIGITALE ACCIAIO
INOSSIDABILE 20KG/1G EVA**

UV1	UV2	IMBALLO
1	10	1/20 PB



8 0 0 4 5 3 7 3 3 3 8 2 4



ART	BARCODE	ST.	PREZZO
03 34 75	8004537334753		14,50

**BILANCIA CUCINA DIGITALE
INOX+GANCIO 15KG/1G EVA**

UV1	UV2	IMBALLO
1	5	1/20 PB



8 0 0 4 5 3 7 3 3 3 4 7 5 3



ART	BARCODE	ST.	PREZZO
03 34 69	8004537334692		37,20

**BILANCIA CUCINA DIGITALE ACCIAIO
INOSSID/LED 15KG/1G EVA**

UV1	UV2	IMBALLO
1	5	1/5 PB



8 0 0 4 5 3 7 3 3 3 4 6 9 2



ART	BARCODE	ST.	PREZZO
03 34 55	8004537334555		23,50

**BILANCIA CUCINA DIGITALE INOX
15KG/1G EVA**

UV1	UV2	IMBALLO
1	8	1/8 PB



8 0 0 4 5 3 7 3 3 3 4 5 5 5



ART	BARCODE	ST.	PREZZO
03 33 75	8004537333756		15,90

**BILANCIA CUCINA DIGITALE VETRO
BIANCO 15KG/1G EVA**

UV1	UV2	IMBALLO
1	12	1/12 PB



8 0 0 4 5 3 7 3 3 3 3 7 5 6



ART	BARCODE	ST.	PREZZO
03 33 79	8004537333794		13,50

**BILANCIA CUCINA DIGITALE ACCIAIO
INOSSIDABILE 10KG/1G EVA**

UV1	UV2	IMBALLO
1	10	1/20 PB



8 0 0 4 5 3 7 3 3 3 3 7 9 4



ART	BARCODE	ST.	PREZZO
03 33 73	8004537333732		15,70

**BILANCIA CUCINA DIGITALE VETRO
ARGENTO 10KG/1G EVA**

UV1	UV2	IMBALLO
1	5	1/10 PB



8 0 0 4 5 3 7 3 3 3 3 7 3 2



ART	BARCODE	ST.	PREZZO
03 34 72	8004537334722		18,90

**BILANCIA CUCINA DIGITALE ACCIAIO
INOSSID. BIANCO 6KG/1G EVA**

UV1	UV2	IMBALLO
1	6	1/24 PB



8 0 0 4 5 3 7 3 3 3 4 7 2 2



ART	BARCODE	ST.	PREZZO
03 33 44	8004537333442		11,50

**BILANCIA CUCINA DIGITALE ABS/VETRO
5KG/1G EVA**

UV1	UV2	IMBALLO
1	12	1/12 PB



8 0 0 4 5 3 7 3 3 3 3 4 4 2



ART	BARCODE	ST.	PREZZO
03 33 17	8004537333176		17,95

**BILANCIA CUCINA DIGITALE ABS/PS
ARGENTO 5KG/2G EVA**

UV1	UV2	IMBALLO
1	8	1/8 PB



8 0 0 4 5 3 7 3 3 3 3 1 7 6



ART	BARCODE	ST.	PREZZO
03 33 47	8004537333473		16,95

**BILANCIA CUCINA DIGITALE '5584'
ABS/PP ARGENTO 5KG/1G EVA**

UV1	UV2	IMBALLO
1	12	1/12 PB



8 0 0 4 5 3 7 3 3 3 3 4 7 3



ART	BARCODE	ST.	PREZZO
03 33 66*	8004537333664		17,40

**BILANCIA CUCINA DIGITALE '5501'
ABS/PS ARGENTO 5KG/1G EVA**

UV1	UV2	IMBALLO
1	6	1/6 PB



8 0 0 4 5 3 7 3 3 3 3 6 6 4



ART	BARCODE	ST.	PREZZO
03 33 48	8004537333480		25,50

BILANCIA CUCINA DIGITALE '5583'
ACCIAIO INOSSIDAB.5KG/1G EVA

UV1	UV2	IMBALLO
1	6	1/12 PB



8 0 0 4 5 3 7 3 3 3 4 8 0



ART	BARCODE	ST.	PREZZO
03 33 55	8004537333558		42,50

BILANCIA CUCINA DIGITALE
BIANCO/ACCIAIO INOSSIDAB 5KG/1G
EVA

UV1	UV2	IMBALLO
1	8	1/8 PB



8 0 0 4 5 3 7 3 3 3 5 5 8



ART	BARCODE	ST.	PREZZO
03 34 23	8004537334234		13,30

BILANCIA CUCINA DIGITALE ABS BIANCO
5KG/1G EVA

UV1	UV2	IMBALLO
1	6	1/6 PB



8 0 0 4 5 3 7 3 3 4 2 3 4



ART	BARCODE	ST.	PREZZO
03 33 38	8004537333381		12,90

BILANCIA CUCINA DIGITALE ABS BIANCA
5KG/1G EVA

UV1	UV2	IMBALLO
1	5	1/20 PB



8 0 0 4 5 3 7 3 3 3 3 8 1



ART	BARCODE	ST.	PREZZO
03 33 39	8004537333398		13,50

BILANCIA CUCINA DIGITALE ABS SILVER
5KG/1G EVA

UV1	UV2	IMBALLO
1	5	1/20 PB



8 0 0 4 5 3 7 3 3 3 3 9 8



ART	BARCODE	ST.	PREZZO
03 33 40	8004537333404		12,90

BILANCIA CUCINA DIGITALE ABS ROSSA
5KG/1G EVA

UV1	UV2	IMBALLO
1	5	1/20 PB



8 0 0 4 5 3 7 3 3 3 4 0 4



ART	BARCODE	ST.	PREZZO
03 34 34	8004537333430	A	13,50

BILANCIA CUCINA DIGITALE ABS/PS
BIANCO 5KG/1G EVA

UV1	UV2	IMBALLO
1	6	1/12 PB



8 0 0 4 5 3 7 3 3 3 4 3 0



ART	BARCODE	ST.	PREZZO
03 33 65	8004537333657		13,50

BILANCIA CUCINA DIGITALE ABS BIANCO
5KG/1G EVA

UV1	UV2	IMBALLO
1	8	1/8 PB



8 0 0 4 5 3 7 3 3 3 6 5 7



ART	BARCODE	ST.	PREZZO
03 33 37	8004537333374		14,50

BILANCIA CUCINA DIGITALE ABS/PP
COLORI ASSORTITI 5KG/1G EVA

UV1	UV2	IMBALLO
1	6	1/6/24 PB



8 0 0 4 5 3 7 3 3 3 3 7 4



ART	BARCODE	ST.	PREZZO
03 33 35	8004537333350		15,50

BILANCIA CUCINA DIGITALE COLORI
ASSORTITI/TRASP. 5KG/1G EVA

UV1	UV2	IMBALLO
1	6	1/6/24 PB



8 0 0 4 5 3 7 3 3 3 3 5 0



ART	BARCODE	ST.	PREZZO
03 33 81	8004537333817		14,95

BILANCIA CUCINA DIGITALE ACCIAIO
INOSSIDABILE 10KG/1G EVA

UV1	UV2	IMBALLO
1	12	1/12 PB



8 0 0 4 5 3 7 3 3 3 8 1 7



ART	BARCODE	ST.	PREZZO
03 33 80	8004537333800		21,50

BILANCIA CUCINA DIGITALE ACCIAIO
INOSSIDABILE 10KG/1G EVA

UV1	UV2	IMBALLO
1	10	1/20 PB



8 0 0 4 5 3 7 3 3 3 8 0 0



ART	BARCODE	ST.	PREZZO
03 33 68	8004537333688		15,70

**BILANCIA CUCINA DIGITALE ACCIO
INOSSIDABILE 5KG/1G EVA**

UV1	UV2	IMBALLO
1	6	1/12 PB



8 0 0 4 5 3 7 3 3 3 6 8 8



ART	BARCODE	ST.	PREZZO
03 33 25*	8004537333251		12,90

**BILANCIA CUCINA DIGITALE VETRO
ARANCIA 5KG/1G EVA**

UV1	UV2	IMBALLO
1	10	1/20 PB



8 0 0 4 5 3 7 3 3 3 2 5 1



ART	BARCODE	ST.	PREZZO
03 33 10	8004537333107		27,90

**BILANCIA DA CUCINA CINETICA BIANCA
5KG/1G EVA**

UV1	UV2	IMBALLO
1	5	1/10 PB



8 0 0 4 5 3 7 3 3 3 1 0 7



ART	BARCODE	ST.	PREZZO
03 32 96	8004537332964		51,50

**BILANCIA DA TAVOLO DIGITALE
3KG/0.1G EVA**

UV1	UV2	IMBALLO
1	4	1/12 PB



8 0 0 4 5 3 7 3 3 2 9 6 4



ART	BARCODE	ST.	PREZZO
03 33 46	8004537333466		17,50

**BILANCIA CUCINA DIGITALE ABS/PS
COLORI ASSORTITI 3KG/1G EVA**

UV1	UV2	IMBALLO
1	6	1/6/24 PB



8 0 0 4 5 3 7 3 3 3 4 6 6



ART	BARCODE	ST.	PREZZO
03 34 18	8004537334180		12,90

**BILANCIA CUCINA DIGITALE ABS/AL
BIANCO/ALLUMINIO 3 KG/1G EVA**

UV1	UV2	IMBALLO
1	6	1/6/24 PB



8 0 0 4 5 3 7 3 3 4 1 8 0



ART	BARCODE	ST.	PREZZO
03 33 14	8004537733143		14,40

**BILANCIA DI CUCINA/PRECISIONE DIG.
ABS BIANCO 3KG/0,2-1G EVA**

UV1	UV2	IMBALLO
1	12	1/12 PB



8 0 0 4 5 3 7 7 3 3 1 4 3



ART	BARCODE	ST.	PREZZO
03 33 96	8004537333961	A	19,90

**BILANCIA A PARETE DIGITALE+
TERMOMETRO ARGENTO 3KG/1G EVA**

UV1	UV2	IMBALLO
1	6	1/6 PB



8 0 0 4 5 3 7 3 3 3 9 6 1

Pesapersona Analogiche



ART	BARCODE	ST.	PREZZO
03 35 34	8004537335347		14,50

**PESAPERSONE '621' ABS BIANCO
120KG/1KG EVA**

UV1	UV2	IMBALLO
1	6	1/6 WB



8 0 0 4 5 3 7 3 3 5 3 4 7



ART	BARCODE	ST.	PREZZO
03 35 21	8004537335217		12,50

**PESAPERSONE '610' PP BIANCO
120KG/1KG EVA**

UV1	UV2	IMBALLO
1	6	1/6 WB



8 0 0 4 5 3 7 3 3 5 2 1 7



ART	BARCODE	ST.	PREZZO
03 35 40	8004537335408	A	9,95

**PESAPERSONE ABS BIANCA 130KG/1KG
EVA**

UV1	UV2	IMBALLO
1	10	1/10 WB



8 0 0 4 5 3 7 3 3 5 4 0 8



ART	BARCODE	ST.	PREZZO
03 35 11	8004537335118		20,80

PESAPERSONE NERA 130KG/1KG EVA

UV1	UV2	IMBALLO
1	5	1/10 WB



8 0 0 4 5 3 7 3 3 5 1 1 8



ART	BARCODE	ST.	PREZZO
03 35 94*	8004537335941		37,50

**PESAPERSONE '893' NERO 150KG/500G
EVA**

UV1	UV2	IMBALLO
1	3	1/3 PB



8 0 0 4 5 3 7 3 3 5 9 4 1

Pesapersona Digitali



ART	BARCODE	ST.	PREZZO
03 37 32	8004537337327	A	14,50

**PESAPERSONE BODY FAT NERO
180KG/100G EVA**

UV1	UV2	IMBALLO
1	10	1/10 PB



8 0 0 4 5 3 7 3 3 7 3 2 7



ART	BARCODE	ST.	PREZZO
03 36 04	8004537336047		29,90

**PESAPERSONE VETRO NERO
180KG/100G EVA**

UV1	UV2	IMBALLO
1	6	1/6 PB



8 0 0 4 5 3 7 3 3 6 0 4 7



ART	BARCODE	ST.	PREZZO
03 36 03*	8004537336030		25,00

**PESAPERSONE DIGITALE VETRO NERO
200KG/100G EVA**

UV1	UV2	IMBALLO
1	4	1/4 PB



8 0 0 4 5 3 7 3 3 6 0 3 0



ART	BARCODE	ST.	PREZZO
03 36 90*	8004537336900		14,40

**PESAPERSONE VETRO
BIANCO/ALLUMINIO 180KG/100G EVA**

UV1	UV2	IMBALLO
1	6	1/6 PB



8 0 0 4 5 3 7 3 3 6 9 0 0



ART	BARCODE	ST.	PREZZO
03 36 95*	8004537336955		14,40

**PESAPERSONE VETRO NERO/ALLUMINIO
180KG/100G EVA**

UV1	UV2	IMBALLO
1	6	1/6 PB



8 0 0 4 5 3 7 3 3 6 9 5 5



ART	BARCODE	ST.	PREZZO
03 37 09	8004537337099		12,00

**PESAPERSONE VETRO NERO 180KG/50G
EVA**

UV1	UV2	IMBALLO
1	5	1/10 PB



8 0 0 4 5 3 7 3 3 7 0 9 9



ART	BARCODE	ST.	PREZZO
03 37 10	8004537337105		12,00

**PESAPERSONE VETRO SILVER
180KG/50G EVA**

UV1	UV2	IMBALLO
1	5	1/10 PB



8 0 0 4 5 3 7 3 3 7 1 0 5



ART	BARCODE	ST.	PREZZO
03 37 01	8004537337013		12,00

**PESAPERSONE VETRO BIANCO
180KG/50G EVA**

UV1	UV2	IMBALLO
1	5	1/10 PB



8 0 0 4 5 3 7 3 3 7 0 1 3



ART	BARCODE	ST.	PREZZO
03 37 02	8004537337020		12,00

**PESAPERSONE VETRO ROSSO
150KG/100G EVA**

UV1	UV2	IMBALLO
1	5	1/10 PB



8 0 0 4 5 3 7 3 3 7 0 2 0



ART	BARCODE	ST.	PREZZO
03 36 20	8004537336207		19,90

**PESAPERSONE DIGITALE ABS BIANCO
150KG/100G EVA**

UV1	UV2	IMBALLO
1	6	1/6 PB



8 0 0 4 5 3 7 3 3 6 2 0 7



ART	BARCODE	ST.	PREZZO
03 36 54	8004537336542		23,00

**PESAPERS DIGITALE ABS
BIANCO150KG/100G EVA**

UV1	UV2	IMBALLO
1	6	1/6 PB



8 0 0 4 5 3 7 3 3 6 5 4 2

Pesapacchi



ART	BARCODE	ST.	PREZZO
03 32 93	8004537332933		77,50

BILANCIA PESAPACCHI DIGITALE ACCIAIO INOSSIDAB.150KG/50G EVA

UV1	UV2	IMBALLO
1	4	1/4 PB



8 0 0 4 5 3 7 3 3 2 9 3 3



ART	BARCODE	ST.	PREZZO
03 32 94*	8004537332940		63,50

BILANCIA PESAPACCHI DIGITALE ACCIAIO INOSSID. 50KG/2G EV

UV1	UV2	IMBALLO
1	4	1/4 PB



8 0 0 4 5 3 7 3 3 2 9 4 0



ART	BARCODE	ST.	PREZZO
03 32 92	8004537332926		179,50

BILANCIA PESAPACCHI DIGITALE '9902' INOX 50KG/5-10-20G EVA

UV1	UV2	IMBALLO
1	2	1/1 LB



8 0 0 4 5 3 7 3 3 2 9 2 6



ART	BARCODE	ST.	PREZZO
03 32 91	8004537332919		107,50

BILANCIA PESAPACCHI DIGITALE '9901' INOX 30KG/1-2-5-10G EVA

UV1	UV2	IMBALLO
1	4	1/4 PB



8 0 0 4 5 3 7 3 3 2 9 1 9



ART	BARCODE	ST.	PREZZO
03 32 90	8004537332902		102,50

BILANCIA PESAPACCHI DIGITALE '9901' INOX 20KG/1-2-5-10G EVA

UV1	UV2	IMBALLO
1	4	1/4 PB



8 0 0 4 5 3 7 3 3 2 9 0 2

Bilance Speciali



ART	BARCODE	ST.	PREZZO
03 32 72*	8004537332728	A	5,30

PESA-BAGAGLIO NERA 40KG/10G EVA

UV1	UV2	IMBALLO
1	10	1/84 DC



8 0 0 4 5 3 7 3 3 2 7 2 8



ART	BARCODE	ST.	PREZZO
03 32 83*	8004537332834	H	37,50

**PESA NEONATI DIGITALE ABS/PP
20KG/5G EVA**

UV1	UV2	IMBALLO
1	4	1/4 PB



8 0 0 4 5 3 7 3 3 2 8 3 4



ART	BARCODE	ST.	PREZZO
03 33 01*	8004537333015		9,80

**BILANCIA TASCABILE DIGITALE
200G/0,01G EVA**

UV1	UV2	IMBALLO
1	6	1/6/48 HB



8 0 0 4 5 3 7 3 3 3 0 1 5



ART	BARCODE	ST.	PREZZO
03 33 08	8004537333084		11,30

**BILANCIA TASCABILE DIGITALE
200G/0,1G EVA**

UV1	UV2	IMBALLO
1	6	1/6/48 PB



8 0 0 4 5 3 7 3 3 3 0 8 4



ART	BARCODE	ST.	PREZZO
03 33 07	8004537333077	A	9,70

**BILANCIA TASCABILE DIGITALE
500G/0,1G EVA**

UV1	UV2	IMBALLO
1	6	1/6/48 PB



8 0 0 4 5 3 7 3 3 3 0 7 7



ART	BARCODE	ST.	PREZZO
03 33 95*	8004537333954	H	11,50

**BILANCIA CUCCHIAIO DIGITALE '5225'
ABS ARGENTO 300G/0,1G EVA**

UV1	UV2	IMBALLO
1	5	1/40 PB



8 0 0 4 5 3 7 3 3 3 9 5 4

KAUFGUT[®]



Electrodomestici - Elektrokleingeräte

Frullare Mescolare Impastare



ART	BARCODE	ST.	PREZZO
02 53 03*	4004470035001		26,50

SBATTITORE 'HM350CB' 250W BOMANN

UV1	UV2	IMBALLO
1	6	1/6 PB



4 0 0 4 4 7 0 0 3 5 0 0 1



ART	BARCODE	ST.	PREZZO
02 21 10	4004094247668		13,90

SCHIUMALATTE 'BRASILIA' WESTMARK

UV1	UV2	IMBALLO
1	4	1/4/40 PB



4 0 0 4 0 9 4 2 4 7 6 6 8



ART	BARCODE	ST.	PREZZO
12 22 25	8033237337535		3,70

SCHIUMALATTE FOREVER

UV1	UV2	IMBALLO
1	6	1/12/72 HB



8 0 3 3 2 3 7 3 3 7 5 3 5



ART	BARCODE	ST.	PREZZO
02 53 04	4004470034417		5,50

SCHIUMALATTE 'MS344CB' BOMANN

UV1	UV2	IMBALLO
1	20	1/20 PB



4 0 0 4 4 7 0 0 3 4 4 1 7



ART	BARCODE	ST.	PREZZO
02 53 32*	4004470035407		20,90

FRULLATORE IMMERSIONE "SM354CB" 180W BOMANN

UV1	UV2	IMBALLO
1	12	1/12 PB



4 0 0 4 4 7 0 0 3 5 4 0 7



ART	BARCODE	ST.	PREZZO
02 53 15*	4004470602814		37,50

FRULLATORE IMMERSIONE 'SM602CB' ACCIAIO INOSSID 800 W BOMANN

UV1	UV2	IMBALLO
1	6	1/6 PB



4 0 0 4 4 7 0 6 0 2 8 1 4



ART	BARCODE	ST.	PREZZO
02 80 86*	4006160010947		48,50

FRULLATORE IMMERSIONE 'SM1094' INOX 1000W PROFICOOK

UV1	UV2	IMBALLO
1	4	1/4 PB



4 0 0 6 1 6 0 0 1 0 9 4 7



ART	BARCODE	ST.	PREZZO
02 53 24	4004470034912		42,50

FRULLATORE IMMERSIONE SET 3IN1 'SMS349CB' 200W BOMANN

UV1	UV2	IMBALLO
1	6	1/6 PB



4 0 0 4 4 7 0 0 3 4 9 1 2



ART	BARCODE	ST.	PREZZO
02 53 40*	4004470037807		47,50

FRULLATORE 'UM378CB' BIANCO 500W BOMANN

UV1	UV2	IMBALLO
1	2	1/4 PB



4 0 0 4 4 7 0 0 3 7 8 0 7



ART	BARCODE	ST.	PREZZO
02 80 89	4006160012132		50,00

FRULLATORE 'UM1213' INOX 20.000 G/MIN 1,0L 500W PROFICOOK

UV1	UV2	IMBALLO
1	3	1/3 PB



4 0 0 6 1 6 0 0 1 2 1 3 2



ART	BARCODE	ST.	PREZZO
02 80 23	4006160119541		85,00

FRULLATORE VINTAGE 'UM1195' ROSSO 1.5L 800W PROFICOOK

UV1	UV2	IMBALLO
1	2	1/2 PB



4 0 0 6 1 6 0 1 1 9 5 4 1



ART	BARCODE	ST.	PREZZO
02 80 28	4006160119558		85,00

FRULLATORE VINTAGE 'UM1195' ANTRACITE 1.5L 800W PROFICOOK

UV1	UV2	IMBALLO
1	2	1/2 PB



4 0 0 6 1 6 0 1 1 9 5 5 8



ART	BARCODE	ST.	PREZZO
02 80 90	4006160100655		125,00

**FRULLATORE 'UM1006' INOX 20.000 G/MIN
1,8L 1200W PROFICOOK**

UV1	UV2	IMBALLO
1	2	1/2 PB



4 0 0 6 1 6 0 1 0 0 6 5 5



ART	BARCODE	ST.	PREZZO
02 30 25	4006160635850	A	41,50

**MIXER DA BAR 'BM3472' 650ML 65W
CLATRONIC**

UV1	UV2	IMBALLO
1	6	1/6 PB



4 0 0 6 1 6 0 6 3 5 8 5 0



ART	BARCODE	ST.	PREZZO
02 81 34	4006160106312		133,50

**ROBOT DA CUCINA 3IN1 'KM1063' 1200W
PROFICOOK**

UV1	UV2	IMBALLO
1	2	1/2 PB



4 0 0 6 1 6 0 1 0 6 3 1 2



ART	BARCODE	ST.	PREZZO
02 53 50	4004470603613		290,00

**IMPASTATRICE 'KM6036CB' TITANIO
1500W BOMANN**

UV1	UV2	IMBALLO
1	2	1/1 PB



4 0 0 4 4 7 0 6 0 3 6 1 3



ART	BARCODE	ST.	PREZZO
02 53 51	4004470601015		157,50

**IMPASTATRICE 'KM6010CB' TITANIO
1100W BOMANN**

UV1	UV2	IMBALLO
1	2	1/1 PB



4 0 0 4 4 7 0 6 0 1 0 1 5



ART	BARCODE	ST.	PREZZO
02 53 53	4004470039801		175,00

**IMPASTATRICE 'KM398CB' TITANIO
1200W BOMANN**

UV1	UV2	IMBALLO
1	2	1/1 PB



4 0 0 4 4 7 0 0 3 9 8 0 1



ART	BARCODE	ST.	PREZZO
02 81 35	4006160010961		399,00

**IMPASTATRICE 'KM1096' 10L 1500W
PROFICOOK**

UV1	UV2	IMBALLO
1	2	1/1 PB



4 0 0 6 1 6 0 0 1 0 9 6 1

Tritare Grattugiare Spremere



ART	BARCODE	ST.	PREZZO
02 80 84*	4006160102925		29,50

MACINACAFFÉ 'KSW 1216' 150W
PROFICOOK

UV1	UV2	IMBALLO
1	4	1/4 PB



4 0 0 6 1 6 0 1 0 2 9 2 5



ART	BARCODE	ST.	PREZZO
02 54 13	4004470044607		23,50

MACINACAFFÉ 'KSW446CB' 120W
BOMANN

UV1	UV2	IMBALLO
1	6	1/6 PB



4 0 0 4 4 7 0 0 4 4 6 0 7



ART	BARCODE	ST.	PREZZO
02 80 82	4006160102123		44,50

MACINACAFFÉ 'KSW1021' 200W
PROFICOOK

UV1	UV2	IMBALLO
1	4	1/4 PB



4 0 0 6 1 6 0 1 0 2 1 2 3



ART	BARCODE	ST.	PREZZO
02 80 79*	4006160120509		107,50

MACINACAFFÉ ELETTRICO EKM 1205'
200W PROFICOOK

UV1	UV2	IMBALLO
1	2	1/2 PB



4 0 0 6 1 6 0 1 2 0 5 0 9



ART	BARCODE	ST.	PREZZO
02 80 81	4006160115000		44,50

MINI TRITATUTTO 'MZ1150' ACCIAIO
INOSSIDABILE 400W PROFICOOK

UV1	UV2	IMBALLO
1	4	1/4 PB



4 0 0 6 1 6 0 1 1 5 0 0 0



ART	BARCODE	ST.	PREZZO
02 53 18*	4004470044904		31,50

MULTI-TRITATUTTO 'MZ449CB' BIANCO
250W BOMANN

UV1	UV2	IMBALLO
1	6	1/6 PB



4 0 0 4 4 7 0 0 4 4 9 0 4



ART	BARCODE	ST.	PREZZO
02 54 23*	4004470109207		23,50

SPREMIAGRUMI 'ZP1092CB' 40W
BOMANN

UV1	UV2	IMBALLO
1	6	1/6 PB



4 0 0 4 4 7 0 1 0 9 2 0 7



ART	BARCODE	ST.	PREZZO
02 81 15	4006160101812		50,50

SPREMIAGRUMI 'ZP1018' ACCIAIO
INOSSIDABILE 100W PROFICOOK

UV1	UV2	IMBALLO
1	4	1/4 PB



4 0 0 6 1 6 0 1 0 1 8 1 2



ART	BARCODE	ST.	PREZZO
02 81 14	4006160115437		85,00

SPREMIAGRUMI 'ZP1154' ACCIAIO
INOSSIDABILE 160W PROFICOOK

UV1	UV2	IMBALLO
1	2	1/2 PB



4 0 0 6 1 6 0 1 1 5 4 3 7



ART	BARCODE	ST.	PREZZO
02 56 14	4004470191813	A	61,50

CENTRIFUGA 'AE1915CB' ACCIAIO
INOSSIDABILE 400W BOMANN

UV1	UV2	IMBALLO
1	4	1/4 PB



4 0 0 4 4 7 0 1 9 1 8 1 3



ART	BARCODE	ST.	PREZZO
02 56 15	4004470191714		89,50

CENTRIFUGA 'AE1917CB' ACCIAIO
INOSSIDABILE 1000W BOMANN

UV1	UV2	IMBALLO
1	2	1/2 PB



4 0 0 4 4 7 0 1 9 1 7 1 4



ART	BARCODE	ST.	PREZZO
02 56 16*	4004470102802	H	53,50

CENTRIFUGA 'AE1028CB' 400W BOMANN

UV1	UV2	IMBALLO
1	4	1/4 PB



4 0 0 4 4 7 0 1 0 2 8 0 2



ART	BARCODE	ST.	PREZZO
02 80 94	4006160114102	A	149,50

**SLOW JUICER 'SJ 1141' 150W
PROFICOOK**

UV1	UV2	IMBALLO
1	2	1/2 PB



4 0 0 6 1 6 0 1 1 4 1 0 2



ART	BARCODE	ST.	PREZZO
02 54 38	4004470044713		93,50

**TRITACARNE 'FW447CB' ACCIAIO
INOSSIDABILE 1200W BOMANN**

UV1	UV2	IMBALLO
1	2	1/4 PB



4 0 0 4 4 7 0 0 4 4 7 1 3



ART	BARCODE	ST.	PREZZO
02 81 33	4006160011739		210,00

**TRITACARNE INOX 'FW 1176' 2000W
PROFICOOK**

UV1	UV2	IMBALLO
1	2	1/2 PB



4 0 0 6 1 6 0 0 1 1 7 3 9

Essicare Cottura a vapore



ART	BARCODE	ST.	PREZZO
02 30 40	4006160617672		51,00

ESSICCATORE+5 SETACCI DR 2751
CLATRONIC

UV1	UV2	IMBALLO
1	4	1/4 PB



4 0 0 6 1 6 0 6 1 7 6 7 2



ART	BARCODE	ST.	PREZZO
02 81 79	4006160011265		125,00

MACCHINA COTTURA SOTTOVUOTO
'SV1126' 800W PROFICOOK

UV1	UV2	IMBALLO
1	2	1/2 PB



4 0 0 6 1 6 0 0 1 1 2 6 5



ART	BARCODE	ST.	PREZZO
02 30 38	4006160632361		52,50

CUOCIRISO 'RK 3567' ACCIAIO
INOSSIDABILE 700W CLATRONIC

UV1	UV2	IMBALLO
1	2	1/2 PB



4 0 0 6 1 6 0 6 3 2 3 6 1



ART	BARCODE	ST.	PREZZO
02 54 45*	4004470616866		21,50

CUOCIUOVA 'EK5022CB' BIANCO 400W
BOMANN

UV1	UV2	IMBALLO
1	6	1/6 PB



4 0 0 4 4 7 0 6 1 6 8 6 6



ART	BARCODE	ST.	PREZZO
02 80 69*	4006160541250	A	18,50

CUOCIUOVA 'SINGLE EK1124' ACCIAIO
INOX 300W PROFICOOK

UV1	UV2	IMBALLO
1	4	1/4 PB



4 0 0 6 1 6 0 5 4 1 2 5 0



ART	BARCODE	ST.	PREZZO
02 80 68*	4006160501131	H	29,50

CUOCIUOVA 'EK1139' ACCIAIO
INOSSIDABILE 400W PROFICOOK

UV1	UV2	IMBALLO
1	4	1/4 PB



4 0 0 6 1 6 0 5 0 1 1 3 1



ART	BARCODE	ST.	PREZZO
02 80 70	4006160010848	A	34,50

CUOCIUOVA 'EK1084' ACCIAIO
INOSSIDABILE 400W PROFICOOK

UV1	UV2	IMBALLO
1	4	1/4 PB



4 0 0 6 1 6 0 0 1 0 8 4 8

**Raclette Grill Fondute Toaster Waffel
Bistecchiere**



ART	BARCODE	ST.	PREZZO
02 27 64	8004537227642	A	44,50

FONDUTA ELETTRICA ANTIADERENTE
800W 6P EVA

UV1	UV2	IMBALLO
1	3	1/6 PB



8 0 0 4 5 3 7 2 2 7 6 4 2



ART	BARCODE	ST.	PREZZO
02 30 52	4006160617047		63,50

FONDUTA ELETTRICA 'FD3516' INOX 8
PERSONE 1200W CLATRONIC

UV1	UV2	IMBALLO
1	4	1/4 PB



4 0 0 6 1 6 0 6 1 7 0 4 7



ART	BARCODE	ST.	PREZZO
02 27 68	8004537227680		94,50

RACLETTE+GRILL DOPPIO 'CORTINA'
1200W 8 PERSONE EVA

UV1	UV2	IMBALLO
1	3	1/3 PB



8 0 0 4 5 3 7 2 2 7 6 8 0



ART	BARCODE	ST.	PREZZO
02 27 80*	4006160639469		49,50

RACLETTE-GRILL 'RG 3757' 1400W
CLATRONIC

UV1	UV2	IMBALLO
1	3	1/3 PB



4 0 0 6 1 6 0 6 3 9 4 6 9



ART	BARCODE	ST.	PREZZO
02 27 98*	8004537227987	H	35,00

RACLETTE ROTONDA+GRILL 'RONDO'
900W 6P EVA

UV1	UV2	IMBALLO
1	4	1/4 PB



8 0 0 4 5 3 7 2 2 7 9 8 7



ART	BARCODE	ST.	PREZZO
02 27 99*	8004537227994	H	52,50

RACLETTE OVALE+GRILL 'SWISS' 1200W
8P EVA

UV1	UV2	IMBALLO
1	4	1/4 PB



8 0 0 4 5 3 7 2 2 7 9 9 4



ART	BARCODE	ST.	PREZZO
02 27 69	8004537227697		89,50

RACLETTE+PIETRA LIVIGNO 1200W 8
PERSONE EVA

UV1	UV2	IMBALLO
1	2	1/2 PB



8 0 0 4 5 3 7 2 2 7 6 9 7



ART	BARCODE	ST.	PREZZO
02 57 24*	4004470300611	A	92,50

GRILL SPIEDINI/POLLO/KEBAB 'DVG 3006'
1400W BOMANN

UV1	UV2	IMBALLO
1	2	1/2 PB



4 0 0 4 4 7 0 3 0 0 6 1 1



ART	BARCODE	ST.	PREZZO
02 81 61	4006160102918		119,50

BISTECCHIERA 'KG1029' 2000W
PROFICOOK

UV1	UV2	IMBALLO
1	2	1/2 PB



4 0 0 6 1 6 0 1 0 2 9 1 8



ART	BARCODE	ST.	PREZZO
02 27 88	4004470224214		79,50

BISTECCHIERA CONTATTO 'KG2242CB'
2000W BOMANN

UV1	UV2	IMBALLO
1	3	1/3 PB



4 0 0 4 4 7 0 2 2 4 2 1 4



ART	BARCODE	ST.	PREZZO
02 27 90*	4004470225112		34,50

BISTECCHIERA/GRILL 'MG2251CB'
ACCIAIO INOSSID. 700W BOMANN

UV1	UV2	IMBALLO
1	6	1/6 PB



4 0 0 4 4 7 0 2 2 5 1 1 2



ART	BARCODE	ST.	PREZZO
02 57 25	4004470124019		39,50

BARBECUE DA TAVOLO 'BSQ1240' 2000W
BOMANN

UV1	UV2	IMBALLO
1	4	1/4 PB



4 0 0 4 4 7 0 1 2 4 0 1 9



ART	BARCODE	ST.	PREZZO
02 51 01	4004470616798		29,00

MACCHINA CIALDE 'WA5018CB' BIANCA Ø 18CM 1200W BOMANN

UV1	UV2	IMBALLO
1	6	1/6 PB



4 0 0 4 4 7 0 6 1 6 7 9 8



ART	BARCODE	ST.	PREZZO
02 51 02	4004470616811		37,50

MACCHINA CIALDE 'WA1365CB' Ø 18CM 1000W BOMANN

UV1	UV2	IMBALLO
1	4	1/4 PB



4 0 0 4 4 7 0 6 1 6 8 1 1



ART	BARCODE	ST.	PREZZO
02 27 67	8004537227673	H	39,50

MACCHINA PER CREPES+GRILL 900W Ø35CM EVA

UV1	UV2	IMBALLO
1	4	1/4 PB



8 0 0 4 5 3 7 2 2 7 6 7 3



ART	BARCODE	ST.	PREZZO
02 30 54	4006160717051		37,50

MACCHINA CIALDE 'WA3606' 800W CLATRONIC

UV1	UV2	IMBALLO
1	4	1/4 PB



4 0 0 6 1 6 0 7 1 7 0 5 1



ART	BARCODE	ST.	PREZZO
02 80 76	4006160010923		39,80

SANDWICH TOASTER 'ST1092' ACCIAIO INOSSIDAB. 900W PROFICOOK

UV1	UV2	IMBALLO
1	4	1/4 PB



4 0 0 6 1 6 0 0 1 0 9 2 3



ART	BARCODE	ST.	PREZZO
02 51 43	4004470133905		28,90

TOSTAPANE A PINZE 'TAZ1339CB' 500W BOMANN

UV1	UV2	IMBALLO
1	6	1/6 PB



4 0 0 4 4 7 0 1 3 3 9 0 5



ART	BARCODE	ST.	PREZZO
02 80 75	4006160111026		66,50

TOSTAPANE 'TAZ1110' ACCIAIO INOSSIDABILE 1050W PROFICOOK

UV1	UV2	IMBALLO
1	4	1/4 PB



4 0 0 6 1 6 0 1 1 1 0 2 6



ART	BARCODE	ST.	PREZZO
02 80 72	4006160011708	H	53,50

TOSTAPANE 4CM 'TA1170' ACCIAIO INOSSIDABILE 920W PROFICOOK

UV1	UV2	IMBALLO
1	2	1/2 PB



4 0 0 6 1 6 0 0 1 1 7 0 8



ART	BARCODE	ST.	PREZZO
02 80 74	4006160107302		71,50

TOSTAPANE 4 FETTE 'TA1073' ACCIAIO INOSSIDAB.1500W PROFICOOK

UV1	UV2	IMBALLO
1	2	1/2 PB



4 0 0 6 1 6 0 1 0 7 3 0 2



ART	BARCODE	ST.	PREZZO
02 80 73	4006160108217	A	42,50

TOSTAPANE 'TA1082' ACCIAIO INOSSIDABILE 800W PROFICOOK

UV1	UV2	IMBALLO
1	4	1/4 PB



4 0 0 6 1 6 0 1 0 8 2 1 7



ART	BARCODE	ST.	PREZZO
02 80 22	4006160119404		99,50

TOSTAPANE VINTAGE 4 FETTE 'TA1194' ROSSO 1630W PROFICOOK

UV1	UV2	IMBALLO
1	2	1/2 PB



4 0 0 6 1 6 0 1 1 9 4 0 4



ART	BARCODE	ST.	PREZZO
02 80 27	4006160119411		99,50

TOSTAPANE VINTAGE 4 FETTE 'TA1194' ANTRACITE 1630W PROFICOOK

UV1	UV2	IMBALLO
1	2	1/2 PB



4 0 0 6 1 6 0 1 1 9 4 1 1



ART	BARCODE	ST.	PREZZO
02 80 21	4006160119305		82,50

**TOSTAPANE VINTAGE 'TA1193' ROSSO
815W PROFICOOK**

UV1	UV2	IMBALLO
1	2	1/2 PB



4 0 0 6 1 6 0 1 1 9 3 0 5



ART	BARCODE	ST.	PREZZO
02 80 26	4006160119312		82,50

**TOSTAPANE VINTAGE 'TA1193'
ANTRACITE 815W PROFICOOK**

UV1	UV2	IMBALLO
1	2	1/2 PB



4 0 0 6 1 6 0 1 1 9 3 1 2

Microonde Friggitrice Forni



ART	BARCODE	ST.	PREZZO
02 81 76	4006160011753	A	185,00

MICROONDE CON GRILL 'PC-MWG 1175'
20L 800W PROFICOOK

UV1	UV2	IMBALLO
1	2	1/1 PB



4 0 0 6 1 6 0 0 1 1 7 5 3



ART	BARCODE	ST.	PREZZO
02 30 57	4006160645613		68,50

MINI FORNO 8 LITRI 'MB 3746' 650W
CLATRONIC

UV1	UV2	IMBALLO
1	2	1/2 PB



4 0 0 6 1 6 0 6 4 5 6 1 3



ART	BARCODE	ST.	PREZZO
02 57 75	4004470601411		125,00

MICROONDE 'MW6014CB' BIANCO 20L
700W BOMANN

UV1	UV2	IMBALLO
1	2	1/1 PB



4 0 0 4 4 7 0 6 0 1 4 1 1



ART	BARCODE	ST.	PREZZO
02 57 80	4004470601527		158,50

MICROONDE/GRILL 'MWG6015CB' SILVER
20L 700W BOMANN

UV1	UV2	IMBALLO
1	2	1/1 PB



4 0 0 4 4 7 0 6 0 1 5 2 7



ART	BARCODE	ST.	PREZZO
02 57 70*	4004470602319	A	149,50

FORNO MULTIUSO VENTILATO
'MBG6023CB' 30L 1500W BOMANN

UV1	UV2	IMBALLO
1	2	1/1 PB



4 0 0 4 4 7 0 6 0 2 3 1 9



ART	BARCODE	ST.	PREZZO
02 57 62	4004470226416		64,50

FRIGGITRICE 'FR2264CB' 3L 2000W
BOMANN

UV1	UV2	IMBALLO
1	2	1/2 PB



4 0 0 4 4 7 0 2 2 6 4 1 6



ART	BARCODE	ST.	PREZZO
02 30 45*	4006160735314		103,00

FRIGGITRICE DOPPIA "FR3195" ACCIAIO
INOSSIDAB.2000W CLATRONIC

UV1	UV2	IMBALLO
1	2	1/2 PB



4 0 0 6 1 6 0 7 3 5 3 1 4



ART	BARCODE	ST.	PREZZO
02 30 49*	4006160638189	H	145,00

FORNO PIZZA PER 6 PIZZE 'PO 3682'
1100W CLATRONIC

UV1	UV2	IMBALLO
1	2	1/1 PB



4 0 0 6 1 6 0 6 3 8 1 8 9

Macchine Da Caffè Bolliacqua



ART	BARCODE	ST.	PREZZO
02 80 20	4006160119206		82,50

BOLLIACQUA VINTAGE 'WKS1192' 1,7L
ROSSO 2200W PROFICOOK

UV1	UV2	IMBALLO
1	2	1/2 PB



4 0 0 6 1 6 0 1 1 9 2 0 6



ART	BARCODE	ST.	PREZZO
02 80 25	4006160119213		82,50

BOLLIACQUA VINTAGE 'WKS1192' 1,7L
ANTRACITE 2200W PROFICOOK

UV1	UV2	IMBALLO
1	2	1/2 PB



4 0 0 6 1 6 0 1 1 9 2 1 3



ART	BARCODE	ST.	PREZZO
02 30 18*	4006160637298		23,50

BOLLIACQUA 'WKR 3624' ACCIAIO
INOSSIDABILE 0,5L CLATRONIC

UV1	UV2	IMBALLO
1	6	1/6 PB



4 0 0 6 1 6 0 6 3 7 2 9 8



ART	BARCODE	ST.	PREZZO
02 80 42	4006160541274		39,80

BOLLIACQUA 'SINGLE WKS1123' INOX
0,8L 2000W PROFICOOK

UV1	UV2	IMBALLO
1	4	1/4 PB



4 0 0 6 1 6 0 5 4 1 2 7 4



ART	BARCODE	ST.	PREZZO
02 80 45	4006160011067		37,50

BOLLIACQUA 'WKS1106' INOX 1,0L 2200W
PROFICOOK

UV1	UV2	IMBALLO
1	4	1/4 PB



4 0 0 6 1 6 0 0 1 1 0 6 7



ART	BARCODE	ST.	PREZZO
02 30 19	4006160631791		29,50

BOLLIACQUA 'WKS 3381' ACCIAIO
INOSSIDABILE 1L 2200W CLATRONI

UV1	UV2	IMBALLO
1	6	1/6 PB



4 0 0 6 1 6 0 6 3 1 7 9 1



ART	BARCODE	ST.	PREZZO
02 52 33	4004470300215		26,50

BOLLIACQUA 'WK3002CB' NERO 1,5L
2200W BOMANN

UV1	UV2	IMBALLO
1	6	1/6 PB



4 0 0 4 4 7 0 3 0 0 2 1 5



ART	BARCODE	ST.	PREZZO
02 80 46	4006160011074		45,50

BOLLIACQUA 'WKS1107G' VETRO 1,5L
2200W PROFICOOK

UV1	UV2	IMBALLO
1	4	1/4 PB



4 0 0 6 1 6 0 0 1 1 0 7 4



ART	BARCODE	ST.	PREZZO
02 52 43	4004470502404		17,50

BOLLIACQUA 'WK5024CB' BIANCO 1,0L
900W BOMANN

UV1	UV2	IMBALLO
1	6	1/6 PB



4 0 0 4 4 7 0 5 0 2 4 0 4



ART	BARCODE	ST.	PREZZO
02 52 32	4004470300321		26,50

BOLLIACQUA 'WK3002CB' BIANCO 1,5L
2200W BOMANN

UV1	UV2	IMBALLO
1	6	1/6 PB



4 0 0 4 4 7 0 3 0 0 3 2 1



ART	BARCODE	ST.	PREZZO
02 52 47*	4004470604313		26,50

BOLLIACQUA 'WKS6043CB' ACCIAIO
INOSSIDABIL 1,7L 2200W BOMANN

UV1	UV2	IMBALLO
1	6	1/6 PB



4 0 0 4 4 7 0 6 0 4 3 1 3



ART	BARCODE	ST.	PREZZO
02 52 36*	4004470501100		21,00

BOLLIACQUA WK5011CB BIANCO 1,7L
2000W BOMANN

UV1	UV2	IMBALLO
1	6	1/6 PB



4 0 0 4 4 7 0 5 0 1 1 0 0



ART	BARCODE	ST.	PREZZO
02 52 46	4004470303216		29,50

BOLLIACQUA 'WK6032G CB' VETRO 1,7L 2200W BOMANN

UV1	UV2	IMBALLO
1	4	1/4 PB



4 0 0 4 4 7 0 3 0 3 2 1 6



ART	BARCODE	ST.	PREZZO
02 30 21	4006160638899		52,50

TEIERA 'TK 3715' VETRO 1 LITRO 720W CLATRONIC

UV1	UV2	IMBALLO
1	4	1/4 PB



4 0 0 6 1 6 0 6 3 8 8 9 9



ART	BARCODE	ST.	PREZZO
02 80 40	4006160011654	H	74,50

BOLLIACQUA/TEIERA "TK 1165" INOX/VETRO 0,5L 1100W PROFICOOK

UV1	UV2	IMBALLO
1	2	1/2 PB



4 0 0 6 1 6 0 0 1 1 6 5 4



ART	BARCODE	ST.	PREZZO
02 50 01	4004470018301		44,50

MACCHINA CAFFÈ 'KA183CB' 12-14 TAZZE 900W BOMANN

UV1	UV2	IMBALLO
1	6	1/6 PB



4 0 0 4 4 7 0 0 1 8 3 0 1



ART	BARCODE	ST.	PREZZO
02 30 04	4006160638370	H	39,50

MACCHINA CAFFÈ 'KA 3689' PINK 15 TAZZE 1000W CLATRONIC

UV1	UV2	IMBALLO
1	4	1/4 PB



4 0 0 6 1 6 0 6 3 8 3 7 0



ART	BARCODE	ST.	PREZZO
10 11 10	4006160111125		120,00

DISPENSER BEVANDE CALDE 16L HGA1111 1500W PROFICOOK

UV1	UV2	IMBALLO
1	2	1/1 PB



4 0 0 6 1 6 0 1 1 1 1 2 5



ART	BARCODE	ST.	PREZZO
02 27 53	4006508179923		2,10

2 DECALCIFICANTE BIO CITRUS CLEAN

UV1	UV2	IMBALLO
1	17	1/17 BK



4 0 0 6 5 0 8 1 7 9 9 2 3

Stirare Cura Della Persona



ART	BARCODE	ST.	PREZZO
02 59 31	4004470070200	A	7,30

RASALANA 'MC702CB' BOMANN

UV1	UV2	IMBALLO
1	20	1/20 PB



4 0 0 4 4 7 0 0 7 0 2 0 0



ART	BARCODE	ST.	PREZZO
02 30 76*	4006160630633		6,50

RASALANA 'MC 3240' CLATRONIC

UV1	UV2	IMBALLO
1	20	1/20 PB



4 0 0 6 1 6 0 6 3 0 6 3 3



ART	BARCODE	ST.	PREZZO
02 72 31	4006160308006	A	15,90

RASALANA TEXTILE CLEANER 'PC-TC 3080' PROFICARE

UV1	UV2	IMBALLO
1	10	1/10 PB



4 0 0 6 1 6 0 3 0 8 0 0 6



ART	BARCODE	ST.	PREZZO
02 30 69	4006160638912		34,50

SPAZZOLA STIRATRICE VERTICALE 'DB3717' 1100W CLATRONIC

UV1	UV2	IMBALLO
1	6	1/6 PB



4 0 0 6 1 6 0 6 3 8 9 1 2



ART	BARCODE	ST.	PREZZO
02 30 72*	4006160635317		26,50

FERRO DA STIRO DA VIAGGIO 'DB3108B' 800W CLATRONIC

UV1	UV2	IMBALLO
1	12	1/12 PB



4 0 0 6 1 6 0 6 3 5 3 1 7



ART	BARCODE	ST.	PREZZO
02 58 46*	4004470603415		89,50

FERRO DA STIRO A VAPORE CON CALDAIA 'DB6034CB' 2300W BOMANN

UV1	UV2	IMBALLO
1	2	1/2 PB



4 0 0 4 4 7 0 6 0 3 4 1 5



ART	BARCODE	ST.	PREZZO
02 58 27*	4004470600315		21,50

FERRO DA STIRO A VAPORE 'DB6003CB' 1800W BOMANN

UV1	UV2	IMBALLO
1	6	1/6 PB



4 0 0 4 4 7 0 6 0 0 3 1 5



ART	BARCODE	ST.	PREZZO
02 58 30*	4004470600414		24,50

FERRO DA STIRO A VAPORE 'DB6004CB' 2200W BOMANN

UV1	UV2	IMBALLO
1	6	1/6 PB



4 0 0 4 4 7 0 6 0 0 4 1 4



ART	BARCODE	ST.	PREZZO
02 58 31	4004470603514		26,00

FERRO DA STIRO A VAPORE 'DB 6035 CB' 2200W BOMANN

UV1	UV2	IMBALLO
1	6	1/6 PB



4 0 0 4 4 7 0 6 0 3 5 1 4



ART	BARCODE	ST.	PREZZO
02 58 43	4004470078411		29,50

FERRO DA STIRO A VAPORE 'DB784CB' 2500W BOMANN

UV1	UV2	IMBALLO
1	6	1/6 PB



4 0 0 4 4 7 0 0 7 8 4 1 1



ART	BARCODE	ST.	PREZZO
02 58 44	4004470600513		32,50

FERRO DA STIRO A VAPORE 'DB6005CB' 2600W BOMANN

UV1	UV2	IMBALLO
1	6	1/6 PB



4 0 0 4 4 7 0 6 0 0 5 1 3



ART	BARCODE	ST.	PREZZO
02 61 03	4004470096002		32,50

ASPIRASOLIDI/LIQUIDI ACCU 'AKS960CB' BOMANN

UV1	UV2	IMBALLO
1	6	1/6 PB



4 0 0 4 4 7 0 0 9 6 0 0 2



ART	BARCODE	ST.	PREZZO
02 61 04	4004470071399	A	48,50

ASPIRASOLIDI/LIQUIDI ACCU 'AKS713CB' BOMANN

UV1	UV2	IMBALLO
1	4	1/4 PB



4 0 0 4 4 7 0 0 7 1 3 9 9



ART	BARCODE	ST.	PREZZO
02 72 52	4006160303902		105,00

ASPIRAPOLVERE 'PC-BS 3039' BIANCO 700W PROFICARE

UV1	UV2	IMBALLO
1	2	1/1 PB



4 0 0 6 1 6 0 3 0 3 9 0 2



ART	BARCODE	ST.	PREZZO
02 61 16	4004470638219		97,50

ASPIRAPOLVERE 'BS 3000 CB' ROSSO 700W BOMANN

UV1	UV2	IMBALLO
1	2	1/1 PB



4 0 0 4 4 7 0 6 3 8 2 1 9



ART	BARCODE	ST.	PREZZO
02 61 10	4004470094701		39,50

ASPIRAPOLVERE A MANO MINI 'CB947' 700W BOMANN

UV1	UV2	IMBALLO
1	6	1/6 PB



4 0 0 4 4 7 0 0 9 4 7 0 1



ART	BARCODE	ST.	PREZZO
02 72 41	4006160303506	A	125,00

ASPIRAPOLVERE RICAR. 2IN1 'PC-BS 3035 A' ANTRACITE PROFICARE

UV1	UV2	IMBALLO
1	2	1/2 PB



4 0 0 6 1 6 0 3 0 3 5 0 6



ART	BARCODE	ST.	PREZZO
02 72 43	4006160303704		169,50

ASPIRAPOLVERE RICARIC. 2IN1 'PC-BS 3037 A' BIANCO PROFICARE

UV1	UV2	IMBALLO
1	2	1/1 PB



4 0 0 6 1 6 0 3 0 3 7 0 4



ART	BARCODE	ST.	PREZZO
02 72 51	4006160303803	A	82,50

ASPIRAPOLVERE 2IN1 'PC-BS 3038' ROSSO 600W PROFICARE

UV1	UV2	IMBALLO
1	2	1/6 PB



4 0 0 6 1 6 0 3 0 3 8 0 3



ART	BARCODE	ST.	PREZZO
02 71 51	4006160300000	A	7,90

SPAZZOLINO ELETTRICO SONIC 'PC-EZS 3000' PROFICARE

UV1	UV2	IMBALLO
1	10	1/10 PB



4 0 0 6 1 6 0 3 0 0 0 0 0



ART	BARCODE	ST.	PREZZO
02 71 52	4006160305401	A	7,90

SPAZZOLINO ELETTRICO 'PC-EZ 3054' PROFICARE

UV1	UV2	IMBALLO
1	6	1/6 PB



4 0 0 6 1 6 0 3 0 5 4 0 1



ART	BARCODE	ST.	PREZZO
02 71 53	4006160305500	A	23,90

SPAZZOLINO ELETTRICO RICARICABILE 'PC-EZ 3055' PROFICARE

UV1	UV2	IMBALLO
1	6	1/6 PB



4 0 0 6 1 6 0 3 0 5 5 0 0



ART	BARCODE	ST.	PREZZO
02 71 71	4006160302608	A	53,50

IRRIGATORE ORALE CORDLESS RICARIC. 'PC-MD 3026 A' PROFICARE

UV1	UV2	IMBALLO
1	6	1/6 PB



4 0 0 6 1 6 0 3 0 2 6 0 8



ART	BARCODE	ST.	PREZZO
02 71 72	4006160300505	A	61,50

IRRIGATORE ORALE 600ML 'PC-MD 3005' PROFICARE

UV1	UV2	IMBALLO
1	4	1/4 PB



4 0 0 6 1 6 0 3 0 0 5 0 5



ART	BARCODE	ST.	PREZZO
02 71 76	4006160303100		74,50

DENTAL CENTER SONIC 'PC-DC 3031'
PROFICARE

UV1	UV2	IMBALLO
1	4	1/4 PB



4 0 0 6 1 6 0 3 0 3 1 0 0



ART	BARCODE	ST.	PREZZO
02 71 54*	4006160305609	A	39,50

SPAZZOLINO ELET. RICARICABILE SONIC
'PC-EZS 3056' PROFICARE

UV1	UV2	IMBALLO
1	6	1/6 PB



4 0 0 6 1 6 0 3 0 5 6 0 9



ART	BARCODE	ST.	PREZZO
02 70 46*	4006160300307		37,50

CUFFIA ASCIUGACAPELLI 3 IN 1 'PC-HTH
3003' 400W PROFICARE

UV1	UV2	IMBALLO
1	4	1/4 PB



4 0 0 6 1 6 0 3 0 0 3 0 7



ART	BARCODE	ST.	PREZZO
02 59 42*	4004470800296		13,20

ASCIUGACAPELLI DA VIAGGIO
'HT8002CB' 1200W BOMANN

UV1	UV2	IMBALLO
1	12	1/12 PB



4 0 0 4 4 7 0 8 0 0 2 9 6



ART	BARCODE	ST.	PREZZO
02 59 44*	4004470800562		16,50

ASCIUGACAPELLI DA VIAGGIO
'HTD8005CB' 1300W BOMANN

UV1	UV2	IMBALLO
1	12	1/12 AB



4 0 0 4 4 7 0 8 0 0 5 6 2



ART	BARCODE	ST.	PREZZO
02 59 14	4004470088915		24,50

ASCIUGACAPELLI 'HDT889CB' 2000W
BOMANN

UV1	UV2	IMBALLO
1	6	1/6 PB



4 0 0 4 4 7 0 0 8 8 9 1 5



ART	BARCODE	ST.	PREZZO
02 70 01*	4006160300901		15,90

ASCIUGACAPELLI BIANCO 'PC-HT 3009'
1400W PROFICARE

UV1	UV2	IMBALLO
1	6	1/6 PB



4 0 0 6 1 6 0 3 0 0 9 0 1



ART	BARCODE	ST.	PREZZO
02 70 02*	4006160300918		15,90

ASCIUGACAPELLI MARRONE 'PC-HT
3009' 1400W PROFICARE

UV1	UV2	IMBALLO
1	6	1/6 PB



4 0 0 6 1 6 0 3 0 0 9 1 8



ART	BARCODE	ST.	PREZZO
02 70 07	4006160307306		29,50

ASCIUGACAPELLI ANTRACITE/BLU 'PC-
HT 3073' 1600W PROFICARE

UV1	UV2	IMBALLO
1	4	1/4 PB



4 0 0 6 1 6 0 3 0 7 3 0 6



ART	BARCODE	ST.	PREZZO
02 70 08	4006160307313		29,50

ASCIUGACAPELLI ANTRACITE/PINK 'PC-
HT 3073' 1600W PROFICARE

UV1	UV2	IMBALLO
1	4	1/4 PB



4 0 0 6 1 6 0 3 0 7 3 1 3



ART	BARCODE	ST.	PREZZO
02 70 09	4006160308204		32,00

ASCIUGACAPELLI ANTRACITE/BLU 'PC-
HT 3082' 1800W PROFICARE

UV1	UV2	IMBALLO
1	4	1/4 PB



4 0 0 6 1 6 0 3 0 8 2 0 4



ART	BARCODE	ST.	PREZZO
02 70 04	4006160301014	A	26,50

ASCIUGACAPELLI MARRONE 'PC-HT
3010' 2200W PROFICARE

UV1	UV2	IMBALLO
1	6	1/6 PB



4 0 0 6 1 6 0 3 0 1 0 1 4



ART	BARCODE	ST.	PREZZO
02 70 03	4006160301007		26,50

ASCIUGACAPELLI BIANCO 'PC-HT 3010'
2200W PROFICARE

UV1	UV2	IMBALLO
1	6	1/6 PB



4 0 0 6 1 6 0 3 0 1 0 0 7



ART	BARCODE	ST.	PREZZO
02 70 10	4006160304602		26,50

ASCIUGACAPELLI NERO 'PC-HT 3046'
2200W PROFICARE

UV1	UV2	IMBALLO
1	6	1/6 PB



4 0 0 6 1 6 0 3 0 4 6 0 2



ART	BARCODE	ST.	PREZZO
02 70 11	4006160304718		29,50

ASCIUGACAPELLI MARRONE 'PC-HTD
3047' 2200W PROFICARE

UV1	UV2	IMBALLO
1	4	1/4 PB



4 0 0 6 1 6 0 3 0 4 7 1 8



ART	BARCODE	ST.	PREZZO
02 70 06	4006160304503		26,50

ASCIUGACAPELLI ANTRACITE 'PC-HT
3045' 2200W PROFICARE

UV1	UV2	IMBALLO
1	6	1/6 PB



4 0 0 6 1 6 0 3 0 4 5 0 3



ART	BARCODE	ST.	PREZZO
02 70 05	4006160304510	A	26,50

ASCIUGACAPELLI LILLA 'PC-HT 3045'
2200W PROFICARE

UV1	UV2	IMBALLO
1	6	1/6 PB



4 0 0 6 1 6 0 3 0 4 5 1 0



ART	BARCODE	ST.	PREZZO
02 70 13	4006160301700		34,50

ASCIUGACAPELLI NERO 'PC-HT 3017'
2200W PROFICARE

UV1	UV2	IMBALLO
1	4	1/4 PB



4 0 0 6 1 6 0 3 0 1 7 0 0



ART	BARCODE	ST.	PREZZO
02 70 14	4006160302004	A	32,00

ASCIUGACAPELLI PERLATO 'PC-HT 3020'
2000W PROFICARE

UV1	UV2	IMBALLO
1	6	1/6 PB



4 0 0 6 1 6 0 3 0 2 0 0 4



ART	BARCODE	ST.	PREZZO
02 70 12	4006160304701		29,50

ASCIUGACAPELLI NERO 'PC-HTD 3047'
2200W PROFICARE

UV1	UV2	IMBALLO
1	4	1/4 PB



4 0 0 6 1 6 0 3 0 4 7 0 1



ART	BARCODE	ST.	PREZZO
02 70 15	4006160303308		32,00

ASCIUGACAPELLI CROMATO 'PC-HT
3033' 2000W PROFICARE

UV1	UV2	IMBALLO
1	4	1/4 PB



4 0 0 6 1 6 0 3 0 3 3 0 8



ART	BARCODE	ST.	PREZZO
02 70 20	4006160304404		29,50

ASCIUGACAPELLI DA PARETE BIANCO
'PC-HT 3044' 1800W PROFICARE

UV1	UV2	IMBALLO
1	6	1/6 PB



4 0 0 6 1 6 0 3 0 4 4 0 4



ART	BARCODE	ST.	PREZZO
02 70 31	4006160302103		18,50

SPAZZOLA LISCIANTE 'PC-GB 3021' 37W
PROFICARE

UV1	UV2	IMBALLO
1	6	1/6 PB



4 0 0 6 1 6 0 3 0 2 1 0 3



ART	BARCODE	ST.	PREZZO
02 70 33	4006160301113		18,50

SPAZZOLA ARIA CALDA MARRONE 'PC-
HAS 3011' 800W PROFICARE

UV1	UV2	IMBALLO
1	6	1/6 PB



4 0 0 6 1 6 0 3 0 1 1 1 3



ART	BARCODE	ST.	PREZZO
02 70 35	4006160307207		21,00

PIASTRA LISCIANTE CERAMICA 'PC-HC 3072' BLU 35W PROFICARE

UV1	UV2	IMBALLO
1	6	1/6 PB



4 0 0 6 1 6 0 3 0 7 2 0 7



ART	BARCODE	ST.	PREZZO
02 70 36*	4006160307214		21,00

PIASTRA LISCIANTE CERAMICA 'PC-HC 3072' PINK 35W PROFICARE

UV1	UV2	IMBALLO
1	6	1/6 PB



4 0 0 6 1 6 0 3 0 7 2 1 4



ART	BARCODE	ST.	PREZZO
02 70 37*	4006160304909		18,50

FERRO PER RICCI CONICO 'PC-HC 3049' BIANCO 25W PROFICARE

UV1	UV2	IMBALLO
1	6	1/6 PB



4 0 0 6 1 6 0 3 0 4 9 0 9



ART	BARCODE	ST.	PREZZO
02 70 45*	4006160302806	A	64,00

BIGODINI TERMICI SET 20 PEZZI 'PC-LW 3028' 350W PROFICARE

UV1	UV2	IMBALLO
1	3	1/3 PB



4 0 0 6 1 6 0 3 0 2 8 0 6



ART	BARCODE	ST.	PREZZO
02 70 71	4006160305005		10,50

TAGLIAPELI PER NASO E ORECCHIE 'PC-NE 3050' PROFICARE

UV1	UV2	IMBALLO
1	12	1/12 PB



4 0 0 6 1 6 0 3 0 5 0 0 5



ART	BARCODE	ST.	PREZZO
02 70 61	4006160305319		21,50

RASOIO ELETTRICO UOMO 'PC-HR 3053' BLU PROFICARE

UV1	UV2	IMBALLO
1	6	1/6 WB



4 0 0 6 1 6 0 3 0 5 3 1 9



ART	BARCODE	ST.	PREZZO
02 70 62	4006160305302	A	21,50

RASOIO ELETTRICO UOMO 'PC-HR 3053' ANTRACITE PROFICARE

UV1	UV2	IMBALLO
1	6	1/6 WB



4 0 0 6 1 6 0 3 0 5 3 0 2



ART	BARCODE	ST.	PREZZO
02 70 63	4006160301205	A	32,00

RASOIO ELETTRICO UOMO LCD 'PC-HR 3012' ANTRACITE PROFICARE

UV1	UV2	IMBALLO
1	6	1/6 WB



4 0 0 6 1 6 0 3 0 1 2 0 5



ART	BARCODE	ST.	PREZZO
02 70 64	4006160302301		39,50

RASOIO ELETTRICO UOMO LED 'PC-HR 3023' CROMATO PROFICARE

UV1	UV2	IMBALLO
1	4	1/4 WB



4 0 0 6 1 6 0 3 0 2 3 0 1



ART	BARCODE	ST.	PREZZO
02 70 75	4006160307405	A	20,90

TRIMMER/RIFINITORE PELI CORPO 2IN1 'PC-BHT 3074' PROFICARE

UV1	UV2	IMBALLO
1	4	1/4 WB



4 0 0 6 1 6 0 3 0 7 4 0 5



ART	BARCODE	ST.	PREZZO
02 60 02*	4004470800715		17,50

TAGLIACAPELLI + TRIMMER HSM 8007 NE CB BOMANN

UV1	UV2	IMBALLO
1	10	1/10 DC



4 0 0 4 4 7 0 8 0 0 7 1 5



ART	BARCODE	ST.	PREZZO
02 70 76	4006160301403		29,50

RASOIO E TRIMMER SET 5IN1 'PC-BHT 3014' ANTRACITE PROFICARE

UV1	UV2	IMBALLO
1	6	1/6 WB



4 0 0 6 1 6 0 3 0 1 4 0 3



ART	BARCODE	ST.	PREZZO
02 70 77	4006160301502		29,50

RASOIO E TRIMMER SET 5IN1 'PC-BHT 3015' BLU PROFICARE

UV1	UV2	IMBALLO
1	6	1/6 WB



4 0 0 6 1 6 0 3 0 1 5 0 2



ART	BARCODE	ST.	PREZZO
02 70 81	4006160301304		23,90

RASOIO BARBA E CAPELLI 'PC-HSM/R 3013' PROFICARE

UV1	UV2	IMBALLO
1	6	1/6 PB



4 0 0 6 1 6 0 3 0 1 3 0 4



ART	BARCODE	ST.	PREZZO
02 70 82	4006160305104		26,50

RASOIO PROFESSIONALE BARBA+CAPELLI 'PC-HSM/R 3051' PROFICARE

UV1	UV2	IMBALLO
1	6	1/6 PB



4 0 0 6 1 6 0 3 0 5 1 0 4



ART	BARCODE	ST.	PREZZO
02 70 83	4006160305203		29,50

RASOIO PROFI BARBA+CAPELLI+PELE 'PC-HSM/R 3052 NE' PROFICARE

UV1	UV2	IMBALLO
1	6	1/6 PB



4 0 0 6 1 6 0 3 0 5 2 0 3



ART	BARCODE	ST.	PREZZO
02 71 01	4006160300109	A	23,90

LADY BEAUTY SET RASOIO 3IN1 'PC-LBS 3001' PROFICARE

UV1	UV2	IMBALLO
1	6	1/6 PB



4 0 0 6 1 6 0 3 0 0 1 0 9



ART	BARCODE	ST.	PREZZO
02 71 02	4006160300208		26,50

LADY BEAUTY SET EPILATORE 3IN1 'PC-LBS 3002' PROFICARE

UV1	UV2	IMBALLO
1	6	1/6 PB



4 0 0 6 1 6 0 3 0 0 2 0 8



ART	BARCODE	ST.	PREZZO
02 71 15	4006160301601		13,50

SET MANICURE/PEDICURE 'PC-MPS 3016' 6 ACCESSORI PROFICARE

UV1	UV2	IMBALLO
1	10	1/10 PB



4 0 0 6 1 6 0 3 0 1 6 0 1



ART	BARCODE	ST.	PREZZO
02 71 16	4006160300406		32,00

SET MANICURE/PEDICURE 'PC-MPS 3004' 7 ACCESSORI PROFICARE

UV1	UV2	IMBALLO
1	4	1/4 PB



4 0 0 6 1 6 0 3 0 0 4 0 6



ART	BARCODE	ST.	PREZZO
02 71 91	4006160302707		62,50

IDROMASSAGGIATORE PLANTARE 'PC-FM 3027' 80W PROFICARE

UV1	UV2	IMBALLO
1	2	1/2 PB



4 0 0 6 1 6 0 3 0 2 7 0 7

Piastre Elettriche Induzione



ART	BARCODE	ST.	PREZZO
02 55 09	4004470502701		29,50

PIASTRA CUCINA SINGOLA 'EKP5027CB'
1500W BOMANN

UV1	UV2	IMBALLO
1	2	1/4 PB



4 0 0 4 4 7 0 5 0 2 7 0 1



ART	BARCODE	ST.	PREZZO
02 55 10	4004470502800		55,00

PIASTRA CUCINA DOPPIA 'DKP5028CB'
2500W BOMANN

UV1	UV2	IMBALLO
1	3	1/3 PB



4 0 0 4 4 7 0 5 0 2 8 0 0



ART	BARCODE	ST.	PREZZO
02 55 11*	4004470503319	A	59,50

PIASTRA CUCINA DOPPIA INOX 'DKP5033
E CB' 2500W BOMANN

UV1	UV2	IMBALLO
1	3	1/3 PB



4 0 0 4 4 7 0 5 0 3 3 1 9



ART	BARCODE	ST.	PREZZO
02 81 73	4006160106206		69,50

PIASTRA INDUZIONE SINGOLA 'EKI 1062'
2000W PROFICOOK

UV1	UV2	IMBALLO
1	2	1/2 PB



4 0 0 6 1 6 0 1 0 6 2 0 6



ART	BARCODE	ST.	PREZZO
02 81 74	4006160106701		155,00

PIASTRA INDUZIONE DOPPIA 'DKI 1067'
3500W PROFICOOK

UV1	UV2	IMBALLO
1	2	1/2 PB



4 0 0 6 1 6 0 1 0 6 7 0 1



ART	BARCODE	ST.	PREZZO
02 81 68*	4006160012101		59,50

PIASTRA INFRAROSSI SINGOLA 'EKP
1210' 2000W PROFICOOK

UV1	UV2	IMBALLO
1	2	1/2 PB



4 0 0 6 1 6 0 0 1 2 1 0 1



ART	BARCODE	ST.	PREZZO
02 81 69*	4006160012118		115,00

PIASTRA INFRAROSSI DOPPIA 'DKP 1211'
2800W PROFICOOK

UV1	UV2	IMBALLO
1	2	1/2 PB



4 0 0 6 1 6 0 0 1 2 1 1 8

Attrezzature Speciali



ART	BARCODE	ST.	PREZZO
02 27 37	4004369165215		21,80

**RISCALDATORE
IMMERSIONE+BICCHIERE LURAN 300W**

UV1	UV2	IMBALLO
1	10	1/100 BK



4 0 0 4 3 6 9 1 6 5 2 1 5



ART	BARCODE	ST.	PREZZO
02 27 40	4004369158217		15,90

**RISCALDATORE IMMERSIONE+FODERA
300W**

UV1	UV2	IMBALLO
1	10	1/300 BK



4 0 0 4 3 6 9 1 5 8 2 1 7



ART	BARCODE	ST.	PREZZO
02 30 97*	4006160638905		23,50

**LUNCHBOX 'LB 3719' 1.7 LITRI 40W
CLATRONIC**

UV1	UV2	IMBALLO
1	6	1/6 PB



4 0 0 6 1 6 0 6 3 8 9 0 5



ART	BARCODE	ST.	PREZZO
02 54 48*	4004470102710		219,00

**MACCHINA PER CUBETTI GHIACCIO
'EWB1027CB' 95W BOMANN**

UV1	UV2	IMBALLO
1	2	1/1 PB



4 0 0 4 4 7 0 1 0 2 7 1 0



ART	BARCODE	ST.	PREZZO
02 81 47*	4006160211870		255,00

**MACCHINA PER CUBETTI GHIACCIO 'EWB
1187' PROFICOOK**

UV1	UV2	IMBALLO
1	2	1/1 PB



4 0 0 6 1 6 0 2 1 1 8 7 0



ART	BARCODE	ST.	PREZZO
02 81 43*	4006160110913	A	365,00

**MACCHINA GELATO/JOGHURT
'ICM1091N' 150W PROFICOOK**

UV1	UV2	IMBALLO
1	2	1/1 PB



4 0 0 6 1 6 0 1 1 0 9 1 3



ART	BARCODE	ST.	PREZZO
02 80 35*	4006160116854	H	99,50

**DISPENSER ACQUA CALDA "HWS 1168"
2600W PROFICOOK**

UV1	UV2	IMBALLO
1	2	1/2 PB



4 0 0 6 1 6 0 1 1 6 8 5 4



ART	BARCODE	ST.	PREZZO
02 30 56	4006160626957		67,50

**FONTANA CIOCCOLATO
'SKB3248'ACCIAIO INOSSIDAB.170W
CLATRONIC**

UV1	UV2	IMBALLO
1	4	1/4 PB



4 0 0 6 1 6 0 6 2 6 9 5 7



ART	BARCODE	ST.	PREZZO
02 30 44*	4006160633351		29,80

**POPCORN MAKER 'PM3635' 1200W
CLATRONIC**

UV1	UV2	IMBALLO
1	6	1/6 PB



4 0 0 6 1 6 0 6 3 3 3 5 1



ART	BARCODE	ST.	PREZZO
02 30 27*	4006160638646	H	32,00

**COLTELLO ELETTRICO 'EM 3702' 120W
CLATRONIC**

UV1	UV2	IMBALLO
1	6	1/6 PB



4 0 0 6 1 6 0 6 3 8 6 4 6



ART	BARCODE	ST.	PREZZO
02 54 27	4004470045109		95,00

**AFFETTATRICE 'MA451CB' ACCIAIO
INOSSIDAB. 150W Ø19CM BOMANN**

UV1	UV2	IMBALLO
1	2	1/2 PB



4 0 0 4 4 7 0 0 4 5 1 0 9



ART	BARCODE	ST.	PREZZO
02 81 86	4006160114607		92,50

**MACCHINA SOTTOVUOTO 'VK1146' INOX
120W PROFICOOK**

UV1	UV2	IMBALLO
1	2	1/2 PB



4 0 0 6 1 6 0 1 1 4 6 0 7



ART	BARCODE	ST.	PREZZO
02 30 68	4006160631364	A	16,50

CATTURA INSETTI 'IV3340' 4W CLATRONIC

UV1	UV2	IMBALLO
1	6	1/6 PB



4 0 0 6 1 6 0 6 3 1 3 6 4



ART	BARCODE	ST.	PREZZO
02 43 79	4015067206100	A	26,50

MISURATORE PRESSIONE 'BMG5610' AEG

UV1	UV2	IMBALLO
1	6	1/6 PB



4 0 1 5 0 6 7 2 0 6 1 0 0



ART	BARCODE	ST.	PREZZO
02 71 42	4006160301908		34,50

MISURATORE PRESSIONE 'PC- BMG 3019' PROFICARE

UV1	UV2	IMBALLO
1	6	1/6 PB



4 0 0 6 1 6 0 3 0 1 9 0 8



ART	BARCODE	ST.	PREZZO
02 62 08	4004470109603	A	21,00

TERMOVENTILATORE 'HL1096CB' 2000W BOMANN

UV1	UV2	IMBALLO
1	4	1/4 PB



4 0 0 4 4 7 0 1 0 9 6 0 3



ART	BARCODE	ST.	PREZZO
02 62 07	4004470604016		24,50

TERMOVENTILATORE BIANCO 'HL6040CB' 2000W BOMANN

UV1	UV2	IMBALLO
1	4	1/4 PB



4 0 0 4 4 7 0 6 0 4 0 1 6



ART	BARCODE	ST.	PREZZO
02 72 01	4006160305906		29,50

CUSCINO RISCALDATO 'PC-HK 3059' BIANCO 100W PROFICARE

UV1	UV2	IMBALLO
1	6	1/6 PB



4 0 0 6 1 6 0 3 0 5 9 0 6



ART	BARCODE	ST.	PREZZO
02 72 02	4006160306002		37,50

SCALDA-LETTO 'PC-WUB 3060' BIANCO 60W PROFICARE

UV1	UV2	IMBALLO
1	6	1/6 PB



4 0 0 6 1 6 0 3 0 6 0 0 2



ART	BARCODE	ST.	PREZZO
02 72 03	4006160306101		79,50

COPERTA ELETTRICA 'PC-WDZ 3061' GRIGIA 180W PROFICARE

UV1	UV2	IMBALLO
1	2	1/2 PB



4 0 0 6 1 6 0 3 0 6 1 0 1



ART	BARCODE	ST.	PREZZO
02 72 11	4006160307702		89,50

UMIDIFICATORE 'PC-LB 3077' BIANCO 25W PROFICARE

UV1	UV2	IMBALLO
1	2	1/2 PB



4 0 0 6 1 6 0 3 0 7 7 0 2



ART	BARCODE	ST.	PREZZO
02 72 12	4006160307504		115,00

PURIFICATORE ARIA 'PC-LR 3075' BIANCO 25W PROFICARE

UV1	UV2	IMBALLO
1	2	1/2 PB



4 0 0 6 1 6 0 3 0 7 5 0 4

KAUFGUT[®]



Casa - Haus

Grill Barbecue



ART	BARCODE	ST.	PREZZO
01 36 53	8011126006854		8,80

**TOSTAPANE ACCIAIO INOSSIDABILE
25X25CM GNALI**

UV1	UV2	IMBALLO
1	5	1/5/50 HB



8 0 1 1 1 2 6 0 0 6 8 5 4



ART	BARCODE	ST.	PREZZO
10 01 34	8004537001341		22,60

**GRILL PIETRA NATURALE+2 BRUCIATORI
19X37CM EVA**

UV1	UV2	IMBALLO
1	3	1/3 PB



8 0 0 4 5 3 7 0 0 1 3 4 1



ART	BARCODE	ST.	PREZZO
10 01 39	8004537201451		35,50

**GRILL PIETRA NATURALE+SUPPORTO
30X40CM EVA**

UV1	UV2	IMBALLO
1	4	1/2 PB



8 0 0 4 5 3 7 2 0 1 4 5 1



ART	BARCODE	ST.	PREZZO
10 02 30	4006822112507		1,30

32 PZ ACCENDITORE CARBONELLA

UV1	UV2	IMBALLO
1	24	1/24 PB



4 0 0 6 8 2 2 1 1 2 5 0 7



ART	BARCODE	ST.	PREZZO
10 02 32	4006822112477		3,95

96 PZ ACCENDITORE CARBONELLA

UV1	UV2	IMBALLO
1	8	1/8 PB



4 0 0 6 8 2 2 1 1 2 4 7 7



ART	BARCODE	ST.	PREZZO
10 02 47	8004537000023	A	1,95

100 SPIEDINI IN BAMBOO 25CM EVA

UV1	UV2	IMBALLO
1	24	1/24/144 PH



8 0 0 4 5 3 7 0 0 0 0 2 3



ART	BARCODE	ST.	PREZZO
04 06 76	7611264509654		7,10

**3 SET DA 2 SPIEDINI PER PANNOCCHIE
'CORNER' MOHA**

UV1	UV2	IMBALLO
1	6	1/12/72 HB



7 6 1 1 2 6 4 5 0 9 6 5 4



ART	BARCODE	ST.	PREZZO
10 02 10	4004094127472		14,20

**PINZA PER SALSICCIA ACCIAIO
INOSSIDABILE 34 CM WESTMARK**

UV1	UV2	IMBALLO
1	5	1/5/50 CD



4 0 0 4 0 9 4 1 2 7 4 7 2



ART	BARCODE	ST.	PREZZO
04 20 63	8004537420630	A	2,75

**PINZA CUCINA/GRILL ACCIAIO
INOSSIDABILE 30CM EVA**

UV1	UV2	IMBALLO
1	6	1/6/120 CD



8 0 0 4 5 3 7 4 2 0 6 3 0



ART	BARCODE	ST.	PREZZO
04 20 64	8004537420647	A	3,40

**PINZA CUCINA/GRILL ACCIAIO
INOSSIDABILE 40CM EVA**

UV1	UV2	IMBALLO
1	6	1/6/120 CD



8 0 0 4 5 3 7 4 2 0 6 4 7



ART	BARCODE	ST.	PREZZO
04 20 77	4004094151279		8,45

**PINZA CUCINA 'COMFORT' PA/ACCIAIO
INOSSIDABILE WESTMARK**

UV1	UV2	IMBALLO
1	5	1/5/50 CD



4 0 0 4 0 9 4 1 5 1 2 7 9



ART	BARCODE	ST.	PREZZO
10 02 27*	8004537002270	H	4,60

PENNELLO PER GRILL 46CM EVA

UV1	UV2	IMBALLO
1	6	1/12/48 HT



8 0 0 4 5 3 7 0 0 2 2 7 0



ART	BARCODE	ST.	PREZZO
10 03 26	4004094150586		13,50

PINZA GRILL ACCIAIO INOSSIDABILE / PP 40CM WESTMARK

UV1	UV2	IMBALLO
1	3	1/3/24 DC



4 0 0 4 0 9 4 1 5 0 5 8 6



ART	BARCODE	ST.	PREZZO
10 03 27	4004094150685		10,60

PENNELLO GRILL ACCIAIO INOSSIDABILE / PP 38CM WESTMARK

UV1	UV2	IMBALLO
1	3	1/3/24 DC



4 0 0 4 0 9 4 1 5 0 6 8 5



ART	BARCODE	ST.	PREZZO
10 03 28	4004094150784		12,60

SPAZZOLA GRILL ACCIAIO INOSSIDABILE / PP 38CM WESTMARK

UV1	UV2	IMBALLO
1	3	1/3/24 DC



4 0 0 4 0 9 4 1 5 0 7 8 4



ART	BARCODE	ST.	PREZZO
10 03 29	4004094150883		8,70

FORCHETTONE GRILL ACCIAIO INOSSIDABILE / PP 40CM WESTMARK

UV1	UV2	IMBALLO
1	3	1/3/24 DC



4 0 0 4 0 9 4 1 5 0 8 8 3



ART	BARCODE	ST.	PREZZO
10 03 30	4004094150982		12,25

PALETTA GRILL ACCIAIO INOSSIDABILE / PP 42CM WESTMARK

UV1	UV2	IMBALLO
1	3	1/3/24 DC



4 0 0 4 0 9 4 1 5 0 9 8 2



ART	BARCODE	ST.	PREZZO
10 02 22	8004537200034		6,20

SPAZZOLA GRILL EVA

UV1	UV2	IMBALLO
1	6	1/12/72 HT



8 0 0 4 5 3 7 2 0 0 0 3 4



ART	BARCODE	ST.	PREZZO
10 03 31	4004094156571	A	16,90

GREMBIULE GRILL/CUCINA COTONE WESTMARK

UV1	UV2	IMBALLO
1	3	1/3/24 PH



4 0 0 4 0 9 4 1 5 6 5 7 1

Campeggio Trekking



ART	BARCODE	ST.	PREZZO
07 12 21*	8004537712216	H	5,95

FIASCHETTA TASCABILE ACCIAIO
INOSSIDABILE/PVC NERO 0,25L EVA

UV1	UV2	IMBALLO
1	10	1/10/100 PB



8 0 0 4 5 3 7 7 1 2 2 1 6



ART	BARCODE	ST.	PREZZO
07 12 20	8004537712209	A	4,95

FIASCHETTA TASCABILE ACCIAIO
INOSSIDABILE 0,25L EVA

UV1	UV2	IMBALLO
1	10	1/10/100 PB



8 0 0 4 5 3 7 7 1 2 2 0 9



ART	BARCODE	ST.	PREZZO
10 17 45	7610859172235	A	6,90

BOTTIGLIA SPORT 0,6 LITRI ROTHO

UV1	UV2	IMBALLO
1	10	1/10 SL



7 6 1 0 8 5 9 1 7 2 2 3 5



ART	BARCODE	ST.	PREZZO
10 17 46	7610859172242	A	8,40

BOTTIGLIA SPORT 0,8 LITRI ROTHO

UV1	UV2	IMBALLO
1	10	1/10 SL



7 6 1 0 8 5 9 1 7 2 2 4 2



ART	BARCODE	ST.	PREZZO
10 17 47	7610859172259	A	9,75

BOTTIGLIA SPORT 1,0 LITRI ROTHO

UV1	UV2	IMBALLO
1	10	1/10 SL



7 6 1 0 8 5 9 1 7 2 2 5 9



ART	BARCODE	ST.	PREZZO
10 17 65	8004537017656		3,70

BORRACCIA BAMBINI ALLUMINIO
ASSORTITA 400ML IN DISPLAY EVA

UV1	UV2	IMBALLO
12	24	1/12/48 DB



8 0 0 4 5 3 7 0 1 7 6 5 6



ART	BARCODE	ST.	PREZZO
10 17 66	8004537017663		5,80

BORRACCIA MONTAGNA ALLUMINIO
COLORI ASSORT.1L IN DISPLAY EVA

UV1	UV2	IMBALLO
12	24	12/12/48 DB



8 0 0 4 5 3 7 0 1 7 6 6 3



ART	BARCODE	ST.	PREZZO
09 04 01	8004537904017		7,00

BOTTIGLIA IN VETRO CON FODERA
FELTRO GRIGIO 0,5L EVA

UV1	UV2	IMBALLO
1	6	1/24 PB



8 0 0 4 5 3 7 9 0 4 0 1 7



ART	BARCODE	ST.	PREZZO
09 04 03	8004537904031		6,50

BOTTIGLIA IN VETRO CON FODERA
JEANS 0,5L EVA

UV1	UV2	IMBALLO
1	6	1/24 PB



8 0 0 4 5 3 7 9 0 4 0 3 1



ART	BARCODE	ST.	PREZZO
09 04 02	8004537904024		7,00

BOTTIGLIA VETRO CON FODERA FELTRO
ANTRACITE 0,5L EVA

UV1	UV2	IMBALLO
1	6	1/24 PB



8 0 0 4 5 3 7 9 0 4 0 2 4



ART	BARCODE	ST.	PREZZO
09 04 11	8004537904116		7,50

BOTTIGLIA IN VETRO+FODERA FELTRO
ANTRACITE/ROSSO 0,75L EVA

UV1	UV2	IMBALLO
1	6	1/24 PB



8 0 0 4 5 3 7 9 0 4 1 1 6



ART	BARCODE	ST.	PREZZO
09 04 12	8004537904123		7,50

BOTTIGLIA IN VETRO+FODERA FELTRO
ANTRACITE/VERDE 0,75L EVA

UV1	UV2	IMBALLO
1	6	1/24 PB



8 0 0 4 5 3 7 9 0 4 1 2 3



ART	BARCODE	ST.	PREZZO
09 04 13	8004537904130		7,50

BOTTIGLIA IN VETRO+FODERA FELTRO ANTRACITE/GIALLO 0,75L EVA

UV1	UV2	IMBALLO
1	6	1/24 PB



8 0 0 4 5 3 7 9 0 4 1 3 0



ART	BARCODE	ST.	PREZZO
09 04 21	8004537904215		8,00

BOTTIGLIA IN VETRO+FODERA FELTRO ANTRACITE/ROSSO 1,00L EVA

UV1	UV2	IMBALLO
1	6	1/24 PB



8 0 0 4 5 3 7 9 0 4 2 1 5



ART	BARCODE	ST.	PREZZO
09 04 22	8004537904222		8,00

BOTTIGLIA IN VETRO+FODERA FELTRO ANTRACITE/VERDE 1,00L EVA

UV1	UV2	IMBALLO
1	6	1/24 PB



8 0 0 4 5 3 7 9 0 4 2 2 2



ART	BARCODE	ST.	PREZZO
09 04 23	8004537904239		8,00

BOTTIGLIA IN VETRO+FODERA FELTRO ANTRACITE/GIALLO 1,00L EVA

UV1	UV2	IMBALLO
1	6	1/24 PB



8 0 0 4 5 3 7 9 0 4 2 3 9



ART	BARCODE	ST.	PREZZO
04 19 11	4009808252013	A	2,50

KLICKBOX PORTAPANINO ASSORTITO Ø12 X 8 CM BUCHSTEINER

UV1	UV2	IMBALLO
1	5	1/25 BK



4 0 0 9 8 0 8 2 5 2 0 1 3



ART	BARCODE	ST.	PREZZO
04 19 13	4009808291616		2,50

KLICKBOX ALTO ASSORTITO 18X13X6 CM BUCHSTEINER

UV1	UV2	IMBALLO
1	12	1/12 BK



4 0 0 9 8 0 8 2 9 1 6 1 6



ART	BARCODE	ST.	PREZZO
04 19 19	4009808255519		6,90

KLICKBOX B-BOX BANANA GIALLO 21CM BUCHSTEINER

UV1	UV2	IMBALLO
1	8	1/44 AL



4 0 0 9 8 0 8 2 5 5 5 1 9



ART	BARCODE	ST.	PREZZO
04 19 36	4009808432613		2,30

KLICKBOX ALTO ASSORTITO IN DISPLAY BUCHSTEINER

UV1	UV2	IMBALLO
32	64	1/32 DB



4 0 0 9 8 0 8 4 3 2 6 1 3



ART	BARCODE	ST.	PREZZO
04 19 38	4009808432415		2,30

KLICKBOX ROTONDO ASSORTITO 12CM IN DISPLAY BUCHSTEINER

UV1	UV2	IMBALLO
25	50	1/25 DB



4 0 0 9 8 0 8 4 3 2 4 1 5



ART	BARCODE	ST.	PREZZO
04 19 06	4004094210495		2,85

TAZZA CON MANICO COLORI ASSORTITI PP 0,3 L WESTMARK

UV1	UV2	IMBALLO
1	5	1/5/100 BK



4 0 0 4 0 9 4 2 1 0 4 9 5



ART	BARCODE	ST.	PREZZO
04 19 04	8002953002928		1,90

BOCCALE MINI PP DECORATO 0,25L

UV1	UV2	IMBALLO
1	12	1/12/72 BK



8 0 0 2 9 5 3 0 0 2 9 2 8



ART	BARCODE	ST.	PREZZO
04 19 02	4004094511813	A	4,05

BICCHIERE TELESCOPICO PS 0,125L IN DISPLAY WESTMARK

UV1	UV2	IMBALLO
24	48	1/24/432 DB



4 0 0 4 0 9 4 5 1 1 8 1 3



ART	BARCODE	ST.	PREZZO
04 15 82	7610859151827	A	2,00

MUG "CARUBA LIME" VERDE PP 0.25L ROTHO

UV1	UV2	IMBALLO
1	6	1/6 BK



7 6 1 0 8 5 9 1 5 1 8 2 7



ART	BARCODE	ST.	PREZZO
04 15 84	7610859151858		1,10

BICCHIERE "CARUBA LIME" VERDE PP 0.25L ROTHO

UV1	UV2	IMBALLO
1	6	1/6 BK



7 6 1 0 8 5 9 1 5 1 8 5 8



ART	BARCODE	ST.	PREZZO
04 15 85	7610859152008		5,50

BROCCA+COPERCHIO "CARUBA LIME" VERDE PP 1.20L ROTHO

UV1	UV2	IMBALLO
1	6	1/6 BK



7 6 1 0 8 5 9 1 5 2 0 0 8



ART	BARCODE	ST.	PREZZO
04 15 87	7610859151889		2,25

CIOTOLA "CARUBA LIME" VERDE PP Ø12.5CM ROTHO

UV1	UV2	IMBALLO
1	6	1/6 BK



7 6 1 0 8 5 9 1 5 1 8 8 9



ART	BARCODE	ST.	PREZZO
04 15 88	7610859151919		4,40

CIOTOLA "CARUBA LIME" VERDE PP Ø22.5CM ROTHO

UV1	UV2	IMBALLO
1	4	1/4 BK



7 6 1 0 8 5 9 1 5 1 9 1 9



ART	BARCODE	ST.	PREZZO
04 15 89	7610859152305		8,50

CIOTOLA "CARUBA LIME" VERDE PP Ø34CM ROTHO

UV1	UV2	IMBALLO
1	4	1/4 BK



7 6 1 0 8 5 9 1 5 2 3 0 5



ART	BARCODE	ST.	PREZZO
04 15 91	7610859202956		6,20

CIOTOLA CON COPERCHIO 'CARUBA LIME' PP 1.8L - Ø 23CM ROTHO

UV1	UV2	IMBALLO
1	3	1/3 AL



7 6 1 0 8 5 9 2 0 2 9 5 6



ART	BARCODE	ST.	PREZZO
04 15 92	7610859202963		10,50

CIOTOLA CON COPERCHIO 'CARUBA LIME' PP 4.8L - Ø 30CM ROTHO

UV1	UV2	IMBALLO
1	2	1/2 AL



7 6 1 0 8 5 9 2 0 2 9 6 3



ART	BARCODE	ST.	PREZZO
04 15 65	7610859151834	A	2,00

MUG "CARUBA AQUA" BLU PP 0.25L ROTHO

UV1	UV2	IMBALLO
1	6	1/6 BK



7 6 1 0 8 5 9 1 5 1 8 3 4



ART	BARCODE	ST.	PREZZO
04 15 66	7610859151865		1,10

BICCHIERE "CARUBA AQUA" BLU PP 0.25L ROTHO

UV1	UV2	IMBALLO
1	6	1/6 BK



7 6 1 0 8 5 9 1 5 1 8 6 5



ART	BARCODE	ST.	PREZZO
04 15 72	7610859152312	A	8,25

CIOTOLA "CARUBA AQUA" BLU PP Ø34CM ROTHO

UV1	UV2	IMBALLO
1	4	1/4 BK



7 6 1 0 8 5 9 1 5 2 3 1 2



ART	BARCODE	ST.	PREZZO
04 15 75	7610859151810	A	2,00

MUG "CARUBA PAPAYA" ROSSO PP 0.25L ROTHO

UV1	UV2	IMBALLO
1	6	1/6 BK



7 6 1 0 8 5 9 1 5 1 8 1 0



ART	BARCODE	ST.	PREZZO
10 18 16	8006772929947		8,25

BUSTINA TERMICA ASSORTITA IN DISPLAY FA.BO.SS

UV1	UV2	IMBALLO
1	24	1/24 PG



8 0 0 6 7 7 2 9 2 9 9 4 7



ART	BARCODE	ST.	PREZZO
04 15 76	7610859151841		1,10

BICCHIERE "CARUBA PAPAYA" ROSSO PP 0.25L ROTHO

UV1	UV2	IMBALLO
1	6	1/6 BK



7 6 1 0 8 5 9 1 5 1 8 4 1



ART	BARCODE	ST.	PREZZO
04 15 78	7610859151872	A	2,15

CIOTOLA "CARUBA PAPAYA" ROSSO PP Ø12.5CM ROTHO

UV1	UV2	IMBALLO
1	6	1/6 BK



7 6 1 0 8 5 9 1 5 1 8 7 2



ART	BARCODE	ST.	PREZZO
04 15 80	7610859152299	A	8,25

CIOTOLA "CARUBA PAPAYA" ROSSO PP Ø34CM ROTHO

UV1	UV2	IMBALLO
1	4	1/4 BK



7 6 1 0 8 5 9 1 5 2 2 9 9



ART	BARCODE	ST.	PREZZO
10 18 65	8006772936105		12,75

BORRACCIA TERMICA 'ICEBERG' AZZURRO 1L FA.BO.SS

UV1	UV2	IMBALLO
1	6	1/12 BK



8 0 0 6 7 7 2 9 3 6 1 0 5



ART	BARCODE	ST.	PREZZO
10 18 01	8006772950019		1,60

2 ELEMENTI REFRIGERANTI AZZURRI 500G FA.BO.SS

UV1	UV2	IMBALLO
1	10	1/10 SP



8 0 0 6 7 7 2 9 5 0 0 1 9



ART	BARCODE	ST.	PREZZO
02 30 98	4006160638882	A	66,50

BORSA FRIGO 'KT 3720' 15 LITRI 50W-12V CLATRONIC

UV1	UV2	IMBALLO
1	3	1/3 PB



4 0 0 6 1 6 0 6 3 8 8 8 2



ART	BARCODE	ST.	PREZZO
10 18 04	8006772932039		59,50

FRIGO ELETTROBOX 'PLAYA' 30L 12V FA.BO.SS

UV1	UV2	IMBALLO
1	2	1/1 SP



8 0 0 6 7 7 2 9 3 2 0 3 9



ART	BARCODE	ST.	PREZZO
10 18 07	8006772935023		16,20

FRIGO BOX 'PLUS' BLU COPERCHIO A VASSOIO 28L FA.BO.SS

UV1	UV2	IMBALLO
1	2	1/1 SP



8 0 0 6 7 7 2 9 3 5 0 2 3



ART	BARCODE	ST.	PREZZO
10 18 60	8006772936051	A	26,50

FRIGO BOX 'ICEBERG' AZZURRO 32L FA.BO.SS

UV1	UV2	IMBALLO
1	2	1/2 BK



8 0 0 6 7 7 2 9 3 6 0 5 1



ART	BARCODE	ST.	PREZZO
10 18 62	8006772936075	A	67,50

FRIGO BOX 'ICEBERG' AZZURRO 52L FA.BO.SS

UV1	UV2	IMBALLO
1	2	1/1 BK



8 0 0 6 7 7 2 9 3 6 0 7 5



ART	BARCODE	ST.	PREZZO
10 18 64	8006772936099		25,50

DISPENSER TERMICO 'ICEBERG' AZZURRO 8L FA.BO.SS

UV1	UV2	IMBALLO
1	6	1/6 BK



8 0 0 6 7 7 2 9 3 6 0 9 9



ART	BARCODE	ST.	PREZZO
10 18 63	8006772936082		17,30

DISPENSER TERMICO 'ICEBERG'
AZZURRO 4,5L FA.BO.SS

UV1	UV2	IMBALLO
1	6	1/6 BK



8 0 0 6 7 7 2 9 3 6 0 8 2



ART	BARCODE	ST.	PREZZO
10 18 15	8006772921019		7,65

2 BORSE TERMICHE 'ICEPACK' 24L+7L
FA.BO.SS

UV1	UV2	IMBALLO
1	36	1/36 PH



8 0 0 6 7 7 2 9 2 1 0 1 9



ART	BARCODE	ST.	PREZZO
10 18 50	8006772911041		6,40

BORSA TERMICA ASSORTITA 'VANITY' 8L
FA.BO.SS

UV1	UV2	IMBALLO
1	12	1/12 PH



8 0 0 6 7 7 2 9 1 1 0 4 1



ART	BARCODE	ST.	PREZZO
10 18 51	8006772911058		9,15

BORSA TERMICA ASSORTITO 'VANITY'
16L FA.BO.SS

UV1	UV2	IMBALLO
1	12	1/12 PH



8 0 0 6 7 7 2 9 1 1 0 5 8



ART	BARCODE	ST.	PREZZO
10 18 52	8006772911065		12,40

BORSA TERMICA ASSORTITA 'VANITY'
24L FA.BO.SS

UV1	UV2	IMBALLO
1	6	1/12 PH



8 0 0 6 7 7 2 9 1 1 0 6 5



ART	BARCODE	ST.	PREZZO
10 18 27*	8006772900397	H	17,90

BORSA TERMICA 'POLARICE YACHT
CLUB' ASSORTITA 24L FA.BO.SS

UV1	UV2	IMBALLO
1	6	1/12 PH



8 0 0 6 7 7 2 9 0 0 3 9 7



ART	BARCODE	ST.	PREZZO
10 18 12	8006772901530		4,30

PORTA BOTTIGLIA TERMICO '2BOTTLES'
0,5L FA.BO.SS

UV1	UV2	IMBALLO
1	12	1/12 PH



8 0 0 6 7 7 2 9 0 1 5 3 0



ART	BARCODE	ST.	PREZZO
10 18 13	8006772901547		5,50

PORTA BOTTIGLIA TERMICO '2BOTTLES'
2,0L FA.BO.SS

UV1	UV2	IMBALLO
1	12	1/12 PH



8 0 0 6 7 7 2 9 0 1 5 4 7



ART	BARCODE	ST.	PREZZO
10 18 70	8006772901042	A	10,70

BORSA TERMICA 'POLAR' ASSORTITA 7L
FA.BO.SS

UV1	UV2	IMBALLO
1	6	1/12 PH



8 0 0 6 7 7 2 9 0 1 0 4 2



ART	BARCODE	ST.	PREZZO
10 18 71	8006772901035	A	13,60

BORSA TERMICA 'POLAR' ASSORTITA
13L FA.BO.SS

UV1	UV2	IMBALLO
1	6	1/12 PH



8 0 0 6 7 7 2 9 0 1 0 3 5



ART	BARCODE	ST.	PREZZO
10 18 72	8006772901134	A	19,40

BORSA TERMICA 'POLAR' ASSORTITA
20L FA.BO.SS

UV1	UV2	IMBALLO
1	6	1/12 PH



8 0 0 6 7 7 2 9 0 1 1 3 4



ART	BARCODE	ST.	PREZZO
10 18 73	8006772901141	A	23,70

BORSA TERMICA 'POLAR' ASSORTITA
30L FA.BO.SS

UV1	UV2	IMBALLO
1	6	1/12 PH



8 0 0 6 7 7 2 9 0 1 1 4 1



ART	BARCODE	ST.	PREZZO
10 18 74	8006772901158	A	29,90

ZAINO TERMICO+PORTABOTTIGLIA
'POLAR' ASSORT 26+1,5L FA.BO.SS

UV1	UV2	IMBALLO
1	6	1/12 PH



8 0 0 6 7 7 2 9 0 1 1 5 8



ART	BARCODE	ST.	PREZZO
10 18 19	8006772905170	A	5,30

BORSA TERMICA PER SURGELATI 25L
FA.BO.SS

UV1	UV2	IMBALLO
1	12	1/24 PH



8 0 0 6 7 7 2 9 0 5 1 7 0



ART	BARCODE	ST.	PREZZO
10 18 67	8006772914301	A	9,80

BORSA TERMICA 'MALIBU' ASSORTITA
8L FA.BO.SS

UV1	UV2	IMBALLO
1	12	1/12 PH



8 0 0 6 7 7 2 9 1 4 3 0 1



ART	BARCODE	ST.	PREZZO
10 18 68	8006772914318	A	12,10

BORSA TERMICA 'MALIBU' ASSORTITA
13L FA.BO.SS

UV1	UV2	IMBALLO
1	12	1/12 PH



8 0 0 6 7 7 2 9 1 4 3 1 8



ART	BARCODE	ST.	PREZZO
10 18 69	8006772914325	A	14,60

BORSA TERMICA ALLARGABILE
'MALIBU' ASSORTITA 20L FA.BO.SS

UV1	UV2	IMBALLO
1	6	1/12 PH



8 0 0 6 7 7 2 9 1 4 3 2 5



ART	BARCODE	ST.	PREZZO
10 18 76	8006772914509	A	5,10

PORTA BOTTIGLIA TERMICO 'CACTUS'
2,0L FA.BO.SS

UV1	UV2	IMBALLO
1	12	1/12 PH



8 0 0 6 7 7 2 9 1 4 5 0 9



ART	BARCODE	ST.	PREZZO
10 18 77	8006772914516	A	12,70

BORSA TERMICA 'CACTUS' 13L FA.BO.SS

UV1	UV2	IMBALLO
1	12	1/12 PH



8 0 0 6 7 7 2 9 1 4 5 1 6



ART	BARCODE	ST.	PREZZO
10 18 78	8006772914523	A	14,00

BORSA TERMICA 'CACTUS' 17L FA.BO.SS

UV1	UV2	IMBALLO
1	12	1/12 PH



8 0 0 6 7 7 2 9 1 4 5 2 3



ART	BARCODE	ST.	PREZZO
10 18 79	8006772914530	A	19,20

BORSA TERMICA 'CACTUS' 34L FA.BO.SS

UV1	UV2	IMBALLO
1	6	1/12 PH



8 0 0 6 7 7 2 9 1 4 5 3 0



ART	BARCODE	ST.	PREZZO
10 18 53	8006772911072	A	10,90

ZAINO TERMICO ASSORTITA 'VANITY' 12L
FA.BO.SS

UV1	UV2	IMBALLO
1	6	1/12 PH



8 0 0 6 7 7 2 9 1 1 0 7 2



ART	BARCODE	ST.	PREZZO
10 18 85	8006772916138	H	8,75

BORSA TERMICA 'JEANS' 8L FA.BO.SS

UV1	UV2	IMBALLO
1	6	1/12 PH



8 0 0 6 7 7 2 9 1 6 1 3 8



ART	BARCODE	ST.	PREZZO
10 18 91	8006772910365	A	9,80

BORSA TERMICA 'HELLO SUMMER'
ASSORTITA 8L FA.BO.SS

UV1	UV2	IMBALLO
1	12	1/12 PH



8 0 0 6 7 7 2 9 1 0 3 6 5



ART	BARCODE	ST.	PREZZO
10 18 92	8006772910372	A	12,10

BORSA TERMICA 'HELLO SUMMER' ASSORTITA 16L FA.BO.SS

UV1	UV2	IMBALLO
1	12	1/12 PH



8 0 0 6 7 7 2 9 1 0 3 7 2



ART	BARCODE	ST.	PREZZO
07 22 97	4000270199745	A	32,50

CESTA SHOPPING VIMINI CON MANICI 43X31X22 CM KESPER

UV1	UV2	IMBALLO
1	10	1/10 HT



4 0 0 0 2 7 0 1 9 9 7 4 5



ART	BARCODE	ST.	PREZZO
05 06 11	4019889140123		7,05

COLTELLO TASCABILE PICKNICK LAMA CERAMICA LURCH

UV1	UV2	IMBALLO
1	12	1/48 BK



4 0 1 9 8 8 9 1 4 0 1 2 3



ART	BARCODE	ST.	PREZZO
04 64 05	7610859185815		5,90

BORRACCIA MEMORY KIDS 'INSPIRE' 0.4 LITRI ROTHO

UV1	UV2	IMBALLO
1	6	1/6 AL



7 6 1 0 8 5 9 1 8 5 8 1 5



ART	BARCODE	ST.	PREZZO
04 64 06	7610859186201		5,90

BORRACCIA MEMORY KIDS 'JUNGLE' 0.4 LITRI ROTHO

UV1	UV2	IMBALLO
1	6	1/6 AL



7 6 1 0 8 5 9 1 8 6 2 0 1



ART	BARCODE	ST.	PREZZO
04 64 07	7610859186188		5,90

BORRACCIA MEMORY KIDS 'PRINCESS' 0.4 LITRI ROTHO

UV1	UV2	IMBALLO
1	6	1/6 AL



7 6 1 0 8 5 9 1 8 6 1 8 8



ART	BARCODE	ST.	PREZZO
04 64 08	7610859186195		5,90

BORRACCIA MEMORY KIDS 'FOOTBALL' 0.4 LITRI ROTHO

UV1	UV2	IMBALLO
1	6	1/6 AL



7 6 1 0 8 5 9 1 8 6 1 9 5



ART	BARCODE	ST.	PREZZO
04 64 01	7610859185822		5,60

SNACKBOX MEMORY KIDS 'INSPIRE' 1.0 LITRI ROTHO

UV1	UV2	IMBALLO
1	4	1/4 AL



7 6 1 0 8 5 9 1 8 5 8 2 2



ART	BARCODE	ST.	PREZZO
04 64 03	7610859186225		5,60

SNACKBOX MEMORY KIDS 'PRINCESS' 1.0 LITRI ROTHO

UV1	UV2	IMBALLO
1	4	1/4 AL



7 6 1 0 8 5 9 1 8 6 2 2 5



ART	BARCODE	ST.	PREZZO
04 64 04	7610859186232		5,60

SNACKBOX MEMORY KIDS 'FOOTBALL' 1.0 LITRI ROTHO

UV1	UV2	IMBALLO
1	4	1/4 AL



7 6 1 0 8 5 9 1 8 6 2 3 2



ART	BARCODE	ST.	PREZZO
04 64 02	7610859186249		5,60

SNACKBOX MEMORY KIDS 'JUNGLE' 1.0 LITRI ROTHO

UV1	UV2	IMBALLO
1	4	1/4 AL



7 6 1 0 8 5 9 1 8 6 2 4 9



ART	BARCODE	ST.	PREZZO
04 19 31	4000270413827	A	6,50

LUNCHBOX FIBRA DI BAMBU' DEC. 'MARITIM' 18.5X6X12.5CM KESPER

UV1	UV2	IMBALLO
1	3	1/3/18 SL



4 0 0 0 2 7 0 4 1 3 8 2 7



ART	BARCODE	ST.	PREZZO
10 17 01	8004537017014		13,20

LUNCHBOX ALLUMINIO ANODIZZATO SILVER 18X12X5 CM EVA

UV1	UV2	IMBALLO
1	6	1/24 PB



8 0 0 4 5 3 7 0 1 7 0 1 4



ART	BARCODE	ST.	PREZZO
10 17 11	8004537017113		16,70

LUNCHBOX ALLUMINIO ANODIZZATO SILVER 23X15X7 CM EVA

UV1	UV2	IMBALLO
1	6	1/24 PB



8 0 0 4 5 3 7 0 1 7 1 1 3



ART	BARCODE	ST.	PREZZO
10 17 02	8004537017021		14,50

LUNCHBOX ALLUMINIO ANODIZZATO ROSSO 18X12X5 CM EVA

UV1	UV2	IMBALLO
1	6	1/24 PB



8 0 0 4 5 3 7 0 1 7 0 2 1



ART	BARCODE	ST.	PREZZO
10 17 12	8004537017120		18,70

LUNCHBOX ALLUMINIO ANODIZZATO ROSSO 23X15X7 CM EVA

UV1	UV2	IMBALLO
1	6	1/24 PB



8 0 0 4 5 3 7 0 1 7 1 2 0



ART	BARCODE	ST.	PREZZO
10 17 03	8004537017038		14,50

LUNCHBOX ALLUMINIO ANODIZZATO BLU 18X12X5 CM EVA

UV1	UV2	IMBALLO
1	6	1/24 PB



8 0 0 4 5 3 7 0 1 7 0 3 8



ART	BARCODE	ST.	PREZZO
10 17 13	8004537017137		18,70

LUNCHBOX ALLUMINIO ANODIZZATO BLU 23X15X7 CM EVA

UV1	UV2	IMBALLO
1	6	1/24 PB



8 0 0 4 5 3 7 0 1 7 1 3 7



ART	BARCODE	ST.	PREZZO
10 17 04	8004537017045		14,50

LUNCHBOX ALLUMINIO ANODIZZATO ANTRACITE 18X12X5 CM EVA

UV1	UV2	IMBALLO
1	6	1/24 PB



8 0 0 4 5 3 7 0 1 7 0 4 5



ART	BARCODE	ST.	PREZZO
10 17 14	8004537017144		18,70

LUNCHBOX ALLUMINIO ANODIZZATO ANTRACITE 23X15X7 CM EVA

UV1	UV2	IMBALLO
1	6	1/24 PB



8 0 0 4 5 3 7 0 1 7 1 4 4



ART	BARCODE	ST.	PREZZO
04 19 32	4000270326813		5,70

LUNCHBOX MF DARKWOOD 18X12.5X6 CM KESPER

UV1	UV2	IMBALLO
1	3	1/3/18 AL



4 0 0 0 2 7 0 3 2 6 8 1 3

Giardino



ART	BARCODE	ST.	PREZZO
07 16 40*	4000150460170	H	3,20

COPRIVASO "ORCHIDEA" PP LILA Ø13CM GELI

UV1	UV2	IMBALLO
1	10	1/10/120 BK



4 0 0 0 1 5 0 4 6 0 1 7 0



ART	BARCODE	ST.	PREZZO
07 16 41*	4000150460002	H	3,75

COPRIVASO "ORCHIDEA" PP LILA Ø15CM GELI

UV1	UV2	IMBALLO
1	5	1/5/50 BK



4 0 0 0 1 5 0 4 6 0 0 0 2



ART	BARCODE	ST.	PREZZO
10 07 71*	4000150735223		4,40

SPRUZZATORE CON BECCUCCIO METALLICO GIALLO 0,5L GELI

UV1	UV2	IMBALLO
1	10	1/10 BK



4 0 0 0 1 5 0 7 3 5 2 2 3



ART	BARCODE	ST.	PREZZO
10 07 72*	4000150731225		5,45

SPRUZZATORE CON BECCUCCIO METALLICO GIALLO 1,0L GELI

UV1	UV2	IMBALLO
1	10	1/10 BK



4 0 0 0 1 5 0 7 3 1 2 2 5



ART	BARCODE	ST.	PREZZO
10 07 73*	4000150735049		4,40

SPRUZZATORE CON BECCUCCIO METALLICO ROSSO 0,5L GELI

UV1	UV2	IMBALLO
1	10	1/10 BK



4 0 0 0 1 5 0 7 3 5 0 4 9



ART	BARCODE	ST.	PREZZO
10 07 74*	4000150731041		5,45

SPRUZZATORE CON BECCUCCIO METALLICO ROSSO 1,0L GELI

UV1	UV2	IMBALLO
1	10	1/10 BK



4 0 0 0 1 5 0 7 3 1 0 4 1



ART	BARCODE	ST.	PREZZO
10 07 75*	4000150735100		4,40

SPRUZZATORE CON BECCUCCIO METALLICO BIANCO 0,5L GELI

UV1	UV2	IMBALLO
1	10	1/10 BK



4 0 0 0 1 5 0 7 3 5 1 0 0



ART	BARCODE	ST.	PREZZO
10 07 76*	4000150731102		5,45

SPRUZZATORE CON BECCUCCIO METALLICO BIANCO 1,0L GELI

UV1	UV2	IMBALLO
1	10	1/10 BK



4 0 0 0 1 5 0 7 3 1 1 0 2



ART	BARCODE	ST.	PREZZO
10 07 77*	4000150735247		4,40

SPRUZZATORE CON BECCUCCIO METALLICO BLU 0,5L GELI

UV1	UV2	IMBALLO
1	10	1/10 BK



4 0 0 0 1 5 0 7 3 5 2 4 7



ART	BARCODE	ST.	PREZZO
10 07 78*	4000150731249		5,45

SPRUZZATORE CON BECCUCCIO METALLICO BLU 1,0L GELI

UV1	UV2	IMBALLO
1	10	1/10 BK



4 0 0 0 1 5 0 7 3 1 2 4 9



ART	BARCODE	ST.	PREZZO
10 04 45*	4000150720052		6,25

INNAFFIATOIO "MEDUSA" PE BIANCO CREMA 1,8L GELI

UV1	UV2	IMBALLO
1	6	1/6 BK



4 0 0 0 1 5 0 7 2 0 0 5 2



ART	BARCODE	ST.	PREZZO
10 04 46*	4000150012348		6,25

INNAFFIATOIO "MEDUSA" PE ANTRACITE 1,8L GELI

UV1	UV2	IMBALLO
1	6	1/6 BK



4 0 0 0 1 5 0 0 1 2 3 4 8



ART	BARCODE	ST.	PREZZO
10 04 01	4000150742023		6,25

INNAFFIATOIO "EDEN" PE GIALLO 2L GELI

UV1	UV2	IMBALLO
1	10	1/5 BK



4 0 0 0 1 5 0 7 4 2 0 2 3



ART	BARCODE	ST.	PREZZO
10 04 02	4000150742313		6,25

INNAFFIATOIO "EDEN" PE VERDE MENTA 2L GELI

UV1	UV2	IMBALLO
1	10	1/5 BK



4 0 0 0 1 5 0 7 4 2 3 1 3



ART	BARCODE	ST.	PREZZO
10 04 03	4000150742337		6,25

INNAFFIATOIO "EDEN" PE AZZURRO 2L GELI

UV1	UV2	IMBALLO
1	10	1/5 BK



4 0 0 0 1 5 0 7 4 2 3 3 7



ART	BARCODE	ST.	PREZZO
10 04 04	4000150700030		6,25

INNAFFIATOIO "EDEN" PE PINK 2L GELI

UV1	UV2	IMBALLO
1	10	1/5 BK



4 0 0 0 1 5 0 7 0 0 0 3 0



ART	BARCODE	ST.	PREZZO
10 04 33	4000150720335	A	3,80

INNAFFIATOIO "COLOURS" AZZURRO 1L GELI

UV1	UV2	IMBALLO
1	10	1/10 BK



4 0 0 0 1 5 0 7 2 0 3 3 5



ART	BARCODE	ST.	PREZZO
10 04 34	4000150720410	A	4,05

INNAFFIATOIO "COLOURS" PE AZZURRO 2L GELI

UV1	UV2	IMBALLO
1	10	1/10 BK



4 0 0 0 1 5 0 7 2 0 4 1 0



ART	BARCODE	ST.	PREZZO
10 04 11	4000150720212		4,15

INNAFFIATOIO PE VERDE 2L GELI

UV1	UV2	IMBALLO
1	10	1/10 BK



4 0 0 0 1 5 0 7 2 0 2 1 2



ART	BARCODE	ST.	PREZZO
10 04 12	4000150720311		4,55

INNAFFIATOIO PE VERDE 3L GELI

UV1	UV2	IMBALLO
1	10	1/10 BK



4 0 0 0 1 5 0 7 2 0 3 1 1



ART	BARCODE	ST.	PREZZO
10 04 13	4000150720519		5,20

INNAFFIATOIO PE VERDE 5L GELI

UV1	UV2	IMBALLO
1	10	1/10 BK



4 0 0 0 1 5 0 7 2 0 5 1 9



ART	BARCODE	ST.	PREZZO
10 04 15	4000150721011		7,95

INNAFFIATOIO PE VERDE 10L GELI

UV1	UV2	IMBALLO
1	12	1/12 BK



4 0 0 0 1 5 0 7 2 1 0 1 1



ART	BARCODE	ST.	PREZZO
10 04 16	4000150721417		12,25

INNAFFIATOIO PE VERDE 14L GELI

UV1	UV2	IMBALLO
1	5	1/10 BK



4 0 0 0 1 5 0 7 2 1 4 1 7



ART	BARCODE	ST.	PREZZO
10 04 30	4000150720342	A	3,80

INNAFFIATOIO "COLOURS" PE VERDE MENTA 1L GELI

UV1	UV2	IMBALLO
1	10	1/10 BK



4 0 0 0 1 5 0 7 2 0 3 4 2



ART	BARCODE	ST.	PREZZO
10 04 31*	4000150720373	A	4,05

INNAFFIATOIO "COLOURS" PE VERDE
MENTA 2L GELI

UV1	UV2	IMBALLO
1	10	1/10 BK



4 0 0 0 1 5 0 7 2 0 3 7 3



ART	BARCODE	ST.	PREZZO
10 04 36*	4000150720274	A	3,80

INNAFFIATOIO "COLOURS" PE PINK 1L
GELI

UV1	UV2	IMBALLO
1	10	1/10 BK



4 0 0 0 1 5 0 7 2 0 2 7 4



ART	BARCODE	ST.	PREZZO
10 04 37*	4000150720397	A	4,05

INNAFFIATOIO "COLOURS" PE PINK 2L
GELI

UV1	UV2	IMBALLO
1	10	1/10 BK



4 0 0 0 1 5 0 7 2 0 3 9 7



ART	BARCODE	ST.	PREZZO
10 11 18	9001404248006		8,60

RACCOGLIMIRTILLI LEGNO

UV1	UV2	IMBALLO
1	25	1/25 BK



9 0 0 1 4 0 4 2 4 8 0 0 6



ART	BARCODE	ST.	PREZZO
11 11 01	9001404237000		0,85

TRAPPOLA PER TOPI LEGNO

UV1	UV2	IMBALLO
1	20	1/20 BK



9 0 0 1 4 0 4 2 3 7 0 0 0



ART	BARCODE	ST.	PREZZO
07 30 22	8004537730227	A	5,50

POSACENERE IMPILABILE ACCIAIO
INOSSIDABILE Ø8 X 3 CM EVA

UV1	UV2	IMBALLO
1	6	1/6/48 AL



8 0 0 4 5 3 7 7 3 0 2 2 7



ART	BARCODE	ST.	PREZZO
07 30 23	8004537730234	A	7,60

POSACENERE IMPILABILE ACCIAIO
INOSSIDABILE Ø10 X 3 CM EVA

UV1	UV2	IMBALLO
1	6	1/6/48 AL



8 0 0 4 5 3 7 7 3 0 2 3 4



ART	BARCODE	ST.	PREZZO
07 30 16	8004537730166	A	7,90

POSACENERE ANTIVENTO ACCIAIO
INOSSIDABILE 8CM EVA

UV1	UV2	IMBALLO
1	6	1/48 PB



8 0 0 4 5 3 7 7 3 0 1 6 6



ART	BARCODE	ST.	PREZZO
07 30 15	8004537730159		9,40

POSACENERE ANTIVENTO ACCIAIO
INOSSIDABILE Ø10CM EVA

UV1	UV2	IMBALLO
1	6	1/6/60 PB



8 0 0 4 5 3 7 7 3 0 1 5 9



ART	BARCODE	ST.	PREZZO
07 30 21*	8004537730210	H	6,20

POSACENERE IMPILABILE ACCIAIO
INOSSIDABILE Ø13,5 X 3 CM EVA

UV1	UV2	IMBALLO
1	6	1/6/48 AL



8 0 0 4 5 3 7 7 3 0 2 1 0



ART	BARCODE	ST.	PREZZO
07 30 17	8004537730173		7,75

POSACENERE A PULSANTE ACCIAIO
INOSSIDABILE 11CM EVA

UV1	UV2	IMBALLO
1	12	1/12/60 PB



8 0 0 4 5 3 7 7 3 0 1 7 3



ART	BARCODE	ST.	PREZZO
07 30 08	8004537730081	A	4,50

POSACENERE BASCULANTE ACCIAIO
INOSSIDABILE 10CM EVA

UV1	UV2	IMBALLO
1	6	1/6/48 PB



8 0 0 4 5 3 7 7 3 0 0 8 1



ART	BARCODE	ST.	PREZZO
07 30 01	4009085131803	A	4,05

POSACENERE IMPILABILE MELAMINA
BIANCO 10CM WACA

UV1	UV2	IMBALLO
1	5	1/5 BK



4 0 0 9 0 8 5 1 3 1 8 0 3



ART	BARCODE	ST.	PREZZO
07 30 02	4009085132206	A	3,95

POSACENERE IMPILABILE MELAMINA
ROSSO 10CM WACA

UV1	UV2	IMBALLO
1	5	1/5 BK



4 0 0 9 0 8 5 1 3 2 2 0 6



ART	BARCODE	ST.	PREZZO
07 30 03	4009085133005		4,05

POSACENERE IMPILABILE MELAMINA
NERO 10CM WACA

UV1	UV2	IMBALLO
1	5	1/5 BK



4 0 0 9 0 8 5 1 3 3 0 0 5



ART	BARCODE	ST.	PREZZO
07 30 04	4009085020725		6,20

POSACENERE ANTIVENTO MELAMINA
BIANCO 10CM WACA

UV1	UV2	IMBALLO
1	5	1/5 BK



4 0 0 9 0 8 5 0 2 0 7 2 5



ART	BARCODE	ST.	PREZZO
07 30 05	4009085020732	A	5,95

POSACENERE ANTIVENTO MELAMINA
ROSSO 10CM WACA

UV1	UV2	IMBALLO
1	5	1/5 BK



4 0 0 9 0 8 5 0 2 0 7 3 2



ART	BARCODE	ST.	PREZZO
07 30 06	4009085010924		6,20

POSACENERE ANTIVENTO MELAMINA
NERO 10CM WACA

UV1	UV2	IMBALLO
1	5	1/5 BK



4 0 0 9 0 8 5 0 1 0 9 2 4



ART	BARCODE	ST.	PREZZO
07 05 84	4006822820204		5,50

OLIO COMBUSTIBILE AROMATICO
NEUTRO 1L

UV1	UV2	IMBALLO
1	12	1/12 BK



4 0 0 6 8 2 2 8 2 0 2 0 4

Pattumiere Pattumiere Differenziate



ART	BARCODE	ST.	PREZZO
04 22 10	4009808367618	A	16,50

PATTUMIERA ASSORTITO PP 15,0 L
BUCHSTEINER

UV1	UV2	IMBALLO
1	4	1/4 BK



4 0 0 9 8 0 8 3 6 7 6 1 8



ART	BARCODE	ST.	PREZZO
04 63 11	7610859135360		8,75

PATTUMIERA BASCULANTE 'TWIST'
NERO/ARGENTO PP 10L ROTHO

UV1	UV2	IMBALLO
1	3	1/3 AL



7 6 1 0 8 5 9 1 3 5 3 6 0



ART	BARCODE	ST.	PREZZO
04 63 12	7610859135391		13,75

PATTUMIERA BASCULANTE 'TWIST'
NERO/ARGENTO PP 25L ROTHO

UV1	UV2	IMBALLO
1	3	1/3 AL



7 6 1 0 8 5 9 1 3 5 3 9 1



ART	BARCODE	ST.	PREZZO
04 63 13	7610859135421		22,30

PATTUMIERA SWING ' TWIST'
NERO/ARGENTO PP 50L ROTHO

UV1	UV2	IMBALLO
1	3	1/3 AL



7 6 1 0 8 5 9 1 3 5 4 2 1



ART	BARCODE	ST.	PREZZO
04 63 41	7610859202451		21,50

PATTUMIERA SISTEMA RIFIUTI 'ALBULA
25L' CAPPUCCINO ROTHO

UV1	UV2	IMBALLO
1	3	1/3 AL



7 6 1 0 8 5 9 2 0 2 4 5 1



ART	BARCODE	ST.	PREZZO
04 63 42	7610859202482		21,50

PATTUMIERA SISTEMA RIFIUTI 'ALBULA
25L' VERDE ROTHO

UV1	UV2	IMBALLO
1	3	1/3 AL



7 6 1 0 8 5 9 2 0 2 4 8 2



ART	BARCODE	ST.	PREZZO
04 63 43	7610859202444		21,50

PATTUMIERA SISTEMA RIFIUTI 'ALBULA
25L' ANTRACITE ROTHO

UV1	UV2	IMBALLO
1	3	1/3 AL



7 6 1 0 8 5 9 2 0 2 4 4 4



ART	BARCODE	ST.	PREZZO
04 22 85	8004537422856		10,90

PATTUMIERA PEDALE CILINDRICA
ACCIAIO INOSSIDABILE 3L EVA

UV1	UV2	IMBALLO
1	6	1/6 LB



8 0 0 4 5 3 7 4 2 2 8 5 6



ART	BARCODE	ST.	PREZZO
04 22 86	8004537422863		13,60

PATTUMIERA PEDALE CILINDRICA
ACCIAIO INOSSIDABILE 5L EVA

UV1	UV2	IMBALLO
1	6	1/6 LB



8 0 0 4 5 3 7 4 2 2 8 6 3



ART	BARCODE	ST.	PREZZO
04 22 87	8004537422870		24,50

PATTUMIERA PEDALE CILINDRICA
ACCIAIO INOSSIDABILE 12L EVA

UV1	UV2	IMBALLO
1	4	1/4 LB



8 0 0 4 5 3 7 4 2 2 8 7 0



ART	BARCODE	ST.	PREZZO
04 22 89	8004537422894		42,00

PATTUMIERA PEDALE CILINDRICA
ACCIAIO INOSSIDABILE 20L EVA

UV1	UV2	IMBALLO
1	2	1/2 LB



8 0 0 4 5 3 7 4 2 2 8 9 4



ART	BARCODE	ST.	PREZZO
04 22 90	8004537422900		56,00

PATTUMIERA PEDALE CILINDRICA
ACCIAIO INOSSIDABILE 30L EVA

UV1	UV2	IMBALLO
1	2	1/2 LB



8 0 0 4 5 3 7 4 2 2 9 0 0



ART	BARCODE	ST.	PREZZO
04 63 51	7610859153494		36,60

PATTUMIERA A PEDALE DUO NERO
2x10L ROTHO

UV1	UV2	IMBALLO
1	2	1/1 AL



7 6 1 0 8 5 9 1 5 3 4 9 4



ART	BARCODE	ST.	PREZZO
04 63 52	7610859080097		76,90

PATTUMIERA A PEDALE TRIO NERO
1x11L, 2X15L ROTHO

UV1	UV2	IMBALLO
1	2	1/1 AL



7 6 1 0 8 5 9 0 8 0 0 9 7



ART	BARCODE	ST.	PREZZO
04 63 01	7610859135933		18,50

PATTUMIERA A PEDALE 'PASO'
NERO/ARGENTO PP 6 L ROTHO

UV1	UV2	IMBALLO
1	4	1/4 AL



7 6 1 0 8 5 9 1 3 5 9 3 3



ART	BARCODE	ST.	PREZZO
04 63 02	7610859118066		37,50

PATTUMIERA PEDALE 'PASO'
SILVER/NERO 20L ROTHO

UV1	UV2	IMBALLO
1	2	1/1 AL



7 6 1 0 8 5 9 1 1 8 0 6 6



ART	BARCODE	ST.	PREZZO
04 63 03	7610859118080		54,00

PATTUMIERA PEDALE 'PASO'
SILVER/NERO 40L ROTHO

UV1	UV2	IMBALLO
1	2	1/1 AL



7 6 1 0 8 5 9 1 1 8 0 8 0



ART	BARCODE	ST.	PREZZO
04 63 05	7610859146366		71,70

PATTUMIERA PEDALE DUO 'PASO'
SILVER/NERO 2X25L ROTHO

UV1	UV2	IMBALLO
1	2	1/1 AL



7 6 1 0 8 5 9 1 4 6 3 6 6



ART	BARCODE	ST.	PREZZO
04 26 11	7610859059550	A	9,40

CESTINO CARTA TRAPARENTE
"SPACEMAKER" 31X35CM 18L ROTHO

UV1	UV2	IMBALLO
1	5	1/5 BK



7 6 1 0 8 5 9 0 5 9 5 5 0



ART	BARCODE	ST.	PREZZO
04 63 31	7610859212153		10,20

SECCHIO COMPOST SISTEMA RIFIUTI
'ALBULA 6L' BLU ROTHO

UV1	UV2	IMBALLO
1	2	1/2 AL



7 6 1 0 8 5 9 2 1 2 1 5 3



ART	BARCODE	ST.	PREZZO
04 63 32	7610859212177		10,20

SECCHIO COMPOST SISTEMA RIFIUTI
'ALBULA 6L' VERDE LIME ROTHO

UV1	UV2	IMBALLO
1	2	1/2 AL



7 6 1 0 8 5 9 2 1 2 1 7 7



ART	BARCODE	ST.	PREZZO
04 63 33	7610859212139		10,20

SECCHIO COMPOST SISTEMA RIFIUTI
'ALBULA 6L' ANTRACITE ROTHO

UV1	UV2	IMBALLO
1	2	1/2 AL



7 6 1 0 8 5 9 2 1 2 1 3 9



ART	BARCODE	ST.	PREZZO
04 63 46	7610859225566		31,00

PATTUMIERA SISTEMA RIFIUTI 'ALBULA
40L' CAPPUCCINO ROTHO

UV1	UV2	IMBALLO
1	3	1/3 AL



7 6 1 0 8 5 9 2 2 5 5 6 6



ART	BARCODE	ST.	PREZZO
04 63 48	7610859225597		31,00

PATTUMIERA SISTEMA RIFIUTI 'ALBULA
40L' VERDE ROTHO

UV1	UV2	IMBALLO
1	3	1/3 AL



7 6 1 0 8 5 9 2 2 5 5 9 7



ART	BARCODE	ST.	PREZZO
04 63 47	7610859225580		31,00
PATTUMIERA SISTEMA RIFIUTI 'ALBULA 40L' VERDE LIME ROTHO			
UV1	UV2	IMBALLO	
1	3	1/3 AL	



7 6 1 0 8 5 9 2 2 5 5 8 0



ART	BARCODE	ST.	PREZZO
04 63 49	7610859225559		31,00
PATTUMIERA SISTEMA RIFIUTI 'ALBULA 40L' ANTRACITE ROTHO			
UV1	UV2	IMBALLO	
1	3	1/3 AL	



7 6 1 0 8 5 9 2 2 5 5 5 9



ART	BARCODE	ST.	PREZZO
04 63 20	7610859153791		9,65
PATTUMIERA UMIDIO+FILTRO CARBONE PP 8L 23X22X28 CM ROTHO			
UV1	UV2	IMBALLO	
1	4	1/4 AL	



7 6 1 0 8 5 9 1 5 3 7 9 1



ART	BARCODE	ST.	PREZZO
04 63 55	4052021001616	A	71,50
PATTUMIERA CON ROUTE 'ATLAS' NERO/VERDE PP 100 L ROTHO			
UV1	UV2	IMBALLO	
1	2	1/1 BK	



4 0 5 2 0 2 1 0 0 1 6 1 6



ART	BARCODE	ST.	PREZZO
04 63 21	7610859038029		3,60
3 RICAMBIO FILTRO CARBONE PER PATTUMIERA UMIDO ROTHO			
UV1	UV2	IMBALLO	
1	2	1/10 SP	



7 6 1 0 8 5 9 0 3 8 0 2 9

Pulire Spazzolare



ART	BARCODE	ST.	PREZZO
04 20 24	4006501566133	A	8,95

RICAMBIO PANNO PICOBELLO MICRODUO 33CM LEIFHEIT

UV1	UV2	IMBALLO
1	6	1/6 CD



4 0 0 6 5 0 1 5 6 6 1 3 3



ART	BARCODE	ST.	PREZZO
04 20 18	4006501521019		44,50

SET LAVAPAVIMENTI 'CLEAN TWIST DISC MOP' + SECCHIO LEIFHEIT

UV1	UV2	IMBALLO
1	3	1/1 PB



4 0 0 6 5 0 1 5 2 1 0 1 9



ART	BARCODE	ST.	PREZZO
04 20 19	4006501520951		6,95

PANNO RICAMBIO LAVAPAVIMENTI 'CLEAN TWIST DISC MOP' LEIFHEIT

UV1	UV2	IMBALLO
1	3	1/6 PH



4 0 0 6 5 0 1 5 2 0 9 5 1



ART	BARCODE	ST.	PREZZO
04 20 25	4006501511201		22,50

LAVAVETRI SNODABILE MICROFIBRA 32CM LEIFHEIT

UV1	UV2	IMBALLO
1	3	1/6 CD



4 0 0 6 5 0 1 5 1 1 2 0 1



ART	BARCODE	ST.	PREZZO
04 20 20	4006501510037	A	79,50

SET LAVAVETRI ASPIRANTE 'DRY & CLEAN' 43CM LEIFHEIT

UV1	UV2	IMBALLO
1	2	1/2 HB



4 0 0 6 5 0 1 5 1 0 0 3 7



ART	BARCODE	ST.	PREZZO
04 20 27	4006501513205		14,60

LAVAVETRI PLUS3 MICROFIBRA 32CM LEIFHEIT

UV1	UV2	IMBALLO
1	3	1/6 SL



4 0 0 6 5 0 1 5 1 3 2 0 5



ART	BARCODE	ST.	PREZZO
04 45 71	4002403005435		7,20

LAVAVETRI BIANCO SOFTGRIP 25CM HAUG

UV1	UV2	IMBALLO
1	10	1/10 BK



4 0 0 2 4 0 3 0 0 5 4 3 5



ART	BARCODE	ST.	PREZZO
04 45 72	4002403007606		7,50

LAVAVETRI BIANCO 35CM HAUG

UV1	UV2	IMBALLO
1	10	1/10 BK



4 0 0 2 4 0 3 0 0 7 6 0 6



ART	BARCODE	ST.	PREZZO
04 21 21	9001629700105		6,50

BATTIPANNI IN RATTAN MIS.3 - 70X24CM MASTA

UV1	UV2	IMBALLO
1	10	1/10 HT



9 0 0 1 6 2 9 7 0 0 1 0 5



ART	BARCODE	ST.	PREZZO
04 21 23	9001629353172		3,75

SPAZZOLA LAVA-THERMOS 33 CM MASTA

UV1	UV2	IMBALLO
1	5	1/5 BK



9 0 0 1 6 2 9 3 5 3 1 7 2



ART	BARCODE	ST.	PREZZO
04 21 25	9001629300107		2,70

SPAZZOLA LAVABOTTIGLIE NYLON+LANA Ø3,8 33CM MASTA

UV1	UV2	IMBALLO
1	10	1/10/100 BK



9 0 0 1 6 2 9 3 0 0 1 0 7



ART	BARCODE	ST.	PREZZO
04 21 26	9001629300206		3,25

SPAZZOLA LAVABOTTIGLIE NYLON+LANA Ø4,8 37CM MASTA

UV1	UV2	IMBALLO
1	10	1/10/100 BK



9 0 0 1 6 2 9 3 0 0 2 0 6



ART	BARCODE	ST.	PREZZO
04 21 27	9001629300305		3,80

SPAZZOLA LAVABOTTIGLIE NYLON+LANA Ø6,5 49CM MASTA

UV1	UV2	IMBALLO
1	10	1/10/100 BK



9 0 0 1 6 2 9 3 0 0 3 0 5



ART	BARCODE	ST.	PREZZO
04 21 29	9001629301203		2,30

SPAZZOLA LAVABOTTIGLIE NYLON 1/4L 33CM MASTA

UV1	UV2	IMBALLO
1	10	1/100 BK



9 0 0 1 6 2 9 3 0 1 2 0 3



ART	BARCODE	ST.	PREZZO
04 21 30	9001629301302		2,80

SPAZZOLA LAVABOTTIGLIE NYLON 1/2L 35CM MASTA

UV1	UV2	IMBALLO
1	10	1/100 BK



9 0 0 1 6 2 9 3 0 1 3 0 2



ART	BARCODE	ST.	PREZZO
04 21 31	9001629301401		3,50

SPAZZOLA LAVABOTTIGLIE NYLON 1L 47CM MASTA

UV1	UV2	IMBALLO
1	10	1/50 BK



9 0 0 1 6 2 9 3 0 1 4 0 1



ART	BARCODE	ST.	PREZZO
04 21 32	9001629301500		3,90

SPAZZOLA LAVABOTTIGLIE 2L NYLON 57CM MASTA

UV1	UV2	IMBALLO
1	10	1/100 BK



9 0 0 1 6 2 9 3 0 1 5 0 0



ART	BARCODE	ST.	PREZZO
04 21 33	9001629302101		1,90

SPAZZOLA BOCCHETTE NYLON Ø1CM MASTA

UV1	UV2	IMBALLO
1	10	1/10/200 BK



9 0 0 1 6 2 9 3 0 2 1 0 1



ART	BARCODE	ST.	PREZZO
04 21 34	9001629302200		1,95

SPAZZOLA BOCCHETTE NYLON Ø 2CM MASTA

UV1	UV2	IMBALLO
1	10	1/10/100 BK



9 0 0 1 6 2 9 3 0 2 2 0 0



ART	BARCODE	ST.	PREZZO
04 23 01	4007267820293		1,20

3 SPUGNE PER STOVIGLIE CON LATO ABRASIVO SANTEX

UV1	UV2	IMBALLO
1	10	1/60 CT



4 0 0 7 2 6 7 8 2 0 2 9 3



ART	BARCODE	ST.	PREZZO
04 23 14	4007267820002		3,45

4 SPUGNA 'POWERCLEAN' SANTEX

UV1	UV2	IMBALLO
1	7	1/28 PG



4 0 0 7 2 6 7 8 2 0 0 0 2



ART	BARCODE	ST.	PREZZO
04 23 15	4007267823027		2,95

5 PANNO SPUGNA SANTEX

UV1	UV2	IMBALLO
1	10	1/50 PG



4 0 0 7 2 6 7 8 2 3 0 2 7



ART	BARCODE	ST.	PREZZO
04 23 05	4007267824024		1,60

3 PANNO UNIVERSALE 38X38CM SANTEX

UV1	UV2	IMBALLO
1	10	1/50 PG



4 0 0 7 2 6 7 8 2 4 0 2 4



ART	BARCODE	ST.	PREZZO
04 20 15	4006501552105		16,20

LAVAPAVIMENTI 'CLASSIC XL' MANICO TELESCOPICO LEIFHEIT

UV1	UV2	IMBALLO
1	6	1/6 CD



4 0 0 6 5 0 1 5 5 2 1 0 5



ART	BARCODE	ST.	PREZZO
04 20 16	4006501552112		8,95

PANNO RICAMBIO LAVAPAVIMENTI 'CLASSIC XL' LEIFHEIT

UV1	UV2	IMBALLO
1	6	1/6/48 CD



4 0 0 6 5 0 1 5 5 2 1 1 2



ART	BARCODE	ST.	PREZZO
04 20 03	4006501119506	A	47,00

SCOPA MECCANICA REGULUS SUPRA PLASTICA LEIFHEIT

UV1	UV2	IMBALLO
1	5	1/5 HB



4 0 0 6 5 0 1 1 1 9 5 0 6



ART	BARCODE	ST.	PREZZO
04 23 11	4007267270012		6,30

PANNO LAVAVETRO/STOVIGLIE MICROFIBRA 50X60CM SANTEX

UV1	UV2	IMBALLO
1	5	1/20 PH



4 0 0 7 2 6 7 2 7 0 0 1 2



ART	BARCODE	ST.	PREZZO
04 23 06	4007267824017		1,80

STROFINACCIO PER PAVIMENTI 50X60CM SANTEX

UV1	UV2	IMBALLO
1	12	1/50 PG



4 0 0 7 2 6 7 8 2 4 0 1 7



ART	BARCODE	ST.	PREZZO
04 23 10	4007267813417	A	4,95

PANNO PER LUCIDARE MICROFIBRA 30X40CM SANTEX

UV1	UV2	IMBALLO
1	5	1/25 CD



4 0 0 7 2 6 7 8 1 3 4 1 7



ART	BARCODE	ST.	PREZZO
04 23 41	8004537423419		4,10

RASCHIETTO PULISCI PIASTE COLOR 15CM EVA

UV1	UV2	IMBALLO
4	16	1/4/160 BC



8 0 0 4 5 3 7 4 2 3 4 1 9



ART	BARCODE	ST.	PREZZO
04 23 42	8004537423426		3,95

RASCHIETTO PULISCI PIASTE ACCIAIO INOSSIDABILE 14CM EVA

UV1	UV2	IMBALLO
1	15	1/15 BC



8 0 0 4 5 3 7 4 2 3 4 2 6



ART	BARCODE	ST.	PREZZO
04 23 43	8004537423433		2,70

5 LAME RICAMBIO RASCHIETTO ACCIAIO INOSSIDABILE 042342 EVA

UV1	UV2	IMBALLO
1	10	1/50 BC



8 0 0 4 5 3 7 4 2 3 4 3 3



ART	BARCODE	ST.	PREZZO
04 23 46	4007267872063		2,05

4 PAGLIETTE PENTOLE/GRILL ACCIAIO INOSSIDABILE SANTEX

UV1	UV2	IMBALLO
1	5	1/20 BC



4 0 0 7 2 6 7 8 7 2 0 6 3



ART	BARCODE	ST.	PREZZO
04 21 05	8004537421057	A	5,90

ALZA IMMONDIZIE METALLO EVA

UV1	UV2	IMBALLO
1	24	1/1 BK



8 0 0 4 5 3 7 4 2 1 0 5 7



ART	BARCODE	ST.	PREZZO
04 48 77	9001629720509		3,92

PALETTA POLVERE ZINCATA 22X38CM MASTA

UV1	UV2	IMBALLO
1	10	1/10 BK



9 0 0 1 6 2 9 7 2 0 5 0 9



ART	BARCODE	ST.	PREZZO
04 21 12	9001629720004	A	1,30

PALETTA POLVERE PLASTICA BORDO GOMMA ASSORTITA MASTA

UV1	UV2	IMBALLO
1	10	1/10 BK



9 0 0 1 6 2 9 7 2 0 0 0 4



ART	BARCODE	ST.	PREZZO
04 21 01	9001629720400		8,50

PALETTA POLVERE ACCIAIO INOSSIDABILE

UV1	UV2	IMBALLO
1	10	1/10 BK



9 0 0 1 6 2 9 7 2 0 4 0 0



ART	BARCODE	ST.	PREZZO
04 21 04	9001629720301		4,70

PALETTA POLVERE VERNICIATA

UV1	UV2	IMBALLO
1	10	1/10 BK



9 0 0 1 6 2 9 7 2 0 3 0 1



ART	BARCODE	ST.	PREZZO
04 48 78	9001629720707	A	3,85

PALETTA POLVERE METALLO VERNICIATO CON BORDO IN GOMMA

UV1	UV2	IMBALLO
1	10	1/10 BK



9 0 0 1 6 2 9 7 2 0 7 0 7



ART	BARCODE	ST.	PREZZO
04 21 11	9001629720202		3,15

COMPLETO PULIZIA ASSORTITO MASTA

UV1	UV2	IMBALLO
1	12	1/12 AL



9 0 0 1 6 2 9 7 2 0 2 0 2



ART	BARCODE	ST.	PREZZO
02 30 63	4006160637854		45,00

PULITORE A VAPORE DR3653 1050W CLATRONIC

UV1	UV2	IMBALLO
1	6	1/6 PB



4 0 0 6 1 6 0 6 3 7 8 5 4



ART	BARCODE	ST.	PREZZO
04 45 61	4002403005701		6,45

SCOPA LEGNO SENZA MANICO 28CM HAUG

UV1	UV2	IMBALLO
1	10	1/10 BK



4 0 0 2 4 0 3 0 0 5 7 0 1



ART	BARCODE	ST.	PREZZO
04 45 54	4002403006036		4,60

SPAZZOLA PULIZIE 'FLEXO' COLORI ASSORTITI HAUG

UV1	UV2	IMBALLO
1	10	1/10/100 AL



4 0 0 2 4 0 3 0 0 6 0 3 6



ART	BARCODE	ST.	PREZZO
04 45 55	4002403005022		2,85

SPAZZOLA BUCATO FORMA S LEGNO+PP HAUG

UV1	UV2	IMBALLO
1	10	1/10/50 BK



4 0 0 2 4 0 3 0 0 5 0 2 2



ART	BARCODE	ST.	PREZZO
04 45 62	4002403005831		3,95

SPAZZOLONE LEGNO SENZA MANICO 22,5CM HAUG

UV1	UV2	IMBALLO
1	10	1/10 BK



4 0 0 2 4 0 3 0 0 5 8 3 1



ART	BARCODE	ST.	PREZZO
04 45 56	4002403005749		3,35

SPAZZOLA LEGNO+SETOLE HAUG

UV1	UV2	IMBALLO
1	10	1/10 BK



4 0 0 2 4 0 3 0 0 5 7 4 9



ART	BARCODE	ST.	PREZZO
04 45 60	4002403007033		2,90

MANICO SCOPA METALLO NERO 130CM HAUG

UV1	UV2	IMBALLO
1	10	1/20 BK



4 0 0 2 4 0 3 0 0 7 0 3 3



ART	BARCODE	ST.	PREZZO
04 45 85	4002403005688		3,35

SPAZZOLA ABITI LEGNO 17CM HAUG

UV1	UV2	IMBALLO
1	10	1/10 BK



4 0 0 2 4 0 3 0 0 5 6 8 8



ART	BARCODE	ST.	PREZZO
04 20 35	4006501410009		8,20

SPAZZOLA TESSUTI DRESSETTA 26X6CM LEIFHEIT

UV1	UV2	IMBALLO
1	5	1/10 HB



4 0 0 6 5 0 1 4 1 0 0 0 9



ART	BARCODE	ST.	PREZZO
04 45 80	4002403007675	A	7,10

SPAZZOLA BAGNO MANICO ASPORTABILE COLORI ASSORTITI HAUG

UV1	UV2	IMBALLO
1	10	1/10 BK



4 0 0 2 4 0 3 0 0 7 6 7 5



ART	BARCODE	ST.	PREZZO
04 45 75	4002403009020		6,10

SPAZZOLA/RASCHIETTO AUTO 'TOPFLOP' HAUG

UV1	UV2	IMBALLO
1	20	1/20 BK



4 0 0 2 4 0 3 0 0 9 0 2 0



ART	BARCODE	ST.	PREZZO
04 45 45	4002403603051		2,00

LAVAPIATTI 'LILI' LEGNO E FIBRA NATURALE HAUG

UV1	UV2	IMBALLO
1	10	1/10/50 BK



4 0 0 2 4 0 3 6 0 3 0 5 1



ART	BARCODE	ST.	PREZZO
04 45 46	4002403001543		1,50

LAVAPIATTI OVALE PLASTICA COLORI ASSORTITI HAUG

UV1	UV2	IMBALLO
1	10	1/10/100 BK



4 0 0 2 4 0 3 0 0 1 5 4 3



ART	BARCODE	ST.	PREZZO
04 45 44	4002403001284		4,60

LAVAPIATTI CON DOSATORE 'SPÜLI RONDO' ASSORTITO HAUG BÜRSTEN

UV1	UV2	IMBALLO
1	10	1/10/100 CD



4 0 0 2 4 0 3 0 0 1 2 8 4



ART	BARCODE	ST.	PREZZO
04 45 47	4002403003585	A	5,90

LAVAPIATTI 'GECKO' COLORI ASSORTITI HAUG

UV1	UV2	IMBALLO
1	16	1/16/160 BK



4 0 0 2 4 0 3 0 0 3 5 8 5



ART	BARCODE	ST.	PREZZO
02 61 61	4007224005978	A	27,50

LUQUIDO PULISCISCARPE 'M2798' BOMANN

UV1	UV2	IMBALLO
1	6	1/6/36 BK



4 0 0 7 2 2 4 0 0 5 9 7 8



ART	BARCODE	ST.	PREZZO
04 26 10	7610859153210		10,00

SECCHIO RETTANGOLARE 'BASIC' PP 12L 38X26X23 CM ROTHO

UV1	UV2	IMBALLO
1	3	1/3 AL



7 6 1 0 8 5 9 1 5 3 2 1 0



ART	BARCODE	ST.	PREZZO
04 26 16	9002427255002		4,95

SECCHIO PLASTICA DECORI ASSORTITI 10L TEKO PLASTIC

UV1	UV2	IMBALLO
1	5	1/10 BK



9 0 0 2 4 2 7 2 5 5 0 0 2



ART	BARCODE	ST.	PREZZO
04 37 30	4007267811130		3,50

2 FILTRO CAPPA ASPIRANTE 57X47CM SANTEX

UV1	UV2	IMBALLO
1	25	1/25 PG



4 0 0 7 2 6 7 8 1 1 1 3 0



ART	BARCODE	ST.	PREZZO
04 37 31	4007267811123		5,80

FILTRO CAPPA ASPIRANTE 57X47CM SANTEX

UV1	UV2	IMBALLO
1	10	1/5 PG



4 0 0 7 2 6 7 8 1 1 1 2 3



ART	BARCODE	ST.	PREZZO
04 37 04	8021084645095		4,60
TAPPETINO ANTIMUFFA RITAGLIABILE 47X30CM			
UV1	UV2	IMBALLO	
1	10	1/12/48 PH	



8 0 2 1 0 8 4 6 4 5 0 9 5

Bottiglie Isolanti Portavivande



ART	BARCODE	ST.	PREZZO
06 02 11	8004537602111		5,80

PORTAVIVANDE+INTERNO COLORI ASSORTITI 0,5 L EVA

UV1	UV2	IMBALLO
1	12	1/24 PB



8 0 0 4 5 3 7 6 0 2 1 1 1



ART	BARCODE	ST.	PREZZO
06 02 12	8004537602128		7,25

PORTAVIVANDE+INTERNO COLORI ASSORTITI 0,8 L EVA

UV1	UV2	IMBALLO
1	12	1/24 PB



8 0 0 4 5 3 7 6 0 2 1 2 8



ART	BARCODE	ST.	PREZZO
06 02 13	8004537602135		8,30

PORTAVIVANDE+INTERNO COLORI ASSORTITI 1,0 L EVA

UV1	UV2	IMBALLO
1	12	1/12 PB



8 0 0 4 5 3 7 6 0 2 1 3 5



ART	BARCODE	ST.	PREZZO
06 02 14	8004537602142		8,95

PORTAVIVANDE+INTERNO COLORI ASSORTITI 1,2 L EVA

UV1	UV2	IMBALLO
1	12	1/12 PB



8 0 0 4 5 3 7 6 0 2 1 4 2



ART	BARCODE	ST.	PREZZO
06 02 01	8004537602012	A	9,00

PORTAVIVANDE+INTERNO 'EXTRATHERM' 0,5 L EVA

UV1	UV2	IMBALLO
1	12	1/24 PB



8 0 0 4 5 3 7 6 0 2 0 1 2



ART	BARCODE	ST.	PREZZO
06 02 03	8004537602036	A	11,00

PORTAVIVANDE+INTERNO 'EXTRATHERM' 1L EVA

UV1	UV2	IMBALLO
1	12	1/12 PB



8 0 0 4 5 3 7 6 0 2 0 3 6



ART	BARCODE	ST.	PREZZO
06 02 04	8004537602043	A	12,00

PORTAVIVANDE+INTERNO 'EXTRATHERM' 1,2L EVA

UV1	UV2	IMBALLO
1	12	1/12 PB



8 0 0 4 5 3 7 6 0 2 0 4 3



ART	BARCODE	ST.	PREZZO
06 02 29	8004537602296		8,50

PORTAVIVANDE+INTERNO 1 L EVA

UV1	UV2	IMBALLO
1	12	1/12 PB



8 0 0 4 5 3 7 6 0 2 2 9 6



ART	BARCODE	ST.	PREZZO
06 02 30	8004537602302		9,50

PORTAVIVANDE+INTERNO 1,5 L EVA

UV1	UV2	IMBALLO
1	12	1/12 PB



8 0 0 4 5 3 7 6 0 2 3 0 2



ART	BARCODE	ST.	PREZZO
06 02 31	8004537602319		10,50

PORTAVIVANDE+INTERNO 2 L EVA

UV1	UV2	IMBALLO
1	6	1/6 PB



8 0 0 4 5 3 7 6 0 2 3 1 9



ART	BARCODE	ST.	PREZZO
06 02 32	8004537602326		12,00

PORTAVIVANDE+INTERNO 3 L EVA

UV1	UV2	IMBALLO
1	6	1/6 PB



8 0 0 4 5 3 7 6 0 2 3 2 6



ART	BARCODE	ST.	PREZZO
06 04 08	4007389850086		24,50

PORTAVIVANDE+CUCCHIAIO BLU ROYAL 0,85L ROTPUNKT

UV1	UV2	IMBALLO
1	6	1/6 BK



4 0 0 7 3 8 9 8 5 0 0 8 6



ART	BARCODE	ST.	PREZZO
06 04 07	4007389850710		24,50

PORTAVIVANDE+INTERNO ROSSO 0,85L
ROTPUNKT

UV1	UV2	IMBALLO
1	6	1/6 BK



4 0 0 7 3 8 9 8 5 0 7 1 0



ART	BARCODE	ST.	PREZZO
06 04 10	4007389850147		24,50

PORTAVIVANDE+CUCCHIAIO BLU
HYPERBLUE 0,85L ROTPUNKT

UV1	UV2	IMBALLO
1	6	1/6 BK



4 0 0 7 3 8 9 8 5 0 1 4 7



ART	BARCODE	ST.	PREZZO
06 03 61	8004537603613		9,50

PORTAVIVANDE ACCIAIO INOX 0.35L EVA

UV1	UV2	IMBALLO
1	6	1/6/24 PB



8 0 0 4 5 3 7 6 0 3 6 1 3



ART	BARCODE	ST.	PREZZO
06 03 62	8004537603620		9,90

PORTAVIVANDE ACCIAIO INOX 0.50L EVA

UV1	UV2	IMBALLO
1	6	1/6/24 PB



8 0 0 4 5 3 7 6 0 3 6 2 0



ART	BARCODE	ST.	PREZZO
06 03 63	8004537603637		10,90

PORTAVIVANDE ACCIAIO INOX 0.75L EVA

UV1	UV2	IMBALLO
1	6	1/6/24 PB



8 0 0 4 5 3 7 6 0 3 6 3 7



ART	BARCODE	ST.	PREZZO
06 03 64	8004537603644		11,50

PORTAVIVANDE ACCIAIO INOX 1.00L EVA

UV1	UV2	IMBALLO
1	6	1/6/24 PB



8 0 0 4 5 3 7 6 0 3 6 4 4



ART	BARCODE	ST.	PREZZO
06 03 71	8004537603712		10,50

PORTAVIVANDE ACCIAIO INOX BLU
OPACO 0.35L EVA

UV1	UV2	IMBALLO
1	6	1/6/24 PB



8 0 0 4 5 3 7 6 0 3 7 1 2



ART	BARCODE	ST.	PREZZO
06 03 72	8004537603729		10,90

PORTAVIVANDE ACCIAIO INOX BLU
OPACO 0.50L EVA

UV1	UV2	IMBALLO
1	6	1/6/24 PB



8 0 0 4 5 3 7 6 0 3 7 2 9



ART	BARCODE	ST.	PREZZO
06 03 73	8004537603736		11,90

PORTAVIVANDE ACCIAIO INOX BLU
OPACO 0.75L EVA

UV1	UV2	IMBALLO
1	6	1/6/24 PB



8 0 0 4 5 3 7 6 0 3 7 3 6



ART	BARCODE	ST.	PREZZO
06 03 74	8004537603743		12,50

PORTAVIVANDE ACCIAIO INOX BLU
OPACO 1.00L EVA

UV1	UV2	IMBALLO
1	6	1/6/24 PB



8 0 0 4 5 3 7 6 0 3 7 4 3



ART	BARCODE	ST.	PREZZO
06 03 51	8004537603514	A	13,50

PORTAVIVANDE ACCIAIO INOX GRIGIO
OPACO 1/2 L EVA

UV1	UV2	IMBALLO
1	6	1/6/12 PB



8 0 0 4 5 3 7 6 0 3 5 1 4



ART	BARCODE	ST.	PREZZO
06 03 53	8004537603538	A	16,00

PORTAVIVANDE ACCIAIO INOX GRIGIO
OPACO 1.0 L EVA

UV1	UV2	IMBALLO
1	6	1/6/12 PB



8 0 0 4 5 3 7 6 0 3 5 3 8



ART	BARCODE	ST.	PREZZO
06 08 24*	8004537608243		7,25

**BOTTIGLIA ISOLANTE ACCIAIO
INOSSIDABILE 18/8 0,2 L EVA**

UV1	UV2	IMBALLO
1	6	1/24 PB



8 0 0 4 5 3 7 6 0 8 2 4 3



ART	BARCODE	ST.	PREZZO
06 08 20*	8004537608205		7,45

**BOTTIGLIA ISOLANTE ACCIAIO
INOSSIDABILE 18/8 0,35 L EVA**

UV1	UV2	IMBALLO
1	6	1/24 PB



8 0 0 4 5 3 7 6 0 8 2 0 5



ART	BARCODE	ST.	PREZZO
06 08 21*	8004537608212		8,30

**BOTTIGLIA ISOLANTE ACCIAIO
INOSSIDABILE 18/8 0,5 L EVA**

UV1	UV2	IMBALLO
1	6	1/24 PB



8 0 0 4 5 3 7 6 0 8 2 1 2



ART	BARCODE	ST.	PREZZO
06 08 22*	8004537608229		10,95

**BOTTIGLIA ISOLANTE ACCIAIO
INOSSIDABILE 18/8 0,75 L EVA**

UV1	UV2	IMBALLO
1	5	1/20 PB



8 0 0 4 5 3 7 6 0 8 2 2 9



ART	BARCODE	ST.	PREZZO
06 08 23*	8004537608236		12,80

**BOTTIGLIA ISOLANTE ACCIAIO
INOSSIDABILE 18/8 1 L EVA**

UV1	UV2	IMBALLO
1	5	1/20 PB



8 0 0 4 5 3 7 6 0 8 2 3 6



ART	BARCODE	ST.	PREZZO
06 08 04*	8004537608045		7,20

**BOTTIGLIA ISOLANTE ACCIAIO
INOSSIDABILE+TAPPO VITE 0,35L EVA**

UV1	UV2	IMBALLO
1	6	1/24 PB



8 0 0 4 5 3 7 6 0 8 0 4 5



ART	BARCODE	ST.	PREZZO
06 08 05*	8004537608052		7,90

**BOTTIGLIA ISOLANTE ACCIAIO
INOSSIDABILE +TAPPO VITE 0,5L EVA**

UV1	UV2	IMBALLO
1	6	1/24 PB



8 0 0 4 5 3 7 6 0 8 0 5 2



ART	BARCODE	ST.	PREZZO
06 08 06*	8004537608069		10,75

**BOTTIGLIA ISOLANTE ACCIAIO
INOSSIDABILE+TAPPO VITE 0,75L EVA**

UV1	UV2	IMBALLO
1	5	1/20 PB



8 0 0 4 5 3 7 6 0 8 0 6 9



ART	BARCODE	ST.	PREZZO
06 08 07*	8004537608076		12,50

**BOTTIGLIA ISOLANTE ACCIAIO
INOSSIDABILE +TAPPO VITE 1,0L EVA**

UV1	UV2	IMBALLO
1	5	1/20 PB



8 0 0 4 5 3 7 6 0 8 0 7 6



ART	BARCODE	ST.	PREZZO
12 22 40	8033237337290		9,90

**BOTTIGLIA ISOLANTE ANTRACITE
OPACO+TAPPO VITE 0,45L FOREVER**

UV1	UV2	IMBALLO
1	6	1/24 LB



8 0 3 3 2 3 7 3 3 7 2 9 0



ART	BARCODE	ST.	PREZZO
06 03 31	8004537603316		11,30

**BOTTIGLIA ISOLANTE GRIGIO
OPACO+TAPPO VITE 0,55L EVA**

UV1	UV2	IMBALLO
1	6	1/6/24 HT



8 0 0 4 5 3 7 6 0 3 3 1 6



ART	BARCODE	ST.	PREZZO
06 03 32	8004537603323		12,20

**BOTTIGLIA ISOLANTE GRIGIO
OPACO+TAPPO VITE 0,70L EVA**

UV1	UV2	IMBALLO
1	6	1/6/24 HT



8 0 0 4 5 3 7 6 0 3 3 2 3



ART	BARCODE	ST.	PREZZO
06 05 01	8004537605013		5,80

BOTTIGLIA ISOLANTE COLORI ASSORTITI
125ML EVA

UV1	UV2	IMBALLO
1	6	1/6/48 HT



8 0 0 4 5 3 7 6 0 5 0 1 3



ART	BARCODE	ST.	PREZZO
06 05 02	8004537605020		6,25

BOTTIGLIA ISOLANTE COLORI ASSORTITI
230ML EVA

UV1	UV2	IMBALLO
1	6	1/6/24 HT



8 0 0 4 5 3 7 6 0 5 0 2 0



ART	BARCODE	ST.	PREZZO
06 05 03	8004537605037		6,75

BOTTIGLIA ISOLANTE COLORI ASSORTITI
430 ML EVA

UV1	UV2	IMBALLO
1	6	1/6/24 HT



8 0 0 4 5 3 7 6 0 5 0 3 7



ART	BARCODE	ST.	PREZZO
06 05 04	8004537605044		7,60

BOTTIGLIA ISOLANTE COLORI ASSORTITI
600ML EVA

UV1	UV2	IMBALLO
1	6	1/6/24 HT



8 0 0 4 5 3 7 6 0 5 0 4 4



ART	BARCODE	ST.	PREZZO
06 05 05	8004537605051		8,70

BOTTIGLIA ISOLANTE COLORI ASSORTITI
1 L EVA

UV1	UV2	IMBALLO
1	6	1/6/24 HT



8 0 0 4 5 3 7 6 0 5 0 5 1



ART	BARCODE	ST.	PREZZO
06 05 28	8004537605280		8,40

BOTTIGLIA ISOLANTE ACCIAIO
INOSSID.ROSSO LUCIDO 0,35L EVA

UV1	UV2	IMBALLO
1	6	1/6/24 PB



8 0 0 4 5 3 7 6 0 5 2 8 0



ART	BARCODE	ST.	PREZZO
06 05 29	8004537605297		8,95

BOTTIGLIA ISOLANTE ACCIAIO INOSSID.
ROSSO LUCIDO 0,5L EVA

UV1	UV2	IMBALLO
1	6	1/6/24 PB



8 0 0 4 5 3 7 6 0 5 2 9 7



ART	BARCODE	ST.	PREZZO
06 05 30	8004537605303		11,70

BOTTIGLIA ISOLANTE ACCIAIO INOSSID.
ROSSO LUCIDO 0,75L EVA

UV1	UV2	IMBALLO
1	6	1/6/24 PB



8 0 0 4 5 3 7 6 0 5 3 0 3



ART	BARCODE	ST.	PREZZO
06 05 37	8004537605372	A	8,50

BOTTIGLIA ISOLANTE ACCIAIO INOSSID.
VIOLA LUCIDO 0,5L EVA

UV1	UV2	IMBALLO
1	6	1/6/24 PB



8 0 0 4 5 3 7 6 0 5 3 7 2



ART	BARCODE	ST.	PREZZO
06 05 38	8004537605389	A	11,10

BOTTIGLIA ISOLANTE ACCIAIO INOSSID.
VIOLA LUCIDO 0,75L EVA

UV1	UV2	IMBALLO
1	6	1/6/24 PB



8 0 0 4 5 3 7 6 0 5 3 8 9



ART	BARCODE	ST.	PREZZO
06 05 41	8004537605419		8,95

BOTTIGLIA ISOLANTE ACCIAIO INOSSID.
VERDE LUCIDO 0,5L EVA

UV1	UV2	IMBALLO
1	6	1/6/24 PB



8 0 0 4 5 3 7 6 0 5 4 1 9



ART	BARCODE	ST.	PREZZO
06 05 42	8004537605426		11,70

BOTTIGLIA ISOLANTE ACCIAIO INOSSID.
VERDE LUCIDO 0,75L EVA

UV1	UV2	IMBALLO
1	6	1/6/24 PB



8 0 0 4 5 3 7 6 0 5 4 2 6



ART	BARCODE	ST.	PREZZO
06 05 43*	8004537605433	H	13,00

BOTTIGLIA ISOL INOX VERDE LUCIDO 1L EVA

UV1	UV2	IMBALLO
1	5	1/5/20 PB



8 0 0 4 5 3 7 6 0 5 4 3 3



ART	BARCODE	ST.	PREZZO
06 05 20*	8004537605204		8,40

BOTTIGLIA ISOLANTE ACCIAIO INOSSID. BIANCO OPACO 0,35L EVA

UV1	UV2	IMBALLO
1	6	1/6/24 PB



8 0 0 4 5 3 7 6 0 5 2 0 4



ART	BARCODE	ST.	PREZZO
06 05 21*	8004537605211		8,95

BOTTIGLIA ISOLANTE ACCIAIO INOSSID. BIANCO OPACO 0,5L EVA

UV1	UV2	IMBALLO
1	6	1/6/24 PB



8 0 0 4 5 3 7 6 0 5 2 1 1



ART	BARCODE	ST.	PREZZO
06 05 22*	8004537605228		11,70

BOTTIGLIA ISOLANTE ACCIAIO INOSSID. BIANCO OPACO 0,75L EVA

UV1	UV2	IMBALLO
1	6	1/6/24 PB



8 0 0 4 5 3 7 6 0 5 2 2 8



ART	BARCODE	ST.	PREZZO
06 05 23*	8004537605235	H	13,00

BOTTIGLIA ISOLANTE ACCIAIO INOSSID. BIANCO OPACO 1,0 L EVA

UV1	UV2	IMBALLO
1	5	1/5/20 PB



8 0 0 4 5 3 7 6 0 5 2 3 5



ART	BARCODE	ST.	PREZZO
06 05 24*	8004537605242		8,40

BOTTIGLIA ISOLANTE ACCIAIO INOSSIDABILE NERO OPACO 0,35L EVA

UV1	UV2	IMBALLO
1	6	1/6/24 PB



8 0 0 4 5 3 7 6 0 5 2 4 2



ART	BARCODE	ST.	PREZZO
06 05 25*	8004537605259		8,95

BOTTIGLIA ISOLANTE ACCIAIO INOSSID. NERO OPACO 0,5L EVA

UV1	UV2	IMBALLO
1	6	1/6/24 PB



8 0 0 4 5 3 7 6 0 5 2 5 9



ART	BARCODE	ST.	PREZZO
06 05 26*	8004537605266		11,70

BOTTIGLIA ISOLANTE ACCIAIO INOSSID. NERO OPACO 0,75L EVA

UV1	UV2	IMBALLO
1	6	1/6/24 PB



8 0 0 4 5 3 7 6 0 5 2 6 6



ART	BARCODE	ST.	PREZZO
06 03 41	8004537603415		7,70

BOTTIGLIA ISOLANTE BLU OPACO + TAPPO A VITE 0,35 L EVA

UV1	UV2	IMBALLO
1	6	1/6/24 PB



8 0 0 4 5 3 7 6 0 3 4 1 5



ART	BARCODE	ST.	PREZZO
06 03 42	8004537603422		8,00

BOTTIGLIA ISOLANTE BLU OPACO + TAPPO A VITE 0,50 L EVA

UV1	UV2	IMBALLO
1	6	1/6/24 PB



8 0 0 4 5 3 7 6 0 3 4 2 2



ART	BARCODE	ST.	PREZZO
06 03 43	8004537603439		10,20

BOTTIGLIA ISOLANTE BLU OPACO + TAPPO A VITE 0,75 L EVA

UV1	UV2	IMBALLO
1	6	1/6/24 PB



8 0 0 4 5 3 7 6 0 3 4 3 9



ART	BARCODE	ST.	PREZZO
06 03 44	8004537603446		11,60

BOTTIGLIA ISOLANTE BLU OPACO + TAPPO A VITE 1,00 L EVA

UV1	UV2	IMBALLO
1	6	1/6/24 PB



8 0 0 4 5 3 7 6 0 3 4 4 6



ART	BARCODE	ST.	PREZZO
06 04 27	4007389403589	H	9,20

BOTTIGLIA ISOLANTE MOD. 40 ORO 3/4 L ROTPUNKT

UV1	UV2	IMBALLO
1	6	1/6 BK



4 0 0 7 3 8 9 4 0 3 5 8 9



ART	BARCODE	ST.	PREZZO
06 04 28	4007389403602	H	10,75

BOTTIGLIA ISOLANTE MOD. 40 ARANCIONE 3/4 L ROTPUNKT

UV1	UV2	IMBALLO
1	6	1/6 BK



4 0 0 7 3 8 9 4 0 3 6 0 2



ART	BARCODE	ST.	PREZZO
06 03 01	8004537603019	H	6,25

BOTTIGLIA ISOLANTE COLORI ASSORTITI FROSTED 1/8 L EVA

UV1	UV2	IMBALLO
1	6	1/6/48 HT



8 0 0 4 5 3 7 6 0 3 0 1 9



ART	BARCODE	ST.	PREZZO
06 03 05	8004537603057	H	8,95

BOTTIGLIA ISOLANTE COLORI ASSORTITI FROSTED 1.0 L EVA

UV1	UV2	IMBALLO
1	6	1/6/24 HT



8 0 0 4 5 3 7 6 0 3 0 5 7



ART	BARCODE	ST.	PREZZO
06 04 31	4007389403503	H	10,75

BOTTIGLIA ISOLANTE MOD. 40 GIALLO 3/4 L ROTPUNKT

UV1	UV2	IMBALLO
1	6	1/6 BK



4 0 0 7 3 8 9 4 0 3 5 0 3



ART	BARCODE	ST.	PREZZO
06 04 32	4007389403848	H	10,75

BOTTIGLIA ISOLANTE MOD. 40 VERDE 3/4 L ROTPUNKT

UV1	UV2	IMBALLO
1	6	1/6 BK



4 0 0 7 3 8 9 4 0 3 8 4 8



ART	BARCODE	ST.	PREZZO
06 04 37	4007389404500	H	13,50

BOTTIGLIA ISOLANTE MOD. 40 GIALLO 1 L ROTPUNKT

UV1	UV2	IMBALLO
1	6	1/6 BK



4 0 0 7 3 8 9 4 0 4 5 0 0



ART	BARCODE	ST.	PREZZO
06 04 38	4007389404845	H	13,50

BOTTIGLIA ISOLANTE MOD. 40 VERDE 1 L ROTPUNKT

UV1	UV2	IMBALLO
1	6	1/6 BK



4 0 0 7 3 8 9 4 0 4 8 4 5



ART	BARCODE	ST.	PREZZO
06 03 11	8004537603118		11,90

BOTTIGLIA ISOLANTE NERO OPACO+TAPPO AUTOMATICO 450ML EVA

UV1	UV2	IMBALLO
1	3	1/3/24 HT



8 0 0 4 5 3 7 6 0 3 1 1 8



ART	BARCODE	ST.	PREZZO
06 03 12	8004537603125		11,90

BOTTIGLIA ISOLANTE BIANCO OPACO+TAPPO AUTOMATICO 450ML EVA

UV1	UV2	IMBALLO
1	3	1/3/24 HT



8 0 0 4 5 3 7 6 0 3 1 2 5



ART	BARCODE	ST.	PREZZO
06 03 13	8004537603132		11,90

BOTTIGLIA ISOLANTE GRIGIO OPACO+TAPPO AUTOMATICO 450ML EVA

UV1	UV2	IMBALLO
1	3	1/3/24 HT



8 0 0 4 5 3 7 6 0 3 1 3 2



ART	BARCODE	ST.	PREZZO
06 03 14	8004537603149		11,90

BOTTIGLIA ISOLANTE VIOLA OPACO+TAPPO AUTOMATICO 450ML EVA

UV1	UV2	IMBALLO
1	3	1/3/24 HT



8 0 0 4 5 3 7 6 0 3 1 4 9



ART	BARCODE	ST.	PREZZO
06 03 15	8004537603156		11,90

**BOTTIGLIA ISOLANTE BLU
OPACO+TAPPO AUTOMATICO 450ML EVA**

UV1	UV2	IMBALLO
1	3	1/3/24 HT



8 0 0 4 5 3 7 6 0 3 1 5 6



ART	BARCODE	ST.	PREZZO
06 03 16	8004537603163		11,90

**BOTTIGLIA ISOLANTE GIALLO
OPACO+TAPPO AUTOMATICO 450ML EVA**

UV1	UV2	IMBALLO
1	3	1/3/24 HT



8 0 0 4 5 3 7 6 0 3 1 6 3



ART	BARCODE	ST.	PREZZO
06 03 17	8004537603170		11,90

**BOTTIGLIA ISOLANTE VERDE
OPACO+TAPPO AUTOMATICO 450ML EVA**

UV1	UV2	IMBALLO
1	3	1/3/24 HT



8 0 0 4 5 3 7 6 0 3 1 7 0



ART	BARCODE	ST.	PREZZO
06 03 18	8004537603187		11,90

**BOTTIGLIA ISOLANTE CELESTE
OPACO+TAPPO AUTOMATICO 450ML EVA**

UV1	UV2	IMBALLO
1	3	1/3/24 HT



8 0 0 4 5 3 7 6 0 3 1 8 7



ART	BARCODE	ST.	PREZZO
06 03 19	8004537603194		11,90

**BOTTIGLIA ISOLANTE PETROLIO
OPACO+TAPPO AUTOMATICO 450ML EVA**

UV1	UV2	IMBALLO
1	3	1/3/24 HT



8 0 0 4 5 3 7 6 0 3 1 9 4



ART	BARCODE	ST.	PREZZO
06 03 20	8004537603200		11,90

**BOTTIGLIA ISOLANTE ROSA
CORALLO+TAPPO AUTOMATICO 450ML
EVA**

UV1	UV2	IMBALLO
1	3	1/3/24 HT



8 0 0 4 5 3 7 6 0 3 2 0 0



ART	BARCODE	ST.	PREZZO
06 03 21	8004537603217		11,90

**BOTTIGLIA ISOLANTE ROSA BABY
OPACO+TAPPO AUTOMAT 450ML EVA**

UV1	UV2	IMBALLO
1	3	1/3/24 HT



8 0 0 4 5 3 7 6 0 3 2 1 7



ART	BARCODE	ST.	PREZZO
06 04 50*	4007389405439	A	8,80

**BOTTIGLIA ISOLANTE MOD. 40
BIANCO/PINK 1/8 L ROTPUNKT**

UV1	UV2	IMBALLO
1	6	1/6 BK



4 0 0 7 3 8 9 4 0 5 4 3 9



ART	BARCODE	ST.	PREZZO
06 04 51*	4007389405866		9,10

**BOTTIGLIA ISOLANTE MOD. 40
BIANCO/VERDE 1/8 L ROTPUNKT**

UV1	UV2	IMBALLO
1	6	1/6 BK



4 0 0 7 3 8 9 4 0 5 8 6 6



ART	BARCODE	ST.	PREZZO
06 04 52*	4007389405514	A	8,80

**BOTTIGLIA ISOLANTE MOD. 40
BIANCO/GIALLO 1/8 L ROTPUNKT**

UV1	UV2	IMBALLO
1	6	1/6 BK



4 0 0 7 3 8 9 4 0 5 5 1 4



ART	BARCODE	ST.	PREZZO
06 04 53*	4007389405651		9,10

**BOTTIGLIA ISOLANTE MOD. 40
BIANCO/ARANCIO 1/8 L ROTPUNKT**

UV1	UV2	IMBALLO
1	6	1/6 BK



4 0 0 7 3 8 9 4 0 5 6 5 1



ART	BARCODE	ST.	PREZZO
06 04 54*	4007389405811		9,10

**BOTTIGLIA ISOLANTE MOD. 40
BIANCO/BLU 1/8 L ROTPUNKT**

UV1	UV2	IMBALLO
1	6	1/6 BK



4 0 0 7 3 8 9 4 0 5 8 1 1



ART	BARCODE	ST.	PREZZO
06 04 55	4007389405750		9,10

BOTTIGLIA ISOLANTE MOD. 40
BIANCO/ROSSO 1/8 L ROTPUNKT

UV1	UV2	IMBALLO
1	6	1/6 BK



4 0 0 7 3 8 9 4 0 5 7 5 0



ART	BARCODE	ST.	PREZZO
06 04 56	4007389411430	A	9,40

BOTTIGLIA ISOLANTE MOD. 40
BIANCO/PINK 1/4 L ROTPUNKT

UV1	UV2	IMBALLO
1	6	1/6 BK



4 0 0 7 3 8 9 4 1 1 4 3 0



ART	BARCODE	ST.	PREZZO
06 04 57	4007389411867		9,70

BOTTIGLIA ISOLANTE MOD. 40
BIANCO/VERDE 1/4 L ROTPUNKT

UV1	UV2	IMBALLO
1	6	1/6 BK



4 0 0 7 3 8 9 4 1 1 8 6 7



ART	BARCODE	ST.	PREZZO
06 04 58	4007389411515	A	9,40

BOTTIGLIA ISOLANTE MOD. 40
BIANCO/GIALLO 1/4 L ROTPUNKT

UV1	UV2	IMBALLO
1	6	1/6 BK



4 0 0 7 3 8 9 4 1 1 5 1 5



ART	BARCODE	ST.	PREZZO
06 04 59	4007389411652		9,70

BOTTIGLIA ISOLANTE MOD. 40
BIANCO/ARANCIO 1/4 L ROTPUNKT

UV1	UV2	IMBALLO
1	6	1/6 BK



4 0 0 7 3 8 9 4 1 1 6 5 2



ART	BARCODE	ST.	PREZZO
06 04 60	4007389411812		9,70

BOTTIGLIA ISOLANTE MOD. 40
BIANCO/BLU 1/4 L ROTPUNKT

UV1	UV2	IMBALLO
1	6	1/6 BK



4 0 0 7 3 8 9 4 1 1 8 1 2



ART	BARCODE	ST.	PREZZO
06 04 61	4007389411751		9,70

BOTTIGLIA ISOLANTE MOD. 40
BIANCO/ROSSO 1/4 L ROTPUNKT

UV1	UV2	IMBALLO
1	6	1/6 BK



4 0 0 7 3 8 9 4 1 1 7 5 1



ART	BARCODE	ST.	PREZZO
06 04 62	4007389412437	A	10,00

BOTTIGLIA ISOLANTE MOD. 40
BIANCO/PINK 1/2 L ROTPUNKT

UV1	UV2	IMBALLO
1	6	1/6 BK



4 0 0 7 3 8 9 4 1 2 4 3 7



ART	BARCODE	ST.	PREZZO
06 04 63	4007389412864		10,25

BOTTIGLIA ISOLANTE MOD. 40
BIANCO/VERDE 1/2 L ROTPUNKT

UV1	UV2	IMBALLO
1	6	1/6 BK



4 0 0 7 3 8 9 4 1 2 8 6 4



ART	BARCODE	ST.	PREZZO
06 04 64	4007389412512	A	10,00

BOTTIGLIA ISOLANTE MOD. 40
BIANCO/GIALLO 1/2 L ROTPUNKT

UV1	UV2	IMBALLO
1	6	1/6 BK



4 0 0 7 3 8 9 4 1 2 5 1 2



ART	BARCODE	ST.	PREZZO
06 04 65	4007389412659		10,25

BOTTIGLIA ISOLANTE MOD. 40
BIANCO/ARANCIO 1/2 L ROTPUNKT

UV1	UV2	IMBALLO
1	6	1/6 BK



4 0 0 7 3 8 9 4 1 2 6 5 9



ART	BARCODE	ST.	PREZZO
06 04 66	4007389412819		10,25

BOTTIGLIA ISOLANTE MOD. 40
BIANCO/BLU 1/2 L ROTPUNKT

UV1	UV2	IMBALLO
1	6	1/6 BK



4 0 0 7 3 8 9 4 1 2 8 1 9



ART	BARCODE	ST.	PREZZO
06 04 67*	4007389412758		10,25

BOTTIGLIA ISOLANTE MOD. 40
BIANCO/ROSSO 1/2 L ROTPUNKT

UV1	UV2	IMBALLO
1	6	1/6 BK



4 0 0 7 3 8 9 4 1 2 7 5 8



ART	BARCODE	ST.	PREZZO
06 04 68*	4007389413434	A	11,40

BOTTIGLIA ISOLANTE MOD. 40
BIANCO/PINK 3/4 L ROTPUNKT

UV1	UV2	IMBALLO
1	6	1/6 BK



4 0 0 7 3 8 9 4 1 3 4 3 4



ART	BARCODE	ST.	PREZZO
06 04 69*	4007389413861		11,75

BOTTIGLIA ISOLANTE MOD. 40
BIANCO/VERDE 3/4 L ROTPUNKT

UV1	UV2	IMBALLO
1	6	1/6 BK



4 0 0 7 3 8 9 4 1 3 8 6 1



ART	BARCODE	ST.	PREZZO
06 04 70*	4007389413519	A	11,40

BOTTIGLIA ISOLANTE MOD. 40
BIANCO/GIALLO 3/4 L ROTPUNKT

UV1	UV2	IMBALLO
1	6	1/6 BK



4 0 0 7 3 8 9 4 1 3 5 1 9



ART	BARCODE	ST.	PREZZO
06 04 71*	4007389413656		11,75

BOTTIGLIA ISOLANTE MOD. 40
BIANCO/ARANCIO 3/4 L ROTPUNKT

UV1	UV2	IMBALLO
1	6	1/6 BK



4 0 0 7 3 8 9 4 1 3 6 5 6



ART	BARCODE	ST.	PREZZO
06 04 72*	4007389413816		11,75

BOTTIGLIA ISOLANTE MOD. 40
BIANCO/BLU 3/4 L ROTPUNKT

UV1	UV2	IMBALLO
1	6	1/6 BK



4 0 0 7 3 8 9 4 1 3 8 1 6



ART	BARCODE	ST.	PREZZO
06 04 73*	4007389413755		11,75

BOTTIGLIA ISOLANTE MOD. 40
BIANCO/ROSSO 3/4 L ROTPUNKT

UV1	UV2	IMBALLO
1	6	1/6 BK



4 0 0 7 3 8 9 4 1 3 7 5 5



ART	BARCODE	ST.	PREZZO
06 04 74*	4007389414431	A	14,20

BOTTIGLIA ISOLANTE MOD. 40
BIANCO/PINK 1 L ROTPUNKT

UV1	UV2	IMBALLO
1	6	1/6 BK



4 0 0 7 3 8 9 4 1 4 4 3 1



ART	BARCODE	ST.	PREZZO
06 04 75*	4007389414868		14,20

BOTTIGLIA ISOLANTE MOD. 40
BIANCO/VERDE 1 L ROTPUNKT

UV1	UV2	IMBALLO
1	6	1/6 BK



4 0 0 7 3 8 9 4 1 4 8 6 8



ART	BARCODE	ST.	PREZZO
06 04 76*	4007389414516	A	14,20

BOTTIGLIA ISOLANTE MOD. 40
BIANCO/GIALLO 1 L ROTPUNKT

UV1	UV2	IMBALLO
1	6	1/6 BK



4 0 0 7 3 8 9 4 1 4 5 1 6



ART	BARCODE	ST.	PREZZO
06 04 77*	4007389414653		14,20

BOTTIGLIA ISOLANTE MOD. 40
BIANCO/ARANCIO 1 L ROTPUNKT

UV1	UV2	IMBALLO
1	6	1/6 BK



4 0 0 7 3 8 9 4 1 4 6 5 3



ART	BARCODE	ST.	PREZZO
06 04 78*	4007389414813		14,20

BOTTIGLIA ISOLANTE MOD. 40
BIANCO/BLU 1 L ROTPUNKT

UV1	UV2	IMBALLO
1	6	1/6 BK



4 0 0 7 3 8 9 4 1 4 8 1 3



ART	BARCODE	ST.	PREZZO
06 04 79	4007389414752		14,20

BOTTIGLIA ISOLANTE MOD. 40
BIANCO/ROSSO 1 L ROTPUNKT

UV1	UV2	IMBALLO
1	6	1/6 BK



4 0 0 7 3 8 9 4 1 4 7 5 2



ART	BARCODE	ST.	PREZZO
06 10 41	8004537610413		13,20

CARAFFA ISOLANTE "PUNTI" 1,9 L EVA

UV1	UV2	IMBALLO
1	8	1/8 PG



8 0 0 4 5 3 7 6 1 0 4 1 3



ART	BARCODE	ST.	PREZZO
06 10 49	8004537610499		15,25

AIRPOT ACCIAIO INOSSIDABILE 1,9L EVA

UV1	UV2	IMBALLO
1	8	1/8 PG



8 0 0 4 5 3 7 6 1 0 4 9 9



ART	BARCODE	ST.	PREZZO
06 10 55	8004537610550		32,00

AIRPOT 'TOKIO' ACCIAIO INOSSIDABILE
2,5L EVA

UV1	UV2	IMBALLO
1	6	1/6 PB



8 0 0 4 5 3 7 6 1 0 5 5 0



ART	BARCODE	ST.	PREZZO
06 10 56	8004537610567		35,00

AIRPOT 'TOKIO' ACCIAIO INOSSIDABILE
3,0L EVA

UV1	UV2	IMBALLO
1	6	1/6 PB



8 0 0 4 5 3 7 6 1 0 5 6 7



ART	BARCODE	ST.	PREZZO
06 10 57	8004537610574		43,00

AIRPOT 'TOKIO' ACCIAIO INOSSIDABILE
4,0L EVA

UV1	UV2	IMBALLO
1	6	1/6 PB



8 0 0 4 5 3 7 6 1 0 5 7 4



ART	BARCODE	ST.	PREZZO
06 10 69	8004537610697		35,00

CONTENITORE ISOLANTE ACCIAIO
INOSSIDABILE 6L EVA

UV1	UV2	IMBALLO
1	6	1/6 PB



8 0 0 4 5 3 7 6 1 0 6 9 7



ART	BARCODE	ST.	PREZZO
06 10 70	8004537610703		42,00

CONTENITORE ISOLANTE ACCIAIO
INOSSIDABILE 9,5L EVA

UV1	UV2	IMBALLO
1	6	1/6 PB



8 0 0 4 5 3 7 6 1 0 7 0 3



ART	BARCODE	ST.	PREZZO
06 08 82	8004537608823		20,50

CARAFFA ISOLANTE ACCIAIO
INOSSIDABILE 1L EVA

UV1	UV2	IMBALLO
1	6	1/6 PB



8 0 0 4 5 3 7 6 0 8 8 2 3



ART	BARCODE	ST.	PREZZO
06 08 83	8004537608830		23,00

CARAFFA ISOLANTE ACCIAIO
INOSSIDABILE 1,5L EVA

UV1	UV2	IMBALLO
1	6	1/6 PB



8 0 0 4 5 3 7 6 0 8 8 3 0



ART	BARCODE	ST.	PREZZO
06 08 84	8004537608847		24,20

CARAFFA ISOLANTE ACCIAIO
INOSSIDABILE 2L EVA

UV1	UV2	IMBALLO
1	6	1/6 PB



8 0 0 4 5 3 7 6 0 8 8 4 7



ART	BARCODE	ST.	PREZZO
06 08 56	8004537608564		21,00

CARAFFA ISOLANTE ACCIAIO
INOSSIDABILE 1L EVA

UV1	UV2	IMBALLO
1	6	1/6 PB



8 0 0 4 5 3 7 6 0 8 5 6 4



ART	BARCODE	ST.	PREZZO
06 08 57	8004537608571		22,50

CARAFFA ISOLANTE ACCIAIO
INOSSIDABILE 1,5L EVA

UV1	UV2	IMBALLO
1	6	1/6 PB



8 0 0 4 5 3 7 6 0 8 5 7 1



ART	BARCODE	ST.	PREZZO
06 08 58	8004537608588		24,00

CARAFFA ISOLANTE ACCIAIO
INOSSIDABILE 2L EVA

UV1	UV2	IMBALLO
1	6	1/6 PB



8 0 0 4 5 3 7 6 0 8 5 8 8



ART	BARCODE	ST.	PREZZO
06 01 01*	8004537601015	H	37,50

CARAFFA ISOLANTE DOPPIA PARETE
ACCIAIO INOX 0,70L EVA

UV1	UV2	IMBALLO
1	6	1/12 PB



8 0 0 4 5 3 7 6 0 1 0 1 5



ART	BARCODE	ST.	PREZZO
06 01 02*	8004537601022	H	39,50

CARAFFA ISOLANTE DOPPIA PARETE
ACCIAIO INOX 1,00L EVA

UV1	UV2	IMBALLO
1	6	1/12 PB



8 0 0 4 5 3 7 6 0 1 0 2 2



ART	BARCODE	ST.	PREZZO
06 01 03*	8004537601039	H	43,50

CARAFFA ISOLANTE DOPPIA PARETE
ACCIAIO INOX 1,50L EVA

UV1	UV2	IMBALLO
1	6	1/12 PB



8 0 0 4 5 3 7 6 0 1 0 3 9



ART	BARCODE	ST.	PREZZO
06 01 11	8004537601114		22,50

CARAFFA ISOLANTE DOPPIA PARETE
ACCIAIO INOX 1,00L EVA

UV1	UV2	IMBALLO
1	12	1/12 PB



8 0 0 4 5 3 7 6 0 1 1 1 4



ART	BARCODE	ST.	PREZZO
06 01 12	8004537601121		25,00

CARAFFA ISOLANTE DOPPIA PARETE
ACCIAIO INOX 1,50L EVA

UV1	UV2	IMBALLO
1	12	1/12 PB



8 0 0 4 5 3 7 6 0 1 1 2 1



ART	BARCODE	ST.	PREZZO
06 01 13	8004537601138		27,50

CARAFFA ISOLANTE DOPPIA PARETE
ACCIAIO INOX 2,00L EVA

UV1	UV2	IMBALLO
1	12	1/12 PB



8 0 0 4 5 3 7 6 0 1 1 3 8



ART	BARCODE	ST.	PREZZO
06 01 15	8004537601152		29,50

CARAFFA ISOLANTE DOPPIA PARETE
ACCIAIO INOX 1,00L EVA

UV1	UV2	IMBALLO
1	12	1/12 PB



8 0 0 4 5 3 7 6 0 1 1 5 2



ART	BARCODE	ST.	PREZZO
06 01 16	8004537601169		31,50

CARAFFA ISOLANTE DOPPIA PARETE
ACCIAIO INOX 1,30L EVA

UV1	UV2	IMBALLO
1	12	1/12 PB



8 0 0 4 5 3 7 6 0 1 1 6 9



ART	BARCODE	ST.	PREZZO
06 09 26	4007389220933	A	15,90

CARAFFA ISOLANTE 220 BIANCO/BLU 1,0
L ROTPUNKT

UV1	UV2	IMBALLO
1	6	1/6 BK



4 0 0 7 3 8 9 2 2 0 9 3 3



ART	BARCODE	ST.	PREZZO
06 10 25	8004537610253	A	17,80

CARAFFA ISOLANTE BIANCO LUCIDO 1,0
L EVA

UV1	UV2	IMBALLO
1	6	1/6/12 HT



8 0 0 4 5 3 7 6 1 0 2 5 3



ART	BARCODE	ST.	PREZZO
06 10 26	8004537610260	A	17,80

CARAFFA ISOLANTE ROSSO BORDEAUX OPACO 1,0 L EVA

UV1	UV2	IMBALLO
1	6	1/6/12 HT



8 0 0 4 5 3 7 6 1 0 2 6 0



ART	BARCODE	ST.	PREZZO
06 10 27	8004537610277	A	17,80

CARAFFA ISOLANTE NERO OPACO 1,0 L EVA

UV1	UV2	IMBALLO
1	6	1/6/12 HT



8 0 0 4 5 3 7 6 1 0 2 7 7



ART	BARCODE	ST.	PREZZO
06 10 20	8004537610208	A	11,50

CARAFFA ISOLANTE BIANCO AVORIO 1,0 L EVA

UV1	UV2	IMBALLO
1	6	1/6 HT



8 0 0 4 5 3 7 6 1 0 2 0 8



ART	BARCODE	ST.	PREZZO
12 22 38	8033237337559		14,90

CARAFFA ISOLANTE BIANCO LUCIDO 1,0 L FOREVER

UV1	UV2	IMBALLO
1	12	1/12 LB



8 0 3 3 2 3 7 3 3 7 5 5 9



ART	BARCODE	ST.	PREZZO
12 22 39	8033237337566		14,90

CARAFFA ISOLANTE NERO OPACO 1,0 L FOREVER

UV1	UV2	IMBALLO
1	12	1/12 LB



8 0 3 3 2 3 7 3 3 7 5 6 6



ART	BARCODE	ST.	PREZZO
06 10 31	8004537610314	A	13,50

CARAFFA ISOLANTE BIANCO LUCIDO 1,0 L EVA

UV1	UV2	IMBALLO
1	6	1/6/12 HT



8 0 0 4 5 3 7 6 1 0 3 1 4



ART	BARCODE	ST.	PREZZO
06 10 32	8004537610321	A	13,50

CARAFFA ISOLANTE ROSSO LUCIDO 1,0 L EVA

UV1	UV2	IMBALLO
1	6	1/6/12 HT



8 0 0 4 5 3 7 6 1 0 3 2 1



ART	BARCODE	ST.	PREZZO
06 10 34	8004537610345	A	13,50

CARAFFA ISOLANTE NERO OPACO 1,0 L EVA

UV1	UV2	IMBALLO
1	6	1/6/12 HT



8 0 0 4 5 3 7 6 1 0 3 4 5



ART	BARCODE	ST.	PREZZO
06 10 33	8004537610338	A	13,50

CARAFFA ISOLANTE BLU OPACO 1,0 L EVA

UV1	UV2	IMBALLO
1	6	1/6/12 HT



8 0 0 4 5 3 7 6 1 0 3 3 8

Arredobagno



ART	BARCODE	ST.	PREZZO
04 45 18	9001629750506		4,90

STURALAVANDINO 14,5 X 51 CM MASTA

UV1	UV2	IMBALLO
1	10	1/10/40 BK



9 0 0 1 6 2 9 7 5 0 5 0 6



ART	BARCODE	ST.	PREZZO
04 80 56	8004537480566		6,25

PORTASCOPINO ACCIAIO INOSSIDABILE "LIDO" 40CM EVA

UV1	UV2	IMBALLO
1	6	1/24 PB



8 0 0 4 5 3 7 4 8 0 5 6 6



ART	BARCODE	ST.	PREZZO
04 80 55	8004537480559	A	12,50

PORTASCOPINO ACCIAIO INOX SATINATO 40,5CM EVA

UV1	UV2	IMBALLO
1	12	1/12 PB



8 0 0 4 5 3 7 4 8 0 5 5 9



ART	BARCODE	ST.	PREZZO
04 80 59	8004537480597		16,30

PORTASCOPINO+ROTOLO CROMATI 65CM EVA

UV1	UV2	IMBALLO
1	6	1/6 PB



8 0 0 4 5 3 7 4 8 0 5 9 7



ART	BARCODE	ST.	PREZZO
04 80 13	8004537480139		20,90

PORTASCOPINO+ROTOLO CROMATI 82 CM EVA

UV1	UV2	IMBALLO
1	4	1/4 PB



8 0 0 4 5 3 7 4 8 0 1 3 9



ART	BARCODE	ST.	PREZZO
04 45 35	9001629751657		4,25

PORTASCOPINO BIANCO "918" 11,5X37 CM MASTA

UV1	UV2	IMBALLO
1	10	1/10 SP



9 0 0 1 6 2 9 7 5 1 6 5 7



ART	BARCODE	ST.	PREZZO
04 45 41	8011887000924		1,55

RICAMBIO SCOPINO BIANCO 37CM Ø 7CM

UV1	UV2	IMBALLO
1	12	1/24 BK



8 0 1 1 8 8 7 0 0 0 9 2 4



ART	BARCODE	ST.	PREZZO
04 80 49	8004537480498	A	3,50

RICAMBIO SCOPINO BIANCO 048368 EVA

UV1	UV2	IMBALLO
1	6	1/60 PG



8 0 0 4 5 3 7 4 8 0 4 9 8



ART	BARCODE	ST.	PREZZO
04 80 54	8004537480542		3,50

RICAMBIO SCOPINO BIANCO EVA

UV1	UV2	IMBALLO
1	6	1/60 PG



8 0 0 4 5 3 7 4 8 0 5 4 2



ART	BARCODE	ST.	PREZZO
04 80 61	8004537480610		20,90

PORTASCIUGAMANI CROMATO 94CM EVA

UV1	UV2	IMBALLO
1	4	1/4 PB



8 0 0 4 5 3 7 4 8 0 6 1 0



ART	BARCODE	ST.	PREZZO
04 83 25*	8004537483253	H	3,90

PORTA ASCIUGAMANO+VENTOSA ADRIA EVA

UV1	UV2	IMBALLO
1	6	1/6/36 HT



8 0 0 4 5 3 7 4 8 3 2 5 3



ART	BARCODE	ST.	PREZZO
04 80 95	8004537480955	A	14,80

SPECCHIO BAGNO TELESCOPICO CROMATO 17CM EVA

UV1	UV2	IMBALLO
1	6	1/12 PB



8 0 0 4 5 3 7 4 8 0 9 5 5



ART	BARCODE	ST.	PREZZO
04 36 51	4005643206143	H	15,00

PORTA-SAPONE CON VENTOSA 'HOOKIE' 12,5X9X10,5CM GSW

UV1	UV2	IMBALLO
1	12	1/12/96 BC



4 0 0 5 6 4 3 2 0 6 1 4 3



ART	BARCODE	ST.	PREZZO
04 80 20	8004537480207	H	29,70

CARRELLO 3 PIANI CROMATO 40X32X75 CM EVA

UV1	UV2	IMBALLO
1	4	1/4 LB



8 0 0 4 5 3 7 4 8 0 2 0 7



ART	BARCODE	ST.	PREZZO
04 83 59	8004537483598	H	5,50

BICCHIERE BAGNO ACRILICO 'CERVIA' 9CM EVA

UV1	UV2	IMBALLO
1	4	1/4/80 BK



8 0 0 4 5 3 7 4 8 3 5 9 8



ART	BARCODE	ST.	PREZZO
04 83 68	8004537483680	A	5,80

PORTASCOPINO PLASTICA 'RICCIONE' 37CM EVA

UV1	UV2	IMBALLO
1	6	1/6/48 BK



8 0 0 4 5 3 7 4 8 3 6 8 0



ART	BARCODE	ST.	PREZZO
04 84 21	8004537484212	H	9,90

PORTASAPONE BLACK 'PORTO CERVO' EVA

UV1	UV2	IMBALLO
1	6	1/48 PB



8 0 0 4 5 3 7 4 8 4 2 1 2



ART	BARCODE	ST.	PREZZO
04 84 33	8004537484335	H	8,95

PORTA-SAPONE 'PORTOFINO' ACCIAIO INOSSIDABILE EVA

UV1	UV2	IMBALLO
1	12	1/72 PB



8 0 0 4 5 3 7 4 8 4 3 3 5



ART	BARCODE	ST.	PREZZO
04 24 32	8011887301168		6,25

TAPPETINO DOCCIA BIANCO 52X52CM

UV1	UV2	IMBALLO
1	12	1/12 PH



8 0 1 1 8 8 7 3 0 1 1 6 8



ART	BARCODE	ST.	PREZZO
04 24 31	8011887301151		6,25

TAPPETINO VASCA BIANCO 72X36CM

UV1	UV2	IMBALLO
1	12	1/12 PH



8 0 1 1 8 8 7 3 0 1 1 5 1



ART	BARCODE	ST.	PREZZO
04 47 73	9002427450025	A	3,95

TAPPETINO PER LAVELLO BIANCO Ø 29.5 CM TEKO PLASTIC

UV1	UV2	IMBALLO
1	10	1/50 PG



9 0 0 2 4 2 7 4 5 0 0 2 5

Biancheria Appendiabiti Stirare



ART	BARCODE	ST.	PREZZO
04 24 23	4007267816531		3,05

SPRUZZABIANCHIERIA COLORI ASSORTITI 0,50 L SANTEX

UV1	UV2	IMBALLO
1	10	1/20 BK



4 0 0 7 2 6 7 8 1 6 5 3 1



ART	BARCODE	ST.	PREZZO
04 36 34	4007267817002		5,25

RETE BIANCHERIA DA KG 3 kg 50X70CM SANTEX

UV1	UV2	IMBALLO
1	5	1/10 PH



4 0 0 7 2 6 7 8 1 7 0 0 2



ART	BARCODE	ST.	PREZZO
04 36 35	4007267817026		4,50

RETE BIANCHERIA 25x45CM 1KG SANTEX

UV1	UV2	IMBALLO
1	5	1/10 PG



4 0 0 7 2 6 7 8 1 7 0 2 6



ART	BARCODE	ST.	PREZZO
04 24 69	4006501853592		97,50

STENDIBIANCHERIA 'LINOLIFT 500' ALLUMINIO LEIFHEIT

UV1	UV2	IMBALLO
1	2	1/3 SP



4 0 0 6 5 0 1 8 5 3 5 9 2



ART	BARCODE	ST.	PREZZO
04 20 51	4006501832016	A	35,00

STENDIBIANCHERIA TELEGANT DELUXE 70CM LEIFHEIT

UV1	UV2	IMBALLO
1	2	1/4 HB



4 0 0 6 5 0 1 8 3 2 0 1 6



ART	BARCODE	ST.	PREZZO
04 20 52	4006501831002		41,00

STENDIBIANCHERIA TELEGANT DELUXE 100CM LEIFHEIT

UV1	UV2	IMBALLO
1	2	1/4 HB



4 0 0 6 5 0 1 8 3 1 0 0 2



ART	BARCODE	ST.	PREZZO
04 20 34	4006501451101		8,20

APPENDIABITI AIRETTE 26CM LEIFHEIT

UV1	UV2	IMBALLO
1	6	1/6/60 HB



4 0 0 6 5 0 1 4 5 1 1 0 1



ART	BARCODE	ST.	PREZZO
04 47 03	9001629540305		2,25

FILO PER BUCATO PLASTICA 3MM INTERNO PP 20M MASTA

UV1	UV2	IMBALLO
1	12	1/10 SL



9 0 0 1 6 2 9 5 4 0 3 0 5



ART	BARCODE	ST.	PREZZO
04 47 05	9001404300506		3,50

50 PEZZI MOLLETTE BIANCHERIA LEGNO

UV1	UV2	IMBALLO
1	10	1/20 SP



9 0 0 1 4 0 4 3 0 0 5 0 6



ART	BARCODE	ST.	PREZZO
04 47 06	9001629540015		2,40

20 MOLLETTE BUCATO PP EXTRA STRONG MASTA

UV1	UV2	IMBALLO
1	10	1/10/30 SP



9 0 0 1 6 2 9 5 4 0 0 1 5



ART	BARCODE	ST.	PREZZO
04 25 63	7610859153661	A	6,70

PORTADERSIVO+COP.'POWDY' TRASP.7L 23,5X19,5X25,5 CM ROTHO

UV1	UV2	IMBALLO
1	6	1/6 AL



7 6 1 0 8 5 9 1 5 3 6 6 1



ART	BARCODE	ST.	PREZZO
04 24 22	4013291450603		1,35

SPRUZZABIANCHIERIA PLASTICA 0,35 L WUELLNER

UV1	UV2	IMBALLO
1	10	1/30 BK



4 0 1 3 2 9 1 4 5 0 6 0 3



ART	BARCODE	ST.	PREZZO
04 28 80	4007267816470		17,40

TOVAGLIA STIRO 125X75CM SANTEX

UV1	UV2	IMBALLO
1	10	1/10 PH



4 0 0 7 2 6 7 8 1 6 4 7 0



ART	BARCODE	ST.	PREZZO
04 28 79	4007267816500		7,85

IMBOTTITURA FODERA ASSE DA STIRO MOLTON 140X40CM SANTEX

UV1	UV2	IMBALLO
1	5	1/5 PH



4 0 0 7 2 6 7 8 1 6 5 0 0



ART	BARCODE	ST.	PREZZO
04 28 86	4007267816067		10,00

FODERA ASSE DA STIRO COTONE 127X45CM SANTEX

UV1	UV2	IMBALLO
1	5	1/5 PH



4 0 0 7 2 6 7 8 1 6 0 6 7



ART	BARCODE	ST.	PREZZO
04 28 85	4007267816456		11,95

FODERA ASSE DA STIRO COTONE 130X54CM SANTEX

UV1	UV2	IMBALLO
1	5	1/5 PH



4 0 0 7 2 6 7 8 1 6 4 5 6



ART	BARCODE	ST.	PREZZO
04 28 87	4007267816036		12,75

FODERA ASSE DA STIRO COTONE 140X60CM SANTEX

UV1	UV2	IMBALLO
1	5	1/5 PH



4 0 0 7 2 6 7 8 1 6 0 3 6



ART	BARCODE	ST.	PREZZO
04 29 31	8004537429312	A	5,50

2 APPENDIABITI ANTISCIVOLO 45CM EVA

UV1	UV2	IMBALLO
1	12	1/12/48 SL



8 0 0 4 5 3 7 4 2 9 3 1 2



ART	BARCODE	ST.	PREZZO
04 29 33	8004537429336	A	3,70

2 APPENDIABITI ANTISCIVOLO 40CM EVA

UV1	UV2	IMBALLO
1	12	1/12/72 SL



8 0 0 4 5 3 7 4 2 9 3 3 6

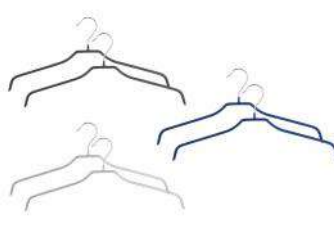

ART	BARCODE	ST.	PREZZO
04 29 36	8004537429367	A	3,95

2 APPENDICAMICIE ANTISCIVOLO 41CM EVA

UV1	UV2	IMBALLO
1	12	1/12/72 SL



8 0 0 4 5 3 7 4 2 9 3 6 7

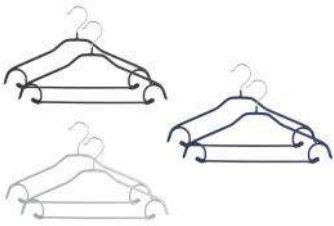

ART	BARCODE	ST.	PREZZO
04 29 37	8004537429374	H	3,95

2 APPENDI ABITI ANTISCIVOLO 38CM EVA

UV1	UV2	IMBALLO
1	12	1/12/72 SL



8 0 0 4 5 3 7 4 2 9 3 7 4

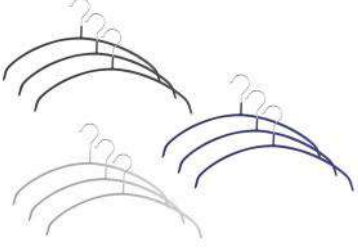

ART	BARCODE	ST.	PREZZO
04 29 38	8004537429381	H	4,75

3 APPENDI CAMICIE ANTISCIVOLO 41,5CM EVA

UV1	UV2	IMBALLO
1	12	1/12/48 SL



8 0 0 4 5 3 7 4 2 9 3 8 1

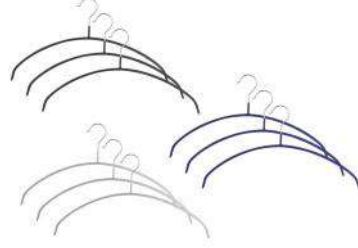

ART	BARCODE	ST.	PREZZO
04 29 39	8004537429398	H	4,15

3 APPENDI CAMICIE ANTISCIVOLO 42CM EVA

UV1	UV2	IMBALLO
1	12	1/12/48 SL



8 0 0 4 5 3 7 4 2 9 3 9 8



ART	BARCODE	ST.	PREZZO
04 29 44	8004537429442	A	3,95

2 2 APPENDICALZONI ANTISCIVOLO 35CM EVA

UV1	UV2	IMBALLO
1	12	1/12/72 SL



8 0 0 4 5 3 7 4 2 9 4 4 2



ART	BARCODE	ST.	PREZZO
04 29 72	8004537429725	A	4,75

3 APPENDIBITI LEGNO NATURALE 45CM EVA

UV1	UV2	IMBALLO
1	12	1/12/36 SL



8 0 0 4 5 3 7 4 2 9 7 2 5

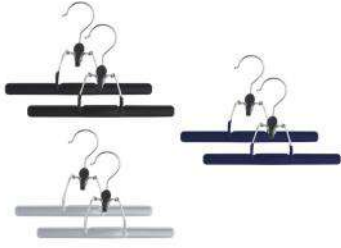

ART	BARCODE	ST.	PREZZO
04 29 41	8004537429411	A	5,20

2 APPENDIZIONI ANTISCIVOLO 26CM EVA

UV1	UV2	IMBALLO
1	12	1/12/48 SL



8 0 0 4 5 3 7 4 2 9 4 1 1



ART	BARCODE	ST.	PREZZO
04 29 42*	8004537429428	H	3,85

2 TENDICALZONI ANTISCIVOLO 31CM EVA

UV1	UV2	IMBALLO
1	12	1/12 SL



8 0 0 4 5 3 7 4 2 9 4 2 8



ART	BARCODE	ST.	PREZZO
04 29 51*	8004537429510	H	3,95

2 TENDIGONNE ANTISCIVOLO 50CM EVA

UV1	UV2	IMBALLO
1	12	1/12 SL



8 0 0 4 5 3 7 4 2 9 5 1 0

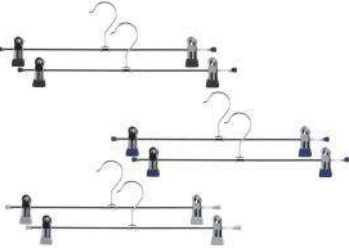

ART	BARCODE	ST.	PREZZO
04 29 53	8004537429534	A	3,85

2 APPENDINI CLIP ANTISCIVOLO 40CM EVA

UV1	UV2	IMBALLO
1	12	1/12/72 SL



8 0 0 4 5 3 7 4 2 9 5 3 4



ART	BARCODE	ST.	PREZZO
04 37 63	4000270669019		7,95

FORMA PER SCARPE LEGNO FSC 1 PAIO MIS. 39-41 KESPER

UV1	UV2	IMBALLO
1	4	1/4/40 PH



4 0 0 0 2 7 0 6 6 9 0 1 9



ART	BARCODE	ST.	PREZZO
04 37 64	4000270669026	A	7,95

FORMA PER SCARPE LEGNO FSC 1 PAIO MIS. 42-43 KESPER

UV1	UV2	IMBALLO
1	4	1/4/40 PH



4 0 0 0 2 7 0 6 6 9 0 2 6



ART	BARCODE	ST.	PREZZO
04 37 65	4000270669033		7,95

FORMA PER SCARPE LEGNO 1 PAIO MIS. 44-46 KESPER

UV1	UV2	IMBALLO
1	4	1/4/40 PH



4 0 0 0 2 7 0 6 6 9 0 3 3

Arredare Sistemare



ART	BARCODE	ST.	PREZZO
04 22 67	4009808232015		2,35

CESTINO 'TREND' PP 24X16 CM
BUCHSTEINER

UV1	UV2	IMBALLO
1	4	1/4/112 BK



4 0 0 9 8 0 8 2 3 2 0 1 5



ART	BARCODE	ST.	PREZZO
04 22 68	4009808315213		4,95

CESTINO 'TREND' PP 34X22 CM
BUCHSTEINER

UV1	UV2	IMBALLO
1	4	1/4 BK



4 0 0 9 8 0 8 3 1 5 2 1 3



ART	BARCODE	ST.	PREZZO
04 25 71	7610859071484		4,40

CONTEN.'CLEAR BOX LADY SHOE'
TRASPAR.PP 5L 33X19X11CM ROTHO

UV1	UV2	IMBALLO
1	6	1/6 AL



7 6 1 0 8 5 9 0 7 1 4 8 4



ART	BARCODE	ST.	PREZZO
04 25 72	3234534048963		7,20

CONTEN.'CLEAR BOX MEN
SHOE'TRASPAR.PP 10L 36X27X14CM
ROTHO

UV1	UV2	IMBALLO
1	6	1/6 AL



3 2 3 4 5 3 4 0 4 8 9 6 3



ART	BARCODE	ST.	PREZZO
04 25 73	7610859071477		9,70

CONTEN.'CLEAR BOX SWEATER'
TRASPAR.PP 18L 40X33X17CM ROTHO

UV1	UV2	IMBALLO
1	6	1/6 AL



7 6 1 0 8 5 9 0 7 1 4 7 7



ART	BARCODE	ST.	PREZZO
04 25 45	7610859172310	A	9,80

CONTENITORE+COPERCHIO 'EVO SAFE'
PP 11L 39X28X16CM ROTHO

UV1	UV2	IMBALLO
1	5	1/5 AL



7 6 1 0 8 5 9 1 7 2 3 1 0



ART	BARCODE	ST.	PREZZO
04 25 46	7610859172327	A	12,30

CONTENITORE+COPERCHIO 'EVO SAFE'
PP 15L 39X28X23CM ROTHO

UV1	UV2	IMBALLO
1	6	1/6 AL



7 6 1 0 8 5 9 1 7 2 3 2 7



ART	BARCODE	ST.	PREZZO
04 25 47	7610859172341		22,70

CONTENITORE+COPERCHIO 'EVO SAFE'
PP 44L 59X39,5X28CM ROTHO

UV1	UV2	IMBALLO
1	6	1/6 AL



7 6 1 0 8 5 9 1 7 2 3 4 1



ART	BARCODE	ST.	PREZZO
04 25 48	7610859172358		31,00

CONTENITORE+COP+ROTELLE 'EVO
SAFE' PP 65L 59X39,5X41CM ROTHO

UV1	UV2	IMBALLO
1	3	1/3 AL



7 6 1 0 8 5 9 1 7 2 3 5 8



ART	BARCODE	ST.	PREZZO
04 24 86	7610859169228		7,20

CESTO 'COUNTRY' A5 ANTRACITE PP 6L
28X18,5X12,6 CM ROTHO

UV1	UV2	IMBALLO
1	3	1/3 BK



7 6 1 0 8 5 9 1 6 9 2 2 8



ART	BARCODE	ST.	PREZZO
04 24 87	7610859124418		7,20

CESTO 'COUNTRY' A5 CAPPUCCINO PP
6L 28X18,5X12,6 CM ROTHO

UV1	UV2	IMBALLO
1	3	1/3 BK



7 6 1 0 8 5 9 1 2 4 4 1 8



ART	BARCODE	ST.	PREZZO
04 24 85	7610859123848		7,20

CESTO 'COUNTRY' A5 BIANCO PP 6L
28X18,5X12,6 CM ROTHO

UV1	UV2	IMBALLO
1	3	1/3 BK



7 6 1 0 8 5 9 1 2 3 8 4 8



ART	BARCODE	ST.	PREZZO
04 24 89	7610859221407		9,20

CESTO 'COUNTRY' A5+ ANTRACITE PP
11L 32,8X23,8X16 CM ROTHO

UV1	UV2	IMBALLO
1	3	1/3 BK



7 6 1 0 8 5 9 2 2 1 4 0 7



ART	BARCODE	ST.	PREZZO
04 24 90	7610859135858		9,20

CESTO 'COUNTRY' A5+ CAPPUCCINO PP
11L 32,8X23,8X16 CM ROTHO

UV1	UV2	IMBALLO
1	3	1/3 BK



7 6 1 0 8 5 9 1 3 5 8 5 8



ART	BARCODE	ST.	PREZZO
04 24 88	7610859135865		9,20

CESTO 'COUNTRY' A5+ BIANCO PP 11L
32,8X23,8X16 CM ROTHO

UV1	UV2	IMBALLO
1	3	1/3 BK



7 6 1 0 8 5 9 1 3 5 8 6 5

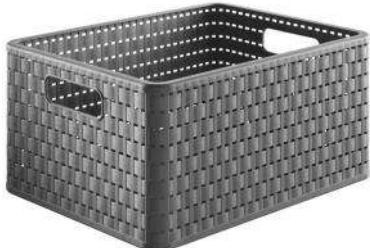

ART	BARCODE	ST.	PREZZO
04 24 95	7610859169273		12,70

CESTO 'COUNTRY' A4 ANTRACITE PP 18L
36.8X27.8X19 CM ROTHO

UV1	UV2	IMBALLO
1	3	1/3 BK



7 6 1 0 8 5 9 1 6 9 2 7 3



ART	BARCODE	ST.	PREZZO
04 24 96	7610859124425		12,70

CESTO 'COUNTRY' A4 CAPPUCCINO PP
18L 36.8X27.8X19 CM ROTHO

UV1	UV2	IMBALLO
1	3	1/3 BK



7 6 1 0 8 5 9 1 2 4 4 2 5



ART	BARCODE	ST.	PREZZO
04 24 94	7610859123824		12,70

CESTO 'COUNTRY' A4 BIANCO PP 18L
37X28X19 CM ROTHO

UV1	UV2	IMBALLO
1	3	1/3 BK



7 6 1 0 8 5 9 1 2 3 8 2 4



ART	BARCODE	ST.	PREZZO
04 24 82	7610859221292		31,50

CESTO BIANCHERIA 'COUNTRY' PP
BIANCO 55L 42X32X57 CM ROTHO

UV1	UV2	IMBALLO
1	4	1/4 HT



7 6 1 0 8 5 9 2 2 1 2 9 2



ART	BARCODE	ST.	PREZZO
04 25 05	7610859196705	H	6,00

CESTO 'BRISSEN' PP NERO 7L 26X18X21
CM ROTHO

UV1	UV2	IMBALLO
1	6	1/6 HT



7 6 1 0 8 5 9 1 9 6 7 0 5



ART	BARCODE	ST.	PREZZO
04 25 06	7610859196712	H	6,00

CESTO 'BRISSEN' PP CAPPUCCINO 7L
26X18X21 CM ROTHO

UV1	UV2	IMBALLO
1	6	1/6 HT



7 6 1 0 8 5 9 1 9 6 7 1 2



ART	BARCODE	ST.	PREZZO
04 25 07	7610859196088	A	9,50

CESTO 'BRISSEN' PP BIANCO 16L
36X26X21 CM ROTHO

UV1	UV2	IMBALLO
1	5	1/5 HT



7 6 1 0 8 5 9 1 9 6 0 8 8



ART	BARCODE	ST.	PREZZO
04 25 08	7610859196750	H	9,50

CESTO 'BRISSEN' PP NERO 16L 36X26X21
CM ROTHO

UV1	UV2	IMBALLO
1	5	1/5 HT



7 6 1 0 8 5 9 1 9 6 7 5 0



ART	BARCODE	ST.	PREZZO
04 25 09	7610859196767	H	9,50

CESTO 'BRISSEN' PP CAPPUCCINO 16L
36X26X21 CM ROTHO

UV1	UV2	IMBALLO
1	5	1/5 HT



7 6 1 0 8 5 9 1 9 6 7 6 7



ART	BARCODE	ST.	PREZZO
04 25 10	7610859196095	A	11,00

CESTO 'BRISEN' PP BIANCO 18L
29X29X28 CM ROTHO

UV1	UV2	IMBALLO
1	4	1/4 HT



7 6 1 0 8 5 9 1 9 6 0 9 5



ART	BARCODE	ST.	PREZZO
04 25 11*	7610859196804	H	11,00

CESTO 'BRISEN' PP NERO 18L 29X29X28
CM ROTHO

UV1	UV2	IMBALLO
1	4	1/4 HT



7 6 1 0 8 5 9 1 9 6 8 0 4



ART	BARCODE	ST.	PREZZO
04 25 12*	7610859196811	H	11,00

CESTO 'BRISEN' PP CAPPUCCINO 18L
29X29X28 CM ROTHO

UV1	UV2	IMBALLO
1	4	1/4 HT



7 6 1 0 8 5 9 1 9 6 8 1 1



ART	BARCODE	ST.	PREZZO
10 21 52*	4260375030811	H	27,50

BOX PIEGHEVOLE 'CLASSIC L'
ARANCIONE MANDARINO/MOM MEORI

UV1	UV2	IMBALLO
1	2	1/5/10 SL



4 2 6 0 3 7 5 0 3 0 8 1 1



ART	BARCODE	ST.	PREZZO
10 21 89*	4260375033140	H	12,50

BOX PIEGHEVOLE 'MINI DESIGN' LOVE
MEORI

UV1	UV2	IMBALLO
1	5	1/5/50 SL



4 2 6 0 3 7 5 0 3 3 1 4 0



ART	BARCODE	ST.	PREZZO
10 21 92*	4260375033102	H	12,50

BOX PIEGHEVOLE 'MINI DESIGN'
CUPCAKE MEORI

UV1	UV2	IMBALLO
1	5	1/5/50 SL



4 2 6 0 3 7 5 0 3 3 1 0 2



ART	BARCODE	ST.	PREZZO
10 21 93*	4260375033171	H	12,50

BOX PIEGHEVOLE 'MINI DESIGN'
CICOGNA MEORI

UV1	UV2	IMBALLO
1	5	1/5/50 SL



4 2 6 0 3 7 5 0 3 3 1 7 1



ART	BARCODE	ST.	PREZZO
10 21 97*	4260375033089	H	12,50

BOX PIEGHEVOLE 'MINI DESIGN'
PIPISTRELLI MEORI

UV1	UV2	IMBALLO
1	5	1/5/50 SL



4 2 6 0 3 7 5 0 3 3 0 8 9



ART	BARCODE	ST.	PREZZO
10 22 01*	4260375030415	H	10,00

COPERTURA IMPERMEABILE PER BOX
PIEGHEVOLE S MEORI

UV1	UV2	IMBALLO
1	2	1/5/20 WB



4 2 6 0 3 7 5 0 3 0 4 1 5



ART	BARCODE	ST.	PREZZO
10 22 02*	4260375031207	H	11,00

COPERTURA IMPERMEABILE PER BOX
PIEGHEVOLE M MEORI

UV1	UV2	IMBALLO
1	2	1/5/20 WB



4 2 6 0 3 7 5 0 3 1 2 0 7



ART	BARCODE	ST.	PREZZO
10 22 04*	4260375030439	H	11,00

COPERTURA IMPERMEABILE PER BOX
PIEGHEVOLE A4 MEORI

UV1	UV2	IMBALLO
1	2	1/5/20 SL



4 2 6 0 3 7 5 0 3 0 4 3 9



ART	BARCODE	ST.	PREZZO
10 22 11*	4260375032112	H	12,50

INSERTO PORTA-BOTTIGLIE PER BOX
PIEGHEVOLE M MEORI

UV1	UV2	IMBALLO
1	2	1/5/20 WB



4 2 6 0 3 7 5 0 3 2 1 1 2



ART	BARCODE	ST.	PREZZO
10 22 12	4260375032105	H	11,00

INSERTO PORTA-BOTTIGLIE PER BOX PIEGHEVOLE S/L MEORI

UV1	UV2	IMBALLO
1	2	1/5/20 WB



4 2 6 0 3 7 5 0 3 2 1 0 5



ART	BARCODE	ST.	PREZZO
10 22 13	4260375030460	H	16,50

INSERTO PIC NIC PER BOX PIEGHEVOLE S/M/L MEORI

UV1	UV2	IMBALLO
1	2	1/5/20 WB



4 2 6 0 3 7 5 0 3 0 4 6 0



ART	BARCODE	ST.	PREZZO
10 22 14	4260375031184	H	16,00

CINGHIA TRASPORTO PER BOX PIEGHEVOLE S/M/L MEORI

UV1	UV2	IMBALLO
1	2	1/5/20 WB



4 2 6 0 3 7 5 0 3 1 1 8 4



ART	BARCODE	ST.	PREZZO
10 22 16	4260375030477	H	4,60

SET 3 ETICHETTE PER BOX PIEGHEVOLE S/M/L MEORI

UV1	UV2	IMBALLO
1	2	1/100 PB



4 2 6 0 3 7 5 0 3 0 4 7 7



ART	BARCODE	ST.	PREZZO
04 36 00	8004537436006	A	3,30

BORSA PORTABOTTIGLIE 6 ASSORTITA EVA

UV1	UV2	IMBALLO
1	6	1/6/144 HT



8 0 0 4 5 3 7 4 3 6 0 0 6



ART	BARCODE	ST.	PREZZO
04 36 02	7610859153760		7,60

PORTABOTTIGLIE 'BASIC' PP 6 BOTTIGLIE 35X26X27 CM ROTHO

UV1	UV2	IMBALLO
1	3	1/3 BK



7 6 1 0 8 5 9 1 5 3 7 6 0



ART	BARCODE	ST.	PREZZO
04 37 11	4004094531880		3,90

10 GANCI VENTOSA ROTONDI TRASPARENTI Ø2CM WESTMARK

UV1	UV2	IMBALLO
1	10	1/10/70 BC



4 0 0 4 0 9 4 5 3 1 8 8 0



ART	BARCODE	ST.	PREZZO
04 37 12	4004094531989		2,50

3 GANCI VENTOSA ROTONDI TRASPARENTI Ø4CM WESTMARK

UV1	UV2	IMBALLO
1	5	1/5/70 BC



4 0 0 4 0 9 4 5 3 1 9 8 9



ART	BARCODE	ST.	PREZZO
04 37 13	4004094530586		1,90

2 GANCI ADESIVI OVALI BIANCHI 3X5X2CM WESTMARK

UV1	UV2	IMBALLO
1	5	1/5/80 BC



4 0 0 4 0 9 4 5 3 0 5 8 6



ART	BARCODE	ST.	PREZZO
04 37 14	4004094530685		2,25

3 GANCI ADESIVI OVALI BIANCHI 4X2X1,7CM WESTMARK

UV1	UV2	IMBALLO
1	5	1/5/100 BC



4 0 0 4 0 9 4 5 3 0 6 8 5



ART	BARCODE	ST.	PREZZO
04 37 15	4004094530784		2,35

3 GANCI ADESIVI OVALI BIANCHI 3X2X1CM WESTMARK

UV1	UV2	IMBALLO
1	5	1/5/100 BC



4 0 0 4 0 9 4 5 3 0 7 8 4



ART	BARCODE	ST.	PREZZO
04 37 16	4004094530289		2,50

4 GANCI ADESIVI ROTONDI BIANCHI Ø3,4X2CM WESTMARK

UV1	UV2	IMBALLO
1	5	1/5/70 BC



4 0 0 4 0 9 4 5 3 0 2 8 9



ART	BARCODE	ST.	PREZZO
04 37 17	4004094530272		3,50

4 GANCI ADESIVI ROTONDI CROMATI Ø3,4X2CM WESTMARK

UV1	UV2	IMBALLO
1	5	1/5/70 BC



4 0 0 4 0 9 4 5 3 0 2 7 2



ART	BARCODE	ST.	PREZZO
04 37 18	4004094530081		3,10

2 GANCI ADESIVI TRAPEZOIDALI CROMATI 5,5X4X2 CM WESTMARK

UV1	UV2	IMBALLO
1	10	1/10/70 BC



4 0 0 4 0 9 4 5 3 0 0 8 1



ART	BARCODE	ST.	PREZZO
04 37 20	4004094530180		3,20

3 GANCI ADESIVI TRAPEZOIDALI CROMATI 4X3X2 CM WESTMARK

UV1	UV2	IMBALLO
1	5	1/5/100 BC



4 0 0 4 0 9 4 5 3 0 1 8 0



ART	BARCODE	ST.	PREZZO
04 37 21	4004094530982		3,05

3 GANCI ADESIVI TRAPEZOIDALI CROMATI 3X2X1,5 CM WESTMARK

UV1	UV2	IMBALLO
1	5	1/5/100 BC



4 0 0 4 0 9 4 5 3 0 9 8 2



ART	BARCODE	ST.	PREZZO
04 37 61	8004537437614		6,40

CALZASCARPE ACCIAIO INOSSIDABILE 58 CM EVA

UV1	UV2	IMBALLO
1	5	1/25/75 PG



8 0 0 4 5 3 7 4 3 7 6 1 4



ART	BARCODE	ST.	PREZZO
04 19 70	4004094509551		1,30

ABBATTIMOSCHE 'FIORE' COLORI ASSORT PP/PE 48,5CM WESTMARK

UV1	UV2	IMBALLO
1	25	1/25/400 BK



4 0 0 4 0 9 4 5 0 9 5 5 1



ART	BARCODE	ST.	PREZZO
04 19 62	8000711007000		0,60

ABBATTIMOSCHE PLASTICA 45CM

UV1	UV2	IMBALLO
1	25	1/50/500 BK



8 0 0 0 7 1 1 0 0 7 0 0 0



ART	BARCODE	ST.	PREZZO
04 19 37	8004537419375		2,30

5 MOLLETTE APPENDISTROFINACCI 6 CM EVA

UV1	UV2	IMBALLO
1	12	1/60/600 BC



8 0 0 4 5 3 7 4 1 9 3 7 5



ART	BARCODE	ST.	PREZZO
11 05 15*	4000603109076	H	11,90

EVAPORATORE PLASTICA 21X32CM 850ML

UV1	UV2	IMBALLO
1	5	1/10 SP



4 0 0 0 6 0 3 1 0 9 0 7 6



ART	BARCODE	ST.	PREZZO
11 05 32	8008213900355		3,20

EVAPORATORE 'TOP' PIATTO BIANCO 8,5X20CM

UV1	UV2	IMBALLO
1	48	1/12/48 HB



8 0 0 8 2 1 3 9 0 0 3 5 5



ART	BARCODE	ST.	PREZZO
11 05 33	8008213900362		3,65

EVAPORATORE 'TOP' PIATTO FIORI 8,5X20CM

UV1	UV2	IMBALLO
1	48	1/12/48 HB



8 0 0 8 2 1 3 9 0 0 3 6 2



ART	BARCODE	ST.	PREZZO
11 05 37	8008213900102		4,40

EVAPORATORE 'CHIC' BIANCO 11,5X21,5CM

UV1	UV2	IMBALLO
1	24	1/12/24 HB



8 0 0 8 2 1 3 9 0 0 1 0 2



EUROPORZELLAN con gancio h 19,5 cm 8 Display 12 pz Porcellana Microporosa

ART	BARCODE	ST.	PREZZO
11 05 39	8008213900331		4,45

EVAPORATORE 'RETRO' INCASTRO BIANCO 8X19,5CM

UV1	UV2	IMBALLO
1	48	1/12/48 WB



8 0 0 8 2 1 3 9 0 0 3 3 1



EUROPORZELLAN con gancio cm 13,5 h 21,5 Display 8 pz Porcellana

ART	BARCODE	ST.	PREZZO
11 05 41	8008213500401	A	6,55

EVAPORATORE 'SLIM' BIANCO 13,5X21,5CM

UV1	UV2	IMBALLO
1	32	1/8/32 HB



8 0 0 8 2 1 3 5 0 0 4 0 1



EUROPORZELLAN cm 9 cm 24 cm 24 Porcellana

ART	BARCODE	ST.	PREZZO
11 05 45	8008213500289		5,00

EVAPORATORE VASCHETTA 'TAORMINA' BIANCO 6X9X24CM

UV1	UV2	IMBALLO
1	24	1/12/24 HB



8 0 0 8 2 1 3 5 0 0 2 8 9



ART	BARCODE	ST.	PREZZO
07 30 37	8004537730371	H	8,90

LANTERNA "STELLE" RAME 25 CM EVA

UV1	UV2	IMBALLO
1	6	1/12/36 PB



8 0 0 4 5 3 7 7 3 0 3 7 1



ART	BARCODE	ST.	PREZZO
07 30 39	4006822720375		7,40

LANTERNA RAME/NERO 25CM

UV1	UV2	IMBALLO
1	12	1/12 SP



4 0 0 6 8 2 2 7 2 0 3 7 5



ART	BARCODE	ST.	PREZZO
07 30 35	8004537730357	A	6,30

LANTERNA COLORI ASSORTITI 25 CM EVA

UV1	UV2	IMBALLO
1	12	1/12 SP



8 0 0 4 5 3 7 7 3 0 3 5 7



ART	BARCODE	ST.	PREZZO
04 79 38	4000270786013	A	27,50

ARMADIETTO PER MEDICINALI LEGNO FSC+VETRO 28X57X12 CM KESPER

UV1	UV2	IMBALLO
1	3	1/3 PB



4 0 0 0 2 7 0 7 8 6 0 1 3



ART	BARCODE	ST.	PREZZO
04 79 27	4000270177163		59,50

SCAFFALE FSC CON 9 CESTI IN TESSUTO 65X30X60 CM KESPER

UV1	UV2	IMBALLO
1	2	1/2 PB



4 0 0 0 2 7 0 1 7 7 1 6 3



ART	BARCODE	ST.	PREZZO
04 79 26	4000270177125		59,50

TAVOLINO PER BAMBINI CON 2 SEGGIOLE 55X55X45CM KESPER

UV1	UV2	IMBALLO
1	2	1/2 PB



4 0 0 0 2 7 0 1 7 7 1 2 5



ART	BARCODE	ST.	PREZZO
04 34 76	4000270776052		18,50

VASSOIO BAMBÙ FSC+PIEDI RIPIEGABILI 54,5X33CM KESPER

UV1	UV2	IMBALLO
1	5	1/5 SP



4 0 0 0 2 7 0 7 7 6 0 5 2



ART	BARCODE	ST.	PREZZO
04 79 36	4000270691027		7,50

CARRELLO PORTA-PIANTE IN LEGNO FSC 30X30X8 CM KESPER

UV1	UV2	IMBALLO
1	6	1/6 SL



4 0 0 0 2 7 0 6 9 1 0 2 7



ART	BARCODE	ST.	PREZZO
04 79 37	4000270691409		39,50

SCALA/SCAFFALE PORTA-PIANTE IN LEGNO FSC 43X110X40 CM KESPER

UV1	UV2	IMBALLO
1	3	1/3 LB



4 0 0 0 2 7 0 6 9 1 4 0 9



ART	BARCODE	ST.	PREZZO
04 79 40	4000270257766		69,50

CARRELLO BAMBU'/PIASTRELLE 4
RIPIANI 49X38X81CM KESPER

UV1	UV2	IMBALLO
1	2	1/1 PB



4 0 0 0 2 7 0 2 5 7 7 6 6



ART	BARCODE	ST.	PREZZO
04 79 35	4000270695810		53,50

CARRELLO FRUTTA/PATATE PINO FSC 3
PIANI 37X80X30CM KESPER

UV1	UV2	IMBALLO
1	2	1/1 LB



4 0 0 0 2 7 0 6 9 5 8 1 0



ART	BARCODE	ST.	PREZZO
04 79 45	4000270258053		127,50

CARRELO ABETE 1 CASSETTO+ANTA
51X40XH88CM KESPER

UV1	UV2	IMBALLO
1	2	1/1 PB



4 0 0 0 2 7 0 2 5 8 0 5 3



ART	BARCODE	ST.	PREZZO
04 79 43	4000270258145		65,00

CARRELLO ROVERE 4 PIANI + 1
CASSETTO 36X36X77CM KESPER

UV1	UV2	IMBALLO
1	2	1/2 PB



4 0 0 0 2 7 0 2 5 8 1 4 5



ART	BARCODE	ST.	PREZZO
04 79 44	4000270258060		75,00

CARRELLO GRANITO 4 PIANI
47X37X83CM KESPER

UV1	UV2	IMBALLO
1	2	1/1 PB



4 0 0 0 2 7 0 2 5 8 0 6 0



ART	BARCODE	ST.	PREZZO
04 79 49	4000270257513	A	69,50

CARRELLO PER SERVIRE 3 PIANI
69X40X82/90CM KESPER

UV1	UV2	IMBALLO
1	2	1/1 PB



4 0 0 0 2 7 0 2 5 7 5 1 3



ART	BARCODE	ST.	PREZZO
04 79 30	8004537479300	A	39,50

CARRELLO CROMATO 4 CESTINI EVA

UV1	UV2	IMBALLO
1	4	1/4 LB



8 0 0 4 5 3 7 4 7 9 3 0 0



ART	BARCODE	ST.	PREZZO
04 80 21	8004537480214	A	31,00

CARRELLO 4 RIPIANI CROMATO
40X32X97CM EVA

UV1	UV2	IMBALLO
1	3	1/3 LB



8 0 0 4 5 3 7 4 8 0 2 1 4



ART	BARCODE	ST.	PREZZO
04 80 23	8004537480238		36,00

CARRELLO 4 CASSETTI BIANCHI EVA

UV1	UV2	IMBALLO
1	2	1/2 LB



8 0 0 4 5 3 7 4 8 0 2 3 8



ART	BARCODE	ST.	PREZZO
04 80 24	8004537480245		36,50

CARRELLO 3 CASSETTI GRANDI+2
CASSETTI PICCOLI BIANCHI EVA

UV1	UV2	IMBALLO
1	2	1/2 LB



8 0 0 4 5 3 7 4 8 0 2 4 5



ART	BARCODE	ST.	PREZZO
04 29 21*	8004537429213	H	19,90

CARRELLO APPENDI-ABITI DOPPIO EVA

UV1	UV2	IMBALLO
1	3	1/3 LB



8 0 0 4 5 3 7 4 2 9 2 1 3



ART	BARCODE	ST.	PREZZO
04 32 84	4000270587108		25,70

CASSETTINA CUCITO BAMBU' FSC 6
SCOMPARTI 29X16X19 CM KESPER

UV1	UV2	IMBALLO
1	4	1/4 SL



4 0 0 0 2 7 0 5 8 7 1 0 8



ART	BARCODE	ST.	PREZZO
07 39 53	8004537739534		9,25

OROLOGIO DA MURO ABS Ø25CM EVA

UV1	UV2	IMBALLO
1	10	1/20 WB



8 0 0 4 5 3 7 7 3 9 5 3 4



ART	BARCODE	ST.	PREZZO
07 39 51	8004537739510		12,50

OROLOGIO DA MURO+TERMOMETRO+IGROMETRO Ø35CM EVA

UV1	UV2	IMBALLO
1	10	1/10 PB



8 0 0 4 5 3 7 7 3 9 5 1 0



ART	BARCODE	ST.	PREZZO
04 38 21	4004036863000		11,40

TERMOMETRO MIN/MAX 86300 PLASTICA 23CM KOCH

UV1	UV2	IMBALLO
1	5	1/25 HB



4 0 0 4 0 3 6 8 6 3 0 0 0



ART	BARCODE	ST.	PREZZO
04 38 14	4004036660005		8,50

TERMOMETRO ESTERNO 66000 ALLUMINIO 21CM KOCH

UV1	UV2	IMBALLO
1	10	1/20 HB



4 0 0 4 0 3 6 6 6 0 0 0 5

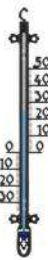

ART	BARCODE	ST.	PREZZO
04 38 13	4004036653274		2,90

TERMOMETRO ESTERNO 65327 PLASTICA 26CM KOCH

UV1	UV2	IMBALLO
1	20	1/20 HB



4 0 0 4 0 3 6 6 5 3 2 7 4



ART	BARCODE	ST.	PREZZO
04 38 11	4004036800005		2,35

TERMOMETRO ESTERNO 80000 BIANCO PLASTICA 20CM KOCH

UV1	UV2	IMBALLO
1	20	1/20 HB



4 0 0 4 0 3 6 8 0 0 0 0 5



ART	BARCODE	ST.	PREZZO
04 38 02	4004036161205		2,80

TERMOMETRO 16120 INTERNI LEGNO 20 CM KOCH

UV1	UV2	IMBALLO
1	10	1/20 HB



4 0 0 4 0 3 6 1 6 1 2 0 5



ART	BARCODE	ST.	PREZZO
04 25 82	4000270695773		14,90

SGABELLO LEGNO DI PINO FSC 42 X 21,5 X 20,5 CM KESPER

UV1	UV2	IMBALLO
1	4	1/4 AL



4 0 0 0 2 7 0 6 9 5 7 7 3



ART	BARCODE	ST.	PREZZO
04 47 74	9002427451022		3,95

TAPPETINO PER LEVELLO BIANCO 31X26.5 CM TEKO PLASTIC

UV1	UV2	IMBALLO
1	10	1/50 PG



9 0 0 2 4 2 7 4 5 1 0 2 2

Benessere



ART	BARCODE	ST.	PREZZO
11 07 01	8004537107012	A	92,50

SCALDIGLIA DI RAME

UV1	UV2	IMBALLO
1	2	1/1 SL



8 0 0 4 5 3 7 1 0 7 0 1 2



ART	BARCODE	ST.	PREZZO
11 07 14	4018833002227		33,50

SCALDIGLIA ZINCATA 26 CM

UV1	UV2	IMBALLO
1	4	1/8 SL



4 0 1 8 8 3 3 0 0 2 2 2 7



ART	BARCODE	ST.	PREZZO
11 07 35	4008339421400	A	10,20

BORSA ACQUA CALDA RICOP GREENLINE '67100' ASSORT. 2L FASHY

UV1	UV2	IMBALLO
1	5	1/15 HT



4 0 0 8 3 3 9 4 2 1 4 0 0



ART	BARCODE	ST.	PREZZO
11 09 01	4008339357044		7,20

BORSA ACQUA CALDA BILAMELLATA '6401' AZZURRA 0,8L FASHY

UV1	UV2	IMBALLO
1	5	1/20 HT



4 0 0 8 3 3 9 3 5 7 0 4 4



ART	BARCODE	ST.	PREZZO
11 09 55	4008339598454		8,40

BORSA ACQUA CALDA BILAMELLATA '6442' ASSORTITA 2L FASHY

UV1	UV2	IMBALLO
1	5	1/10/20 HT



4 0 0 8 3 3 9 5 9 8 4 5 4



ART	BARCODE	ST.	PREZZO
11 09 02	4008339357037		7,20

BORSA ACQUA CALDA SEMILAMELLATA '6401' ROSA 0,8L FASHY

UV1	UV2	IMBALLO
1	5	1/20 HT



4 0 0 8 3 3 9 3 5 7 0 3 7



ART	BARCODE	ST.	PREZZO
11 09 36	4008339420991		8,75

BORSA ACQUA CALDA BILAMELLARE '6460' BLU 2L FASHY

UV1	UV2	IMBALLO
1	5	1/20 HT



4 0 0 8 3 3 9 4 2 0 9 9 1



ART	BARCODE	ST.	PREZZO
11 09 37	4008339420984		8,75

BORSA ACQUA CALDA BILAMELLARE '6460' ROSSA 2L FASHY

UV1	UV2	IMBALLO
1	5	1/20 HT



4 0 0 8 3 3 9 4 2 0 9 8 4



ART	BARCODE	ST.	PREZZO
11 07 13	4012677136247		6,90

BORSA ACQUA CALDA BILAMELLARE ROSSA GOMMA 2L

UV1	UV2	IMBALLO
1	5	1/25 PH



4 0 1 2 6 7 7 1 3 6 2 4 7



ART	BARCODE	ST.	PREZZO
11 09 81*	4008339640887	H	8,60

BORSA ACQUA CALDA GOMMA CUORE '6410' ROSSO 0,7L FASHY

UV1	UV2	IMBALLO
1	5	1/10 HT

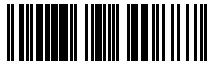

4 0 0 8 3 3 9 6 4 0 8 8 7



ART	BARCODE	ST.	PREZZO
11 09 82	4008339529540		10,50

BORSA ACQUA CALDA RICOPERTA CUORE '6522' ROSSO 0,7L FASHY

UV1	UV2	IMBALLO
1	5	1/10 HT



4 0 0 8 3 3 9 5 2 9 5 4 0



ART	BARCODE	ST.	PREZZO
11 09 64	4008339567832		17,10

BORSA ACQUA CALDA RICOPERTA MAGLIA '6715' VERDE 2L FASHY

UV1	UV2	IMBALLO
1	5	1/15 HT



4 0 0 8 3 3 9 5 6 7 8 3 2



ART	BARCODE	ST.	PREZZO
11 09 60	4008339595521		18,90

BORSA ACQUA CALDA RICOPERTA
MAGLIA '67352' ANTRACITE 2L FASH

UV1	UV2	IMBALLO
1	5	1/15 HT



4 0 0 8 3 3 9 5 9 5 5 2 1



ART	BARCODE	ST.	PREZZO
11 09 65	4008339567825	A	17,10

BORSA ACQUA CALDA RICOPERTA
MAGLIA '6715' BLU MARIN 2L FASHY

UV1	UV2	IMBALLO
1	5	1/15 HT



4 0 0 8 3 3 9 5 6 7 8 2 5



ART	BARCODE	ST.	PREZZO
11 09 63	4008339595538		18,90

BORSA ACQUA CALDA RICOPERTA
MAGLIA '67353' BLU 2L FASHY

UV1	UV2	IMBALLO
1	5	1/15 HT



4 0 0 8 3 3 9 5 9 5 5 3 8



ART	BARCODE	ST.	PREZZO
11 09 62	4008339595514		18,90

BORSA ACQUA CALDA RICOPERTA
MAGLIA '67351' BEIGE 2L FASHY

UV1	UV2	IMBALLO
1	5	1/15 HT



4 0 0 8 3 3 9 5 9 5 5 1 4



ART	BARCODE	ST.	PREZZO
11 09 61	4008339595507		18,90

BORSA ACQUA CALDA RICOPERTA
MAGLIA '67350' ARANCIONE 2L FASH

UV1	UV2	IMBALLO
1	5	1/15 HT



4 0 0 8 3 3 9 5 9 5 5 0 7



ART	BARCODE	ST.	PREZZO
11 09 66	4008339567818		17,10

BORSA ACQUA CALDA RICOPERTA
MAGLIA '6715' ROSSO 2L FASHY

UV1	UV2	IMBALLO
1	5	1/15 HT



4 0 0 8 3 3 9 5 6 7 8 1 8



ART	BARCODE	ST.	PREZZO
11 09 85	4008339567894	A	20,50

BORSA ACQUA CALDA RICOPERTA
MAGLIA '67334' GRIGIO 2L FASHY

UV1	UV2	IMBALLO
1	5	1/15 HT



4 0 0 8 3 3 9 5 6 7 8 9 4



ART	BARCODE	ST.	PREZZO
11 09 74	4008339596689		11,90

BORSA ACQUA CALDA RICOPERTA
CINIGLIA '6712' GIALLO 2L FASHY

UV1	UV2	IMBALLO
1	5	1/15 HT



4 0 0 8 3 3 9 5 9 6 6 8 9



ART	BARCODE	ST.	PREZZO
11 09 76	4008339359017		11,90

BORSA ACQUA CALDA RICOPERTA
CINIGLIA '6712' ARANCIO 2L FASHY

UV1	UV2	IMBALLO
1	5	1/15 HT



4 0 0 8 3 3 9 3 5 9 0 1 7



ART	BARCODE	ST.	PREZZO
11 09 71	4008339567795		11,90

BORSA ACQUA CALDA RICOPERTA
CINIGLIA '6712' ROSSO 2L FASHY

UV1	UV2	IMBALLO
1	5	1/15 HT



4 0 0 8 3 3 9 5 6 7 7 9 5



ART	BARCODE	ST.	PREZZO
11 09 73	4008339567801		11,90

BORSA ACQUA CALDA RICOPERTA
CINIGLIA '6712' VERDE 2L FASHY

UV1	UV2	IMBALLO
1	5	1/15 HT



4 0 0 8 3 3 9 5 6 7 8 0 1



ART	BARCODE	ST.	PREZZO
11 09 56	4008339421462		10,25

BORSA ACQUA CALDA RICOPERTA '6530'
BLU SAPHIR 2L FASHY

UV1	UV2	IMBALLO
1	5	1/15 HT



4 0 0 8 3 3 9 4 2 1 4 6 2



ART	BARCODE	ST.	PREZZO
11 09 57	4008339358805		10,25

BORSA ACQUA CALDA RICOPERTA '6530' ANTRACITE 2L FASHY

UV1	UV2	IMBALLO
1	5	1/15 HT



4 0 0 8 3 3 9 3 5 8 8 0 5



ART	BARCODE	ST.	PREZZO
11 09 58	4008339421455		10,25

BORSA ACQUA CALDA RICOPERTA '6530' ROSSO CRANBERRY 2L FASHY

UV1	UV2	IMBALLO
1	5	1/15 HT



4 0 0 8 3 3 9 4 2 1 4 5 5



ART	BARCODE	ST.	PREZZO
11 09 90	4008339595576	A	12,90

BORSA ACQUA CALDA RICO. LIBELLULE '67357' ARANCIONE 2L FASHY

UV1	UV2	IMBALLO
1	5	1/15 HT



4 0 0 8 3 3 9 5 9 5 5 7 6



ART	BARCODE	ST.	PREZZO
11 09 92	4008339595545		12,90

BORSA ACQUA CALDA RICO. STELLA '67354' ANTRACITE 2L FASHY

UV1	UV2	IMBALLO
1	5	1/15 HT



4 0 0 8 3 3 9 5 9 5 5 4 5



ART	BARCODE	ST.	PREZZO
11 09 07	4008339358799	A	9,95

BORSA ACQUA CALDA RICOPERTA '6505' AZZURRA 0,8L FASHY

UV1	UV2	IMBALLO
1	5	1/15 HT



4 0 0 8 3 3 9 3 5 8 7 9 9



ART	BARCODE	ST.	PREZZO
11 09 18*	4008339528048	H	12,50

BORSA ACQUA CALDA RICOPERTA '65204' BAMBINI 0,8L FASHY

UV1	UV2	IMBALLO
1	5	1/15 HT



4 0 0 8 3 3 9 5 2 8 0 4 8



ART	BARCODE	ST.	PREZZO
11 09 04	4008339595392		9,95

BORSA ACQUA CALDA RICOPERTA '6505' AZZURRA 0,8L FASHY

UV1	UV2	IMBALLO
1	5	1/15 HT



4 0 0 8 3 3 9 5 9 5 3 9 2



ART	BARCODE	ST.	PREZZO
11 09 05	4008339595385		9,95

BORSA ACQUA CALDA RICOPERTA '6505' ROSA 0,8L FASHY

UV1	UV2	IMBALLO
1	5	1/15 HT



4 0 0 8 3 3 9 5 9 5 3 8 5



ART	BARCODE	ST.	PREZZO
11 09 26	4008339461925		12,90

BORSA ACQUA CALDA RICOPERTA "CANE 65195" 0.8L FASHY

UV1	UV2	IMBALLO
1	5	1/15 HT



4 0 0 8 3 3 9 4 6 1 9 2 5



ART	BARCODE	ST.	PREZZO
11 09 86	4008339567665		12,90

BORSA ACQUA CALDA RICOP. PELLICCIA '67328' GRIGIO 2L FASHY

UV1	UV2	IMBALLO
1	5	1/15 HT



4 0 0 8 3 3 9 5 6 7 6 6 5



ART	BARCODE	ST.	PREZZO
11 09 88	4008339567689	A	17,90

BORSA ACQUA CALDA RICOP. PELLICCIA '67326' BEIGE 2L FASHY

UV1	UV2	IMBALLO
1	5	1/15 HT



4 0 0 8 3 3 9 5 6 7 6 8 9



ART	BARCODE	ST.	PREZZO
11 08 60*	4008339236806	H	8,50

CUSCINO TERMICO GEL MOOR 27X18 CM FASHY

UV1	UV2	IMBALLO
1	6	1/12 HB



4 0 0 8 3 3 9 2 3 6 8 0 6



ART	BARCODE	ST.	PREZZO
11 09 31	4008339567344		23,50

CUSCINO TERMICO SEMI COLZA
"ORSETTO BOBO 63033" 32X20CM FASHY

UV1	UV2	IMBALLO
1	5	1/5/20 HT



4 0 0 8 3 3 9 5 6 7 3 4 4



ART	BARCODE	ST.	PREZZO
11 07 48	4008339529892	A	14,50

CUSCINO TERMICO SILICONE 'CAPRETTA
WILSON' 22X24CM FASHY

UV1	UV2	IMBALLO
1	5	1/5/20 HT



4 0 0 8 3 3 9 5 2 9 8 9 2



ART	BARCODE	ST.	PREZZO
11 09 93	4008339489547		23,50

CUSCINO ACQUA CALDA
RICOPERTO+CINTURA '67204' BEIGE 2L
FASHY

UV1	UV2	IMBALLO
1	4	1/8 HB



4 0 0 8 3 3 9 4 8 9 5 4 7



ART	BARCODE	ST.	PREZZO
11 08 55	4008339489127	H	6,30

CUSCINO GEL MASCHERA OCCHI 63400
22X12 CM FASHY

UV1	UV2	IMBALLO
1	5	1/10/40 HB



4 0 0 8 3 3 9 4 8 9 1 2 7



ART	BARCODE	ST.	PREZZO
11 08 57	4008339489165	H	14,90

CUSCINO GEL SCHIENA 63402 45X15 CM
FASHY

UV1	UV2	IMBALLO
1	5	1/10 HB



4 0 0 8 3 3 9 4 8 9 1 6 5



ART	BARCODE	ST.	PREZZO
11 01 01	8004537101010	A	4,25

BORSA GHIACCIO TELA PLASTIFICATA
EVA

UV1	UV2	IMBALLO
1	6	1/48 HB



8 0 0 4 5 3 7 1 0 1 0 1 0



ART	BARCODE	ST.	PREZZO
07 07 18	8004537707182	H	17,50

6 OLIO ETERICO NATALIZIO ASSORTITO
10ML

UV1	UV2	IMBALLO
1	5	1/50 BX



8 0 0 4 5 3 7 7 0 7 1 8 2

Pezzi di ricambio
Ersatzteile
Spare parts



KAUFGUT[®]

Generici



ART	BARCODE	ST.	PREZZO
12 32 17	8004537232172	A	2,50

RICAMBIO MANICO CONNY SFUSO 6 TAZZE FOREVER

UV1	UV2	IMBALLO
1	5	1/1 BK



8 0 0 4 5 3 7 2 3 2 1 7 2



ART	BARCODE	ST.	PREZZO
12 32 16	8004537232165	A	2,00

RICAMBIO MANICO CONNY SFUSO 4 TAZZE FOREVER

UV1	UV2	IMBALLO
1	5	1/1 BK



8 0 0 4 5 3 7 2 3 2 1 6 5



ART	BARCODE	ST.	PREZZO
12 32 15	8004537232158	A	1,50

RICAMBIO MANICO CONNY SFUSO 2 TAZZE FOREVER

UV1	UV2	IMBALLO
1	5	1/1 BK



8 0 0 4 5 3 7 2 3 2 1 5 8



ART	BARCODE	ST.	PREZZO
12 32 12	8004537232127	A	1,90

RICAMBIO MANICO BIANCO MISS COCO NERA SFUSO 6 TAZZE FOREVER

UV1	UV2	IMBALLO
1	6	1/1 PG



8 0 0 4 5 3 7 2 3 2 1 2 7



ART	BARCODE	ST.	PREZZO
12 32 10	8004537232103	A	1,70

RICAMBIO MANICO BIANCO MISS COCO NERA SFUSO 3 TAZZE FOREVER

UV1	UV2	IMBALLO
1	6	1/1 PG



8 0 0 4 5 3 7 2 3 2 1 0 3



ART	BARCODE	ST.	PREZZO
12 32 08	8004537232080	A	1,50

RICAMBIO MANICO BIANCO MISS COCO NERA SFUSO 1 TAZZA FOREVER

UV1	UV2	IMBALLO
1	6	1/1 PG



8 0 0 4 5 3 7 2 3 2 0 8 0



ART	BARCODE	ST.	PREZZO
12 32 05	8004537232059	A	1,90

RICAMBIO MANICO NERO MISS COCO BIANCA SFUSO 6 TAZZE FOREVER

UV1	UV2	IMBALLO
1	6	1/1 PG



8 0 0 4 5 3 7 2 3 2 0 5 9



ART	BARCODE	ST.	PREZZO
12 32 03	8004537232035	A	1,70

RICAMBIO MANICO NERO MISS COCO BIANCA SFUSO 3 TAZZE FOREVER

UV1	UV2	IMBALLO
1	6	1/1 PG



8 0 0 4 5 3 7 2 3 2 0 3 5



ART	BARCODE	ST.	PREZZO
12 32 01	8004537232011	A	1,50

RICAMBIO MANICO NERO MISS COCO BIANCA SFUSO 1 TAZZA FOREVER

UV1	UV2	IMBALLO
1	6	1/1 PG



8 0 0 4 5 3 7 2 3 2 0 1 1



ART	BARCODE	ST.	PREZZO
12 31 75	n.d.	A	1,50

RICAMBIO GUARNIZIONE SILICONE SFUSA PRESTIGE 12TAZZE FOREVER

UV1	UV2	IMBALLO
1	6	1/100 BK



n . d



ART	BARCODE	ST.	PREZZO
12 31 71	8004537231717	A	0,65

RICAMBIO GUARNIZIONE SILICONE SFUSA PRESTIGE 6 TAZZE FOREVER

UV1	UV2	IMBALLO
100	300	1/100 BK



8 0 0 4 5 3 7 2 3 1 7 1 7



ART	BARCODE	ST.	PREZZO
12 31 68	8004537231687	A	0,60

RICAMBIO GUARNIZIONE SILICONE SFUSA PRESTIGE 3 TAZZE FOREVER

UV1	UV2	IMBALLO
100	300	1/100 BK



8 0 0 4 5 3 7 2 3 1 6 8 7



ART	BARCODE	ST.	PREZZO
12 31 65	8004537231656	A	0,55

RICAMBIO GUARNIZIONE SILICONE SFUSA PRESTIGE 2 TAZZE FOREVER

UV1	UV2	IMBALLO
100	300	1/100 BK



8 0 0 4 5 3 7 2 3 1 6 5 6



ART	BARCODE	ST.	PREZZO
12 31 62	8004537231625	A	0,50

RICAMBIO GUARNIZIONE SILICONE SFUSA PRESTIGE 1 TAZZA FOREVER

UV1	UV2	IMBALLO
100	300	1/100 BK



8 0 0 4 5 3 7 2 3 1 6 2 5



ART	BARCODE	ST.	PREZZO
12 31 38	0000001231380	A	1,30

RICAMBIO MANICO MISS PRESTIGE/EVOLUTION 2/3 TAZZE FOREVER

UV1	UV2	IMBALLO
1	6	1/1 BK



0 0 0 0 0 0 1 2 3 1 3 8 0



ART	BARCODE	ST.	PREZZO
12 31 36	0000001231366	A	1,00

RICAMBIO MANICO MISS MOKA PRESTIGE 1 TAZZA FOREVER

UV1	UV2	IMBALLO
1	6	1/1 BK



0 0 0 0 0 0 1 2 3 1 3 6 6



ART	BARCODE	ST.	PREZZO
12 31 20	0000001231205		0,05

RICAMBIO VITE SFUSA MANICO PRESTIGE FOREVER

UV1	UV2	IMBALLO
1	6	1/1 BK



0 0 0 0 0 0 1 2 3 1 2 0 5



ART	BARCODE	ST.	PREZZO
12 31 17	0000001231175	A	2,60

RICAMBIO MANICO SFUSO MISS INOX 6 TAZZE FOREVER

UV1	UV2	IMBALLO
1	6	1/1 BK



0 0 0 0 0 0 1 2 3 1 1 7 5



ART	BARCODE	ST.	PREZZO
12 31 10	0000001231106		0,05

RICAMBIO VITE SFUSA MANICO MISS INOX FOREVER

UV1	UV2	IMBALLO
1	6	1/1 BK



0 0 0 0 0 0 1 2 3 1 1 0 6



ART	BARCODE	ST.	PREZZO
12 15 96	n.d.		0,50

RICAMBIO POMOLO COPERCHIO SFUSO MISS ORZI 4 TAZZE FOREVER

UV1	UV2	IMBALLO
1	6	1/1 BK



n . d .



ART	BARCODE	ST.	PREZZO
12 15 95	n.d.		0,45

RICAMBIO POMOLO COPERCHIO SFUSO MISS ORZI 2 TAZZE FOREVER

UV1	UV2	IMBALLO
1	6	1/1 BK



n . d .



ART	BARCODE	ST.	PREZZO
12 15 93	0000001215939	A	0,75

RICAMBIO PIASTRINA FILTRO SFUSA MISS ORZI 2 TAZZE FOREVER

UV1	UV2	IMBALLO
1	6	1/1 BK



0 0 0 0 0 0 1 2 1 5 9 3 9



ART	BARCODE	ST.	PREZZO
12 15 88	8033237338464		3,25

RICAMBIO IMBUTO MISS ORZI 4 TAZZE FOREVER

UV1	UV2	IMBALLO
1	6	1/6/72 DC



8 0 3 3 2 3 7 3 3 8 4 6 4



ART	BARCODE	ST.	PREZZO
12 15 87	8033237338457		3,50

PIASTRINA FILTRO+1 GUARNIZIONI SILICONE ORZI 4T. FOREVER

UV1	UV2	IMBALLO
1	6	1/6/72 DC



8 0 3 3 2 3 7 3 3 8 4 5 7



ART	BARCODE	ST.	PREZZO
12 15 86	8033237338440		3,80

RICAMBIO MICROFILTRO MISS ORZI 4 TAZZE FOREVER

UV1	UV2	IMBALLO
1	6	1/6/72 DC



8 0 3 3 2 3 7 3 3 8 4 4 0



ART	BARCODE	ST.	PREZZO
12 15 85	8033237338495		2,70

RICAMBIO IMBUTO MISS ORZI 2 TAZZE FOREVER

UV1	UV2	IMBALLO
1	6	1/1 PG



8 0 3 3 2 3 7 3 3 8 4 9 5



ART	BARCODE	ST.	PREZZO
12 15 84	8033237338488		3,05

PIASTRINA FILTRO+1 GUARNIZIONI SILICONE ORZI 2T. FOREVER

UV1	UV2	IMBALLO
1	6	1/6/72 DC



8 0 3 3 2 3 7 3 3 8 4 8 8



ART	BARCODE	ST.	PREZZO
12 15 83	8033237338471		3,25

RICAMBIO MICROFILTRO MISS ORZI 2 TAZZE FOREVER

UV1	UV2	IMBALLO
1	6	1/6/72 DC



8 0 3 3 2 3 7 3 3 8 4 7 1



ART	BARCODE	ST.	PREZZO
12 15 65*	8033237338617	H	2,75

RICAMBIO IMBUTO PORTACAFFE MISS MARILYN/COMBIDUO FOREVER

UV1	UV2	IMBALLO
1	3	1/12 HB



8 0 3 3 2 3 7 3 3 8 6 1 7



ART	BARCODE	ST.	PREZZO
12 15 64*	8033237338624	H	6,90

PIASTRINA FILTRO+2 GUARNIZIONI SI MARILYN/COMBIDUO FOREVER

UV1	UV2	IMBALLO
1	3	1/1 DC



8 0 3 3 2 3 7 3 3 8 6 2 4



ART	BARCODE	ST.	PREZZO
12 15 63*	8033237338600	H	3,40

RICAMBIO BLISTER MANICO + VITE MISS MARILYN FOREVER

UV1	UV2	IMBALLO
1	3	1/36 DC



8 0 3 3 2 3 7 3 3 8 6 0 0



ART	BARCODE	ST.	PREZZO
12 15 14	8033237338570	A	4,60

2 IMBUTI MISS MOKA EVOLUTION 2 TAZZE FOREVER

UV1	UV2	IMBALLO
1	6	1/6/72 DC



8 0 3 3 2 3 7 3 3 8 5 7 0



ART	BARCODE	ST.	PREZZO
12 15 13	8033237338594	A	2,90

RICAMBIO FILTRO+2 GURANIZIONI SILICONE EVOLUTION 2T. FOREVER

UV1	UV2	IMBALLO
1	6	1/12/48 DC



8 0 3 3 2 3 7 3 3 8 5 9 4



ART	BARCODE	ST.	PREZZO
12 15 10	8033237338402	A	1,60

RICAMBIO IMBUTO PORTACIALDE ESE EVOLUTION 2 TAZZE FOREVER

UV1	UV2	IMBALLO
1	6	1/1 BK



8 0 3 3 2 3 7 3 3 8 4 0 2



ART	BARCODE	ST.	PREZZO
12 13 47	8033237338075		6,30

RICAMBIO BLISTER IMBUTO CONNY/SPLENDY INOX 10 TAZZE FOREVER

UV1	UV2	IMBALLO
1	6	1/6/72 DC



8 0 3 3 2 3 7 3 3 8 0 7 5



ART	BARCODE	ST.	PREZZO
12 13 46	8033237338051		5,80

RICAMBIO BLISTER IMBUTO CONNY/SPLENDY INOX 6 TAZZE FOREVER

UV1	UV2	IMBALLO
1	6	1/6/72 DC



8 0 3 3 2 3 7 3 3 8 0 5 1



ART	BARCODE	ST.	PREZZO
12 13 45	8033237338044		5,25

RICAMBIO BLISTER IMBUTO
CONNYS/SPLENDY INOX 4 TAZZE
FOREVER

UV1	UV2	IMBALLO
1	6	1/6/72 DC



8 0 3 3 2 3 7 3 3 8 0 4 4



ART	BARCODE	ST.	PREZZO
12 13 44	8033237338037		4,75

RICAMBIO BLISTER IMBUTO
CONNYS/SPLENDY INOX 2 TAZZE
FOREVER

UV1	UV2	IMBALLO
1	6	1/6/72 DC



8 0 3 3 2 3 7 3 3 8 0 3 7



ART	BARCODE	ST.	PREZZO
12 13 43	8033237338068		4,75

PIASTRINA FILTRO+2 GUARNIZIONI SI
CONNYS/SPLENDY 10T. FOREVER

UV1	UV2	IMBALLO
1	6	1/6/72 DC



8 0 3 3 2 3 7 3 3 8 0 6 8



ART	BARCODE	ST.	PREZZO
12 13 42	8033237338020		4,20

PIASTRINA FILTRO+2 GUARNIZIONI SI
CONNYS/SPLENDY 6T. FOREVER

UV1	UV2	IMBALLO
1	6	1/6/72 DC



8 0 3 3 2 3 7 3 3 8 0 2 0



ART	BARCODE	ST.	PREZZO
12 13 41	8033237338013		3,70

PIASTRINA FILTRO+2 GUARNIZIONI SI
CONNYS/SPLENDY 4T. FOREVER

UV1	UV2	IMBALLO
1	6	1/6/72 DC



8 0 3 3 2 3 7 3 3 8 0 1 3



ART	BARCODE	ST.	PREZZO
12 13 40	8033237338006		3,20

PIASTRINA FILTRO+2 GUAR SIL
CONNYS/SPLENDY 2TA FOREVER

UV1	UV2	IMBALLO
1	6	1/6/72 DC



8 0 3 3 2 3 7 3 3 8 0 0 6



ART	BARCODE	ST.	PREZZO
12 13 33	8033237339034		5,25

RICAMBIO BLISTER MANICO MISS
SPLENDY 10 TAZZE FOREVER

UV1	UV2	IMBALLO
1	6	1/6/72 DC



8 0 3 3 2 3 7 3 3 9 0 3 4



ART	BARCODE	ST.	PREZZO
12 13 32	8033237339027		4,75

RICAMBIO BLISTER MANICO MISS
SPLENDY 6 TAZZE FOREVER

UV1	UV2	IMBALLO
1	6	1/6/72 DC



8 0 3 3 2 3 7 3 3 9 0 2 7



ART	BARCODE	ST.	PREZZO
12 13 31	8033237339010		4,20

RICAMBIO BLISTER MANICO MISS
SPLENDY 4 TAZZE FOREVER

UV1	UV2	IMBALLO
1	6	1/6/72 DC



8 0 3 3 2 3 7 3 3 9 0 1 0



ART	BARCODE	ST.	PREZZO
12 13 30	8033237339003		3,70

RICAMBIO BLISTER MANICO MISS
SPLENDY 2 TAZZE FOREVER

UV1	UV2	IMBALLO
1	6	1/6/72 DC



8 0 3 3 2 3 7 3 3 9 0 0 3



ART	BARCODE	ST.	PREZZO
12 13 23	8033237339072		5,25

RICAMBIO BLISTER MANICO MISS
CONNYS 10TAZZE FOREVER

UV1	UV2	IMBALLO
1	6	1/6/72 DC



8 0 3 3 2 3 7 3 3 9 0 7 2



ART	BARCODE	ST.	PREZZO
12 13 22	8033237339065		4,75

RICAMBIO BLISTER MANICO MISS
CONNYS 6TAZZE FOREVER

UV1	UV2	IMBALLO
1	6	1/6/72 DC



8 0 3 3 2 3 7 3 3 9 0 6 5



ART	BARCODE	ST.	PREZZO
12 13 21	8033237339058		4,20

RICAMBIO BLISTER MANICO MISS CONNY 4TAZZE FOREVER

UV1	UV2	IMBALLO
1	6	1/6/72 DC



8 0 3 3 2 3 7 3 3 9 0 5 8



ART	BARCODE	ST.	PREZZO
12 13 20	8033237339041		3,70

RICAMBIO BLISTER MANICO MISS CONNY 2TAZZE FOREVER

UV1	UV2	IMBALLO
1	6	1/6/72 DC



8 0 3 3 2 3 7 3 3 9 0 4 1



ART	BARCODE	ST.	PREZZO
12 12 85	8033237338976	A	6,70

RICAMBIO BLISTER IMBUTO PORTACAFFE' INOX 10 TAZZE FOREVER

UV1	UV2	IMBALLO
1	6	1/6/72 BC



8 0 3 3 2 3 7 3 3 8 9 7 6



ART	BARCODE	ST.	PREZZO
12 12 84	8033237338952	A	3,80

RICAMBIO BLISTER IMBUTO PORTACAFFE' INOX 6 TAZZE FOREVER

UV1	UV2	IMBALLO
1	6	1/6/72 BC



8 0 3 3 2 3 7 3 3 8 9 5 2



ART	BARCODE	ST.	PREZZO
12 12 83	8033237338945	A	3,50

RICAMBIO BLISTER IMBUTO PORTACAFFE' INOX 4 TAZZE FOREVER

UV1	UV2	IMBALLO
1	6	1/6/72 BC



8 0 3 3 2 3 7 3 3 8 9 4 5



ART	BARCODE	ST.	PREZZO
12 12 82	8033237338938	A	3,20

RICAMBIO BLISTER IMBUTO PORTACAFFE' INOX 2 TAZZE FOREVER

UV1	UV2	IMBALLO
1	6	1/35 BC



8 0 3 3 2 3 7 3 3 8 9 3 8



ART	BARCODE	ST.	PREZZO
12 12 80	8033237338969	A	2,95

RICAMBIO PIASTRINA FILTRO+2 GUARNIZ. SI 10TAZZE INOX FOREVER

UV1	UV2	IMBALLO
1	6	1/12/48 DC



8 0 3 3 2 3 7 3 3 8 9 6 9



ART	BARCODE	ST.	PREZZO
12 12 77	8033237338907	A	1,75

RICAMBIO PIASTRINA FILTRO+2 GUARNIZ INOX 2 TAZZE FOREVER

UV1	UV2	IMBALLO
1	6	1/12/48 DC



8 0 3 3 2 3 7 3 3 8 9 0 7



ART	BARCODE	ST.	PREZZO
12 12 29	8033237338525	A	4,60

RICAMBIO BLISTER MANICO INOX + SILICONE 10 TAZZE FOREVER

UV1	UV2	IMBALLO
1	6	1/6/72 BC



8 0 3 3 2 3 7 3 3 8 5 2 5



ART	BARCODE	ST.	PREZZO
12 12 28	8033237338518	A	3,90

RICAMBIO BLISTER MANICO INOX + SILICONE 6 TAZZE FOREVER

UV1	UV2	IMBALLO
1	6	1/6/72 DC



8 0 3 3 2 3 7 3 3 8 5 1 8



ART	BARCODE	ST.	PREZZO
12 12 27	8033237338587	A	2,80

RICAMBIO BLISTER MANICO INOX + SILICONE 4 TAZZE FOREVER

UV1	UV2	IMBALLO
1	6	1/6/72 BC



8 0 3 3 2 3 7 3 3 8 5 8 7



ART	BARCODE	ST.	PREZZO
12 12 26	8033237338501	A	2,40

RICAMBIO BLISTER MANICO INOX + SILICONE 2 TAZZE FOREVER

UV1	UV2	IMBALLO
1	6	1/6/72 BC



8 0 3 3 2 3 7 3 3 8 5 0 1



ART	BARCODE	ST.	PREZZO
12 10 26	8033237338792		4,30
RICAMBIO BLISTER IMBUTO PORTACAFFE' ALLUMINIO 12 T. FOREVER			
UV1	UV2	IMBALLO	
1	6	1/100 BC	



ART	BARCODE	ST.	PREZZO
12 10 25	8033237338785		3,70
RICAMBIO BLISTER IMBUTO PORTACAFFE' ALLUMINIO 9 T. FOREVER			
UV1	UV2	IMBALLO	
1	6	1/100 BC	



ART	BARCODE	ST.	PREZZO
12 10 24	8033237338778		2,45
RICAMBIO BLISTER IMBUTO PORTACAFFE' ALLUMINIO 6 T. FOREVER			
UV1	UV2	IMBALLO	
1	6	1/672 DC	



ART	BARCODE	ST.	PREZZO
12 10 23	8033237338761		2,20
RICAMBIO BLISTER IMBUTO PORTACAFFE' ALLUMINIO 3 T. FOREVER			
UV1	UV2	IMBALLO	
1	6	1/672 DC	



ART	BARCODE	ST.	PREZZO
12 10 22	8033237338754		2,05
RICAMBIO BLISTER IMBUTO PORTACAFFE' ALLUMINIO 2 T. FOREVER			
UV1	UV2	IMBALLO	
1	6	1/672 DC	



ART	BARCODE	ST.	PREZZO
12 10 21	8033237338747		1,90
RICAMBIO BLISTER IMBUTO PORTACAFFE' ALLUMINIO 1 T. FOREVER			
UV1	UV2	IMBALLO	
1	6	1/672 DC	



ART	BARCODE	ST.	PREZZO
12 10 20	8033237338693		1,75
RICAMBIO BLISTER IMBUTO PORTACAFFE' ALLUMINIO 1/2 T. FOREVER			
UV1	UV2	IMBALLO	
1	6	1/672 DC	



ART	BARCODE	ST.	PREZZO
12 10 17	8033237338266	A	1,75
RICAMBIO PIASTRINA FILTRO ALLUMINIO 12 TAZZE FOREVER			
UV1	UV2	IMBALLO	
1	6	1/1 BK	



ART	BARCODE	ST.	PREZZO
12 10 16	8033237338259	A	1,30
RICAMBIO PIASTRINA FILTRO ALLUMINIO 9 TAZZE FOREVER			
UV1	UV2	IMBALLO	
1	6	1/1 BK	



ART	BARCODE	ST.	PREZZO
12 10 07	8033237338655		4,05
PIASTRINA FILTRO ALLUM.+2 GUARNIZIONI SILIC.12+18 T. FOREVER			
UV1	UV2	IMBALLO	
1	6	1/672 DC	



ART	BARCODE	ST.	PREZZO
12 10 06	8033237338648		3,60
PIASTRINA FILTRO ALLUMINIO+2 GUARNIZIONI SILIC. 9 T. FOREVER			
UV1	UV2	IMBALLO	
1	6	1/672 DC	



ART	BARCODE	ST.	PREZZO
12 10 05	8033237338730		2,75
PIASTRINA FILTRO ALLUMINIO+2 GUARNIZIONI SILIC. 6 T. FOREVER			
UV1	UV2	IMBALLO	
1	6	1/672 DC	



ART	BARCODE	ST.	PREZZO
12 10 04	8033237338723		2,50

**PIASTRINA FILTRO ALLUMINIO+2
GUARNIZIONI SILIC. 3 T. FOREVER**

UV1	UV2	IMBALLO
1	6	1/6/72 DC



8 0 3 3 2 3 7 3 3 8 7 2 3



ART	BARCODE	ST.	PREZZO
12 10 03	8033237338716		2,20

**PIASTRINA FILTRO ALLUMINIO+2
GUARNIZIONI SILIC. 2 T. FOREVER**

UV1	UV2	IMBALLO
1	6	1/6/72 DC



8 0 3 3 2 3 7 3 3 8 7 1 6



ART	BARCODE	ST.	PREZZO
12 10 02	8033237338709		2,00

**PIASTRINA FILTRO ALLUMINIO+2
GUARNIZIONI SILIC. 1T. FOREVER**

UV1	UV2	IMBALLO
1	6	1/6/72 DC



8 0 3 3 2 3 7 3 3 8 7 0 9



ART	BARCODE	ST.	PREZZO
12 10 01	8033237338686		1,85

**PIASTRINA FILTRO ALLUMINIO+2
GUARNIZIONI SILIC.1/2T. FOREVER**

UV1	UV2	IMBALLO
1	2	1/6/72 DC



8 0 3 3 2 3 7 3 3 8 6 8 6



ART	BARCODE	ST.	PREZZO
12 05 96	8033237338198	A	4,00

**RICAMBIO MANICO BIANCO MISS COCO
NERA 6 TAZZE FOREVER**

UV1	UV2	IMBALLO
1	6	1/6/72 DC



8 0 3 3 2 3 7 3 3 8 1 9 8



ART	BARCODE	ST.	PREZZO
12 05 95	8033237338181	A	3,50

**RICAMBIO MANICO BIANCO MISS COCO
NERA 3 TAZZE FOREVER**

UV1	UV2	IMBALLO
1	6	1/6/72 DC



8 0 3 3 2 3 7 3 3 8 1 8 1



ART	BARCODE	ST.	PREZZO
12 05 94	8033237338174	A	3,00

**RICAMBIO MANICO BIANCO MISS COCO
NERA 1 TAZZA FOREVER**

UV1	UV2	IMBALLO
1	6	1/6/72 DC



8 0 3 3 2 3 7 3 3 8 1 7 4



ART	BARCODE	ST.	PREZZO
12 05 93	8033237338297	A	4,00

**RICAMBIO MANICO NERO MISS COCO
BIANCA 6 TAZZE FOREVER**

UV1	UV2	IMBALLO
1	6	1/6/72 DC



8 0 3 3 2 3 7 3 3 8 2 9 7



ART	BARCODE	ST.	PREZZO
12 05 92	8033237338280	A	3,50

**RICAMBIO MANICO NERO MISS COCO
BIANCA 3 TAZZE FOREVER**

UV1	UV2	IMBALLO
1	6	1/6/72 DC



8 0 3 3 2 3 7 3 3 8 2 8 0



ART	BARCODE	ST.	PREZZO
12 05 91	8033237338273	A	3,00

**RICAMBIO MANICO NERO MISS COCO
BIANCA 1 TAZZA FOREVER**

UV1	UV2	IMBALLO
1	6	1/6/72 DC



8 0 3 3 2 3 7 3 3 8 2 7 3



ART	BARCODE	ST.	PREZZO
12 05 82	8033237338815	A	2,40

**RICAMBIO MANICO + VITE MISS COCO 2/3
TAZZE FOREVER**

UV1	UV2	IMBALLO
1	6	1/1 BC



8 0 3 3 2 3 7 3 3 8 8 1 5



ART	BARCODE	ST.	PREZZO
02 27 84	4000270699689		3,75

**8 SPATOLE RACLETTE LEGNO DI FAGGIO
FSC 13CM KESPER**

UV1	UV2	IMBALLO
1	10	1/10 PG



4 0 0 0 2 7 0 6 9 9 6 8 9



ART	BARCODE	ST.	PREZZO
02 61 53	4006160821932	A	14,90

10 SACCHETTI ASPIRAPOLVERE BS
973/974 BOMANN

UV1	UV2	IMBALLO
1	10	1/10 PB



4 0 0 6 1 6 0 8 2 1 9 3 2



ART	BARCODE	ST.	PREZZO
02 61 54	4006160822076	A	14,90

10 SACCHETTI ASPIRAPOLVERE CB993
BOMANN

UV1	UV2	IMBALLO
1	10	1/10 PB



4 0 0 6 1 6 0 8 2 2 0 7 6



ART	BARCODE	ST.	PREZZO
12 05 83	8033237338822	A	2,70

RICAMBIO MANICO + VITE MISS COCO 6
TAZZE FOREVER

UV1	UV2	IMBALLO
1	6	1/1 BC



8 0 3 3 2 3 7 3 3 8 8 2 2



ART	BARCODE	ST.	PREZZO
02 61 57	4006160276701	A	13,50

FILTRO POLVERE CB994 BOMANN

UV1	UV2	IMBALLO
1	5	1/10 PB



4 0 0 6 1 6 0 2 7 6 7 0 1



ART	BARCODE	ST.	PREZZO
12 05 81	8033237338808	A	2,20

RICAMBIO MANICO + VITE MISS COCO 1
TAZZA FOREVER

UV1	UV2	IMBALLO
1	6	1/1 BC



8 0 3 3 2 3 7 3 3 8 8 0 8



ART	BARCODE	ST.	PREZZO
12 05 77	n.d.	A	0,90

RICAMBIO POMOLO COP. SFUSO MISS
COCO NERO 6T. FOREVER

UV1	UV2	IMBALLO
1	6	1/6/72 BK



n d



ART	BARCODE	ST.	PREZZO
12 05 75	n.d.	A	0,70

RICAMBIO POMOLO COP. SFUSO MISS
COCO NERO 1/2/3T. FOREVER

UV1	UV2	IMBALLO
1	6	1/6/72 BK



n d



ART	BARCODE	ST.	PREZZO
12 05 73	n.d.	A	0,90

RICAMBIO POMOLO COP. SFUSO MISS
COCO BIANCO 6T. FOREVER

UV1	UV2	IMBALLO
1	6	1/6/72 BK



n d



ART	BARCODE	ST.	PREZZO
12 05 71	n.d.	A	0,70

RICAMBIO POMOLO COP. SFUSO MISS
COCO BIANCO 1/2/3T. FOREVER

UV1	UV2	IMBALLO
1	6	1/6/72 BK



n d



ART	BARCODE	ST.	PREZZO
12 05 64	n.d.	A	0,45

RICAMBIO POMOLO COPERCHERIO
SFUSO MISS COCO 6T. FOREVER

UV1	UV2	IMBALLO
1	6	1/6/72 BK



n d



ART	BARCODE	ST.	PREZZO
12 05 61	n.d.	A	0,40

RICAMBIO POMOLO COPERCHERIO
SFUSO MISS COCO 1/2/3T. FOREVER

UV1	UV2	IMBALLO
1	6	1/6/72 BK



n d



ART	BARCODE	ST.	PREZZO
12 03 92	n.d.	A	0,45

RICAMBIO POMOLO COPERCHERIO
SFUSO MISS TUTU' 6/9T. FOREVER

UV1	UV2	IMBALLO
1	6	1/6/72 BK



n d



ART	BARCODE	ST.	PREZZO
12 03 91	n.d.	A	0,40

RICAMBIO POMOLO COPERCHERIO SFUSO MISS TUTU' 1/2/3T. FOREVER

UV1	UV2	IMBALLO
1	6	1/1 BK



ART	BARCODE	ST.	PREZZO
12 03 84	8033237338860	A	2,30

RICAMBIO MANICO + VITE MISS TUTU' 9 TAZZE FOREVER

UV1	UV2	IMBALLO
1	6	1/1 BC



ART	BARCODE	ST.	PREZZO
12 03 83	8033237338853	A	2,60

RICAMBIO MANICO + VITE MISS TUTU' 6 TAZZE FOREVER

UV1	UV2	IMBALLO
1	6	1/6/72 BC



ART	BARCODE	ST.	PREZZO
12 03 82	8033237338846	A	2,30

RICAMBIO MANICO + VITE MISS TUTU' 2/3 TAZZE FOREVER

UV1	UV2	IMBALLO
1	6	1/1 BC



ART	BARCODE	ST.	PREZZO
12 03 81	8033237338839	A	2,10

RICAMBIO MANICO + VITE MISS TUTU' 1 TAZZA FOREVER

UV1	UV2	IMBALLO
1	6	1/1 BC



ART	BARCODE	ST.	PREZZO
12 02 93	n.d.		0,75

RICAMBIO POMOLO COP.SFUSO MOKA PRESTIGE 9/12 T. FOREVER

UV1	UV2	IMBALLO
1	6	1/1 BK



ART	BARCODE	ST.	PREZZO
12 02 92	8033237338812	A	0,60

RICAMBIO POMOLO COP.SFUSO MOKA PRESTIGE 3/6 T. FOREVER

UV1	UV2	IMBALLO
1	6	1/6 BK



ART	BARCODE	ST.	PREZZO
12 02 91	80332373388105	A	0,50

RICAMBIO POMOLO COP.SFUSO MOKA PRESTIGE 1/2+1+2 TA FOREVER

UV1	UV2	IMBALLO
1	6	1/12 BK



ART	BARCODE	ST.	PREZZO
12 02 05*	8033237338862	H	1,50

RICAMBIO MANICO MISS MOKA CON RIVETTO 9/12 TAZZE FOREVER

UV1	UV2	IMBALLO
1	2	1/6/72 BC



ART	BARCODE	ST.	PREZZO
12 02 04*	8033237338891	H	1,25

RICAMBIO MANICO MISS MOKA CON RIVETTO 6 TAZZE FOREVER

UV1	UV2	IMBALLO
1	2	1/6/72 BC



ART	BARCODE	ST.	PREZZO
12 02 03*	8033237338884	H	1,15

RICAMBIO MANICO MISS MOKA CON RIVETTO 3 TAZZE FOREVER

UV1	UV2	IMBALLO
1	2	1/6/72 BC



ART	BARCODE	ST.	PREZZO
12 02 02*	8033237338890	H	1,05

RICAMBIO MANICO MISS MOKA CON RIVETTO 2 TAZZE FOREVER

UV1	UV2	IMBALLO
1	2	1/6/72 BC





ART	BARCODE	ST.	PREZZO
12 01 85	8033237338563		3,15
RICAMBIO MANICO MISS MOKA PRESTIGE 9/12 TAZZE FOREVER			
UV1	UV2	IMBALLO	
1	6	1/6/72 DC	



8 0 3 3 2 3 7 3 3 8 5 6 3



ART	BARCODE	ST.	PREZZO
12 01 84	8033237338556		2,40
RICAMBIO MANICO MISS MOKA PRESTIGE 6 TAZZE FOREVER			
UV1	UV2	IMBALLO	
1	6	1/6/72 DC	



8 0 3 3 2 3 7 3 3 8 5 5 6



ART	BARCODE	ST.	PREZZO
12 01 83	8033237338549		2,05
RICAMBIO MANICO MISS MOKA PRESTIGE 2/3 TAZZE FOREVER			
UV1	UV2	IMBALLO	
1	6	1/6/72 DC	



8 0 3 3 2 3 7 3 3 8 5 4 9



ART	BARCODE	ST.	PREZZO
12 01 82	8033237338532		1,75
RICAMBIO MANICO MISS MOKA PRESTIGE 1 TAZZA FOREVER			
UV1	UV2	IMBALLO	
1	6	1/6/72 DC	



8 0 3 3 2 3 7 3 3 8 5 3 2



ART	BARCODE	ST.	PREZZO
12 01 81	8033237338679		1,65
RICAMBIO MANICO MISS MOKA PRESTIGE 1/2 TAZZA FOREVER			
UV1	UV2	IMBALLO	
1	6	1/6/72 DC	



8 0 3 3 2 3 7 3 3 8 6 7 9



ART	BARCODE	ST.	PREZZO
02 95 22	4001797461001	A	32,50
2 SETACCI ESSICCATORE WDA601 WECK			
UV1	UV2	IMBALLO	
1	2	1/1 LB	



4 0 0 1 7 9 7 4 6 1 0 0 1



ART	BARCODE	ST.	PREZZO
12 32 18	8004537232189	A	3,00
RICAMBIO MANICO CONNY SFUSO 10 TAZZE FOREVER			
UV1	UV2	IMBALLO	
1	5	1/1 BK	



8 0 0 4 5 3 7 2 3 2 1 8 9



025453 = 6pz vasetti di ricambio per 025452
6 Stk. Ersatzgläser für 025452

ART	BARCODE	ST.	PREZZO
02 54 53	4006160511253	A	16,50
6 VASETTI RICAMBIO 'JM1025CB' BOMANN			
UV1	UV2	IMBALLO	
1	2	1/4 PB	



4 0 0 6 1 6 0 5 1 1 2 5 3



ART	BARCODE	ST.	PREZZO
12 13 24	8033237335425		0,65
RICAMBIO POMOLO SFUSO MISS CONNY FOREVER			
UV1	UV2	IMBALLO	
1	6	1/6/72 BK	



8 0 3 3 2 3 7 3 3 5 4 2 5



ART	BARCODE	ST.	PREZZO
12 13 34	8033237335524		0,65
RICAMBIO POMOLO SFUSO MISS SPLENDY 2/4 TAZZE FOREVER			
UV1	UV2	IMBALLO	
1	6	1/6/72 BK	



8 0 3 3 2 3 7 3 3 5 5 2 4



ART	BARCODE	ST.	PREZZO
12 13 36	8033237335562		0,75
RICAMBIO POMOLO SFUSO MISS SPLENDY 6/10 TAZZE FOREVER			
UV1	UV2	IMBALLO	
1	6	1/6/72 BK	



8 0 3 3 2 3 7 3 3 5 5 6 2



ART	BARCODE	ST.	PREZZO
12 13 92	8033237339102	A	3,00
IMBUTO INOX INNOVA 6 TAZZE			
UV1	UV2	IMBALLO	
1	6	1/6 PG	



8 0 3 3 2 3 7 3 3 9 1 0 2



ART	BARCODE	ST.	PREZZO
12 13 95	8033237339089	A	2,50

PIASTRINA FILTRO+1 GUARNIZIONE SILICONE INNOVA

UV1	UV2	IMBALLO
1	6	1/6 PG



8 0 3 3 2 3 7 3 3 9 0 8 9



ART	BARCODE	ST.	PREZZO
12 13 96	8033237339096	A	2,50

MANICO INNOVA+VITE 6 TAZZE

UV1	UV2	IMBALLO
1	6	1/6 PG



8 0 3 3 2 3 7 3 3 9 0 9 6



ART	BARCODE	ST.	PREZZO
12 39 01	8033237339218		3,30

FILTRO INOX +2GUARNIZIONI SILIC DIAMOND 2TA

UV1	UV2	IMBALLO
1	6	1/1 PG



8 0 3 3 2 3 7 3 3 9 2 1 8



ART	BARCODE	ST.	PREZZO
12 39 02	8033237339225		3,70

FILTRO INOX +2GUARNIZIONI SILIC DIAMOND 4TA

UV1	UV2	IMBALLO
1	6	1/1 PG



8 0 3 3 2 3 7 3 3 9 2 2 5



ART	BARCODE	ST.	PREZZO
12 39 03	8033237339232		4,20

FILTRO INOX +2GUARNIZIONI SILIC DIAMOND 6TA

UV1	UV2	IMBALLO
1	6	1/1 PG



8 0 3 3 2 3 7 3 3 9 2 3 2



ART	BARCODE	ST.	PREZZO
12 39 04	8033237339249		4,75

FILTRO INOX +2GUARNIZIONI SILIC DIAMOND 10TA

UV1	UV2	IMBALLO
1	6	1/1 PG



8 0 3 3 2 3 7 3 3 9 2 4 9



ART	BARCODE	ST.	PREZZO
12 39 10	8033237339256		4,20

IMBUTO INOX MISS DIAMOND 2TAZZE

UV1	UV2	IMBALLO
1	6	1/30 PG



8 0 3 3 2 3 7 3 3 9 2 5 6



ART	BARCODE	ST.	PREZZO
12 39 11	8033237339263		4,75

IMBUTO INOX MISS DIAMOND 4TAZZE

UV1	UV2	IMBALLO
1	6	1/30 PG



8 0 3 3 2 3 7 3 3 9 2 6 3



ART	BARCODE	ST.	PREZZO
12 39 12	8033237339270		5,25

IMBUTO INOX MISS DIAMOND 6TAZZE

UV1	UV2	IMBALLO
1	6	1/30 PG



8 0 3 3 2 3 7 3 3 9 2 7 0



ART	BARCODE	ST.	PREZZO
12 39 13	8033237339287		5,80

IMBUTO INOX MISS DIAMOND 10TAZZE

UV1	UV2	IMBALLO
1	6	1/30 PG



8 0 3 3 2 3 7 3 3 9 2 8 7



ART	BARCODE	ST.	PREZZO
12 39 16	n.d.		0,85

GUARNIZIONE SILICONE SFUSA DIAMOND 2TAZZE

UV1	UV2	IMBALLO
1	6	1/6 BK



n . d .



ART	BARCODE	ST.	PREZZO
12 39 17	n.d.		1,05

GUARNIZIONE SILICONE SFUSA DIAMOND 4TAZZE

UV1	UV2	IMBALLO
1	6	1/6 BK



n . d .



ART	BARCODE	ST.	PREZZO
12 39 18	n.d.		1,35

GUARNIZIONE SILICONE SFUSA
DIAMOND 6TAZZE

UV1	UV2	IMBALLO
1	6	1/6 BK



ART	BARCODE	ST.	PREZZO
12 39 19	n.d.		1,60

GUARNIZIONE SILICONE SFUSA
DIAMOND 10TAZZE

UV1	UV2	IMBALLO
1	6	1/6 BK



ART	BARCODE	ST.	PREZZO
02 04 01	8004537204018	A	1,50

PIASTRINA FILTRO ALLUMINIO+2
GUARNIZIONI SILIC.1/2T. EVA

UV1	UV2	IMBALLO
1	6	1/6/72 DC



ART	BARCODE	ST.	PREZZO
02 04 02	8004537204025	A	1,55

PIASTRINA FILTRO ALLUMINIO+2
GUARNIZIONI SILIC. 1T. EVA

UV1	UV2	IMBALLO
1	6	1/6/72 DC



ART	BARCODE	ST.	PREZZO
02 04 03	8004537204032	A	1,70

PIASTRINA FILTRO ALLUMINIO+2
GUARNIZIONI SILIC. 2 T. EVA

UV1	UV2	IMBALLO
1	6	1/6/72 DC



ART	BARCODE	ST.	PREZZO
02 04 04	8004537204049	A	1,80

PIASTRINA FILTRO ALLUMINIO+2
GUARNIZIONI SILIC. 3 T. EVA

UV1	UV2	IMBALLO
1	6	1/6/72 DC



ART	BARCODE	ST.	PREZZO
02 04 05	8004537204056	A	2,00

PIASTRINA FILTRO ALLUMINIO+2
GUARNIZIONI SILIC. 6 T. EVA

UV1	UV2	IMBALLO
1	6	1/6/72 DC



ART	BARCODE	ST.	PREZZO
02 04 06	8004537204063	A	2,30

PIASTRINA FILTRO ALLUMINIO+2
GUARNIZIONI SILIC. 9 T. EVA

UV1	UV2	IMBALLO
1	6	1/6/72 DC



ART	BARCODE	ST.	PREZZO
02 04 07	8004537204070	A	2,60

PIASTRINA FILTRO ALLUMINIO+2
GUARNIZIONI SILIC.12 T. EVA

UV1	UV2	IMBALLO
1	6	1/6/72 DC



ART	BARCODE	ST.	PREZZO
02 04 11	8004537204117	A	1,40

RICAMBIO BLISTER IMBUTO
PORTACAFFE' ALLUMINIO 1/2 T. EVA

UV1	UV2	IMBALLO
1	6	1/6/72 DC



ART	BARCODE	ST.	PREZZO
02 04 12	8004537204124	A	1,45

RICAMBIO BLISTER IMBUTO
PORTACAFFE' ALLUMINIO 1 T. EVA

UV1	UV2	IMBALLO
1	6	1/6/72 DC



ART	BARCODE	ST.	PREZZO
02 04 13	8004537204131	A	1,55

RICAMBIO BLISTER IMBUTO
PORTACAFFE' ALLUMINIO 2 T. EVA

UV1	UV2	IMBALLO
1	6	1/6/72 DC





ART	BARCODE	ST.	PREZZO
02 04 14*	8004537204148	A	1,65

**RICAMBIO BLISTER IMBUTO
PORTACAFFE' ALLUMINIO 3 T. EVA**

UV1	UV2	IMBALLO
1	6	1/6/72 DC



8 0 0 4 5 3 7 2 0 4 1 4 8



ART	BARCODE	ST.	PREZZO
02 04 15*	8004537204155	A	1,80

**RICAMBIO BLISTER IMBUTO
PORTACAFFE' ALLUMINIO 6 T. EVA**

UV1	UV2	IMBALLO
1	6	1/6/72 DC



8 0 0 4 5 3 7 2 0 4 1 5 5



ART	BARCODE	ST.	PREZZO
02 04 16*	8004537204162	A	2,00

**RICAMBIO BLISTER IMBUTO
PORTACAFFE' ALLUMINIO 9 T. EVA**

UV1	UV2	IMBALLO
1	6	1/6/72 DC



8 0 0 4 5 3 7 2 0 4 1 6 2



ART	BARCODE	ST.	PREZZO
02 04 17*	8004537204179	A	2,40

**RICAMBIO BLISTER IMBUTO
PORTACAFFE' ALLUMINIO 12 T. EVA**

UV1	UV2	IMBALLO
1	6	1/6/72 DC



8 0 0 4 5 3 7 2 0 4 1 7 9



ART	BARCODE	ST.	PREZZO
02 04 20	8004537204209	A	0,50

**RICAMBIO MANICO+ RIVETTO MOKA EVA
1/2 + 1 TAZZA**

UV1	UV2	IMBALLO
1	12	1/12/12 PG



8 0 0 4 5 3 7 2 0 4 2 0 9



ART	BARCODE	ST.	PREZZO
02 04 21	8004537204216	A	0,70

**RICAMBIO MANICO+ RIVETTO MOKA EVA
2 + 3 TAZZE**

UV1	UV2	IMBALLO
1	12	1/12/12 PG



8 0 0 4 5 3 7 2 0 4 2 1 6



ART	BARCODE	ST.	PREZZO
02 04 22	8004537204223	A	1,20

**RICAMBIO MANICO+ RIVETTO MOKA EVA
6 TAZZE**

UV1	UV2	IMBALLO
1	12	1/12/12 PG



8 0 0 4 5 3 7 2 0 4 2 2 3



ART	BARCODE	ST.	PREZZO
02 04 23	8004537204230	A	1,50

**RICAMBIO MANICO+ RIVETTO MOKA EVA
9 + 12 TAZZE**

UV1	UV2	IMBALLO
1	12	1/12/12 PG



8 0 0 4 5 3 7 2 0 4 2 3 0



ART	BARCODE	ST.	PREZZO
02 04 24	8004537204247	A	0,40

**RICAMBIO POMOLO COPERCHIO MOKA
EVA 1/2-1-2-3 TAZZE**

UV1	UV2	IMBALLO
1	12	1/12 PG



8 0 0 4 5 3 7 2 0 4 2 4 7



ART	BARCODE	ST.	PREZZO
12 07 13	8033237331960		9,20

**RICAMBIO BASE PER 6 TAZZE ELECTRO
FOREVER**

UV1	UV2	IMBALLO
1	12	1/20 PG



8 0 3 3 2 3 7 3 3 1 9 6 0



ART	BARCODE	ST.	PREZZO
12 07 12	8033237331953		0,55

**RICAMBIO RIDUTTORE IMBUTO
ALLUMINIO 3 TAZZE ELECTRO FOREVER**

UV1	UV2	IMBALLO
1	6	1/1 PG



8 0 3 3 2 3 7 3 3 1 9 5 3



ART	BARCODE	ST.	PREZZO
12 07 11	8033237331946		2,70

**RICAMBIO IMBUTO 6TA+RIDUTTORE 3TA
ALU ELECTRO FOREVER**

UV1	UV2	IMBALLO
1	6	1/6/72 DC



8 0 3 3 2 3 7 3 3 1 9 4 6



ART	BARCODE	ST.	PREZZO
12 07 10	8033237331939		3,25

PIASTRINA FILTRO ALLU+2 GUARNIZIONI SIL. 6TA ELECTRO FOREVER

UV1	UV2	IMBALLO
1	6	1/6/72 DC



8 0 3 3 2 3 7 3 3 1 9 3 9



ART	BARCODE	ST.	PREZZO
12 02 85	8033237339133		1,85

RICAMBIO MANICO SFUSO MOKA WOODY 1 TAZZA FOREVER

UV1	UV2	IMBALLO
1	6	1/6 PG



8 0 3 3 2 3 7 3 3 9 1 3 3



ART	BARCODE	ST.	PREZZO
12 02 86	8033237339140		2,20

RICAMBIO MANICO SFUSO MOKA WOODY 2+3 TAZZE FOREVER

UV1	UV2	IMBALLO
1	6	1/6 PG



8 0 3 3 2 3 7 3 3 9 1 4 0



ART	BARCODE	ST.	PREZZO
12 02 87	8033237339157		2,50

RICAMBIO MANICO SFUSO MOKA WOODY 6 TAZZE FOREVER

UV1	UV2	IMBALLO
1	6	1/6 PG



8 0 3 3 2 3 7 3 3 9 1 5 7



ART	BARCODE	ST.	PREZZO
12 02 88	8033237339164		0,60

RICAMBIO POMOLO COPERCHIO SFUSO MOKA WOODY FOREVER

UV1	UV2	IMBALLO
1	6	1/6 BK



8 0 3 3 2 3 7 3 3 9 1 6 4



ART	BARCODE	ST.	PREZZO
12 01 86	8033237339119		3,30

RICAMBIO MANICO MISS MOKA PRESTIGE 18 TAZZE FOREVER

UV1	UV2	IMBALLO
1	6	1/6 PG



8 0 3 3 2 3 7 3 3 9 1 1 9



ART	BARCODE	ST.	PREZZO
12 10 27	8033237339126		4,50

RICAMBIO SACCHETT IMBUTO PORTACAFFE' ALLUMINIO 18 T. FOREVER

UV1	UV2	IMBALLO
1	6	1/6/48 PG



8 0 3 3 2 3 7 3 3 9 1 2 6



ART	BARCODE	ST.	PREZZO
12 02 81	8033237339171		2,40

RICAMBIO MANICO SFUSO MOKA RADICA 1 TAZZA FOREVER

UV1	UV2	IMBALLO
1	6	1/1 PG



8 0 3 3 2 3 7 3 3 9 1 7 1



ART	BARCODE	ST.	PREZZO
12 02 82	8033237339188		2,50

RICAMBIO MANICO SFUSO MOKA RADICA 2+3 TAZZE FOREVER

UV1	UV2	IMBALLO
1	6	1/1 PG



8 0 3 3 2 3 7 3 3 9 1 8 8



ART	BARCODE	ST.	PREZZO
12 02 83	8033237339195		2,70

RICAMBIO MANICO SFUSO MOKA RADICA 6 TAZZE FOREVER

UV1	UV2	IMBALLO
1	6	1/1 PG



8 0 3 3 2 3 7 3 3 9 1 9 5



ART	BARCODE	ST.	PREZZO
12 02 84	8033237339201		0,80

RICAMBIO POMOLO COPERCHIO SFUSO MOKA RADICA FOREVER

UV1	UV2	IMBALLO
1	6	1/1 PG



8 0 3 3 2 3 7 3 3 9 2 0 1



ART	BARCODE	ST.	PREZZO
12 98 01	8033237337320		0,95

RICAMBIO TAPPO INOX BOTTIGLIA ISO 122240 FOREVER

UV1	UV2	IMBALLO
1	2	1/100 PG



8 0 3 3 2 3 7 3 3 7 3 2 0



ART	BARCODE	ST.	PREZZO
12 13 60	8033237335630		4,70

RICAMBIO MANICO+POMOLO MISS PERLA 4 TAZZE FOREVER

UV1	UV2	IMBALLO
1	6	1/1 PG



8 0 3 3 2 3 7 3 3 5 6 3 0



ART	BARCODE	ST.	PREZZO
12 13 66	8033237335692		5,25

RICAMBIO IMBUTO PERLA INOX 6 TAZZE FOREVER

UV1	UV2	IMBALLO
1	6	1/1 PG



8 0 3 3 2 3 7 3 3 5 6 9 2



ART	BARCODE	ST.	PREZZO
12 13 65	8033237335685		4,75

RICAMBIO IMBUTO PERLA INOX 4 TAZZE FOREVER

UV1	UV2	IMBALLO
1	6	1/1 PG



8 0 3 3 2 3 7 3 3 5 6 8 5



ART	BARCODE	ST.	PREZZO
12 13 63	8033237335661		3,70

PIASTRINA FILTRO+2 GUARNIZIONI SILCONE PERLA 6 TAZZE FOREVER

UV1	UV2	IMBALLO
1	6	1/1 PG



8 0 3 3 2 3 7 3 3 5 6 6 1



ART	BARCODE	ST.	PREZZO
12 13 62	8033237335654		3,20

PIASTRINA FILTRO+2 GUARNIZIONI SILCONE PERLA 4 TAZZE FOREVER

UV1	UV2	IMBALLO
1	6	1/1 PG



8 0 3 3 2 3 7 3 3 5 6 5 4



ART	BARCODE	ST.	PREZZO
12 13 61	8033237335647		5,20

RICAMBIO MANICO+POMOLO MISS PERLA 6-10 TAZZE FOREVER

UV1	UV2	IMBALLO
1	6	1/1 PG



8 0 3 3 2 3 7 3 3 5 6 4 7



ART	BARCODE	ST.	PREZZO
12 13 64	8033237335678		4,20

PIASTRINA FILTRO+2 GUARNIZIONI SILCONE PERLA 10 TAZZE FOREVER

UV1	UV2	IMBALLO
1	6	1/1 PG



8 0 3 3 2 3 7 3 3 5 6 7 8



ART	BARCODE	ST.	PREZZO
12 13 67	8033237335715		5,80

RICAMBIO IMBUTO PERLA INOX 10 TAZZE FOREVER

UV1	UV2	IMBALLO
1	6	1/1 PG



8 0 3 3 2 3 7 3 3 5 7 1 5



ART	BARCODE	ST.	PREZZO
02 61 52	4004470095593	A	9,90

FILTRO POLVERE CB955 BOMANN

UV1	UV2	IMBALLO
1	10	1/10 PB



4 0 0 4 4 7 0 0 9 5 5 9 3



ART	BARCODE	ST.	PREZZO
02 43 08	4015067999958	A	17,50

4 RICAMBIO BECCUCCI PER IRRIGATORE MD5613 AEG

UV1	UV2	IMBALLO
1	10	1/10/30 BC



4 0 1 5 0 6 7 9 9 9 9 5 8



ART	BARCODE	ST.	PREZZO
02 43 03	4015067999972	A	16,50

4 PEZZI RICAMBIO TESTINE PER EZ5501 AEG

UV1	UV2	IMBALLO
1	10	1/10/30 BC



4 0 1 5 0 6 7 9 9 9 9 7 2



ART	BARCODE	ST.	PREZZO
02 42 11	4006160632583	A	17,50

RICAMBIO CARTUCCIA ANTICALCARE 'DBS778CB' BOMANN

UV1	UV2	IMBALLO
1	3	1/3/12 PB



4 0 0 6 1 6 0 6 3 2 5 8 3



ART	BARCODE	ST.	PREZZO
02 43 11	4015067999941	A	14,50

4 RICAMBI SPAZZOLINI EZ5622 AEG

UV1	UV2	IMBALLO
1	5	1/10 DC



ART	BARCODE	ST.	PREZZO
02 61 51	8004537261516	A	14,90

10 SACCHETTI ASPIRAPOLVERE
CB949/957/969/985/961 BOMANN

UV1	UV2	IMBALLO
1	10	1/10 PB



ART	BARCODE	ST.	PREZZO
02 04 25	8004537204254	A	0,60

RICAMBIO POMOLO COPERCHIO MOKA
EVA 6-9-12 TAZZE

UV1	UV2	IMBALLO
1	12	1/12 PG



Pezzi di ricambio
Ersatzteile
Spare parts



KAUFGUT[®]

FUORI CATALOGO



ART	BARCODE	ST.	PREZZO
04 99 99	n.d.		0,01

CATALOGO KAUFGUT 2021

UV1	UV2	IMBALLO
1	1	1/16 BK

